

Logic Analyzer

GLA-1016/1032/1132

USER MANUAL

REVISION 1.0 June 2012



ISO-9001 CERTIFIED MANUFACTURER

GW INSTEK

This manual contains proprietary information, which is protected by copyrights. All rights are reserved. No part of this manual may be photocopied, reproduced or translated to another language without prior written consent of Good Will company.

The information in this manual was correct at the time of printing. However, Good Will continues to improve products and reserves the rights to change specification, equipment, and maintenance procedures at any time without notice.

Good Will Instrument Co., Ltd.

No. 7-1, Jhongsing Rd., Tucheng Dist., New Taipei City 236, Taiwan.

Table of Contents

Safety Instructions	5
GLA Overview.....	6
Main Features	7
Package Contents.....	8
Panel Overview	9
Display Overview	11
Operation Shortcuts.....	16
Installation	20
Software Installation	21
Power Up	26
Functionality Check.....	28
File Operation	29
Open/Close.....	30
Save	32
Printout.....	36
Handling Multiple Files	37
Bus/Signal Setup.....	39
Sampling/Compression Setup.....	40
Signal/Bus setup.....	43
Trigger Setup	47
Signal Triggering Condition Setup.....	48
Bus Triggering Condition Setup	51
General Triggering Properties Setup	53
Enable Trigger Function Setup	57
Trigger Output Signal.....	61

Display Setup	62
Toolbar Setup	63
Horizontal/Vertical Scale Setup	65
Signal Display Setup	67
Color Setup	71
Signal Capturing	74
Data Operation	76
Data Bar Operation	77
Waveform Position	81
Data Search.....	83
Zoom In/Out.....	87
I ² C Bus Analysis	90
RS-232C Signal Analysis	94
Waveform Statistics.....	97
System Setting.....	100
Keyboard Shortcut Setup	100
System Information.....	102
Help Information.....	103
FAQ	105
Specification	107
Index	109

Safety Instructions

This chapter contains important safety instructions that must be followed when operating GLA and when keeping it in storage. Read the following before any operation to insure safety and to keep the best condition for GLA.

Symbols and Guidelines

Symbol Caution symbol identifies conditions or practices that could result in damage to GLA or to other properties.



CAUTION

General Guideline

- Do not place any heavy object on GLA.
- Avoid severe impacts or rough handling that leads to damaging GLA.



CAUTION

- Do not discharge static electricity to GLA.
 - Do not disassemble GLA unless you are qualified as service personnel.
-

Cleaning GLA

- Use a soft cloth dampened in a solution of mild detergent and water. Do not spray any liquid into GLA.
- Do not use chemicals or cleaners containing harsh materials such as benzene, toluene, xylene, and acetone.

Operation Environment Location: Indoor, no direct sunlight, dust free, almost non-conductive pollution (Note below)



WARNING

- Relative Humidity: < 80%
 - Altitude: < 2000m
 - Temperature: 0°C to 50°C
-

Storage Environment Location: Indoor

- Relative Humidity: < 80%
- Temperature: -40°C to 80°C

GLA Overview

This chapter describes GLA series features and appearances in a nutshell. Use the Package Contents section to check if there is any missing component.

Main features	Series lineup	7
	Characteristics	7
Package contents	Package Contents	8
Panel overview	Panel Overview	9
	Input Connector	10
Display overview	Menu bar.....	11
	Tool bar	12
	Horizontal measurement bar	14
	Bus/Signal and Trigger list	15
Operation shortcuts	File menu	16
	Bus/Signal menu.....	16
	Trigger menu	17
	Run/Stop menu	17
	Data menu	17
	Tools menu	19
	Window menu	19
	Help menu	19

Main Features

Series lineup

- GLA-1016: 16 channels, 256Kbit/channel
 - GLA-1032: 32 channels, 128Kbit/channel
 - GLA-1132: 32 channels, 1Mbit/channel
-

Characteristics

- 100MHz full bandwidth
- Internal clock range: 100Hz ~ 200MHz
- External clock range: 0.001Hz ~ 100MHz
- Rich trigger functionalities: voltage level, count, page, position, delay time and clock, edge and level configuration
- Memory utilization: max. x255 ratio data compression
- Signal characteristic filtering: Enable function
- Various signal display mode: waveform, listing, time, frequency, and address
- I²C, RS-232C waveform analyzer
- Waveform statistics function
- Compact, lightweight profile
- PC operation with GUI environment
- Fast communication: USB 2.0, 1.1 compatible
- USB bus powered
- Various file export: operation setting, waveform data, display image

Package Contents

Check the contents before using GLA series. Contact your local dealer in case there is a missing item.

Carrying case contents

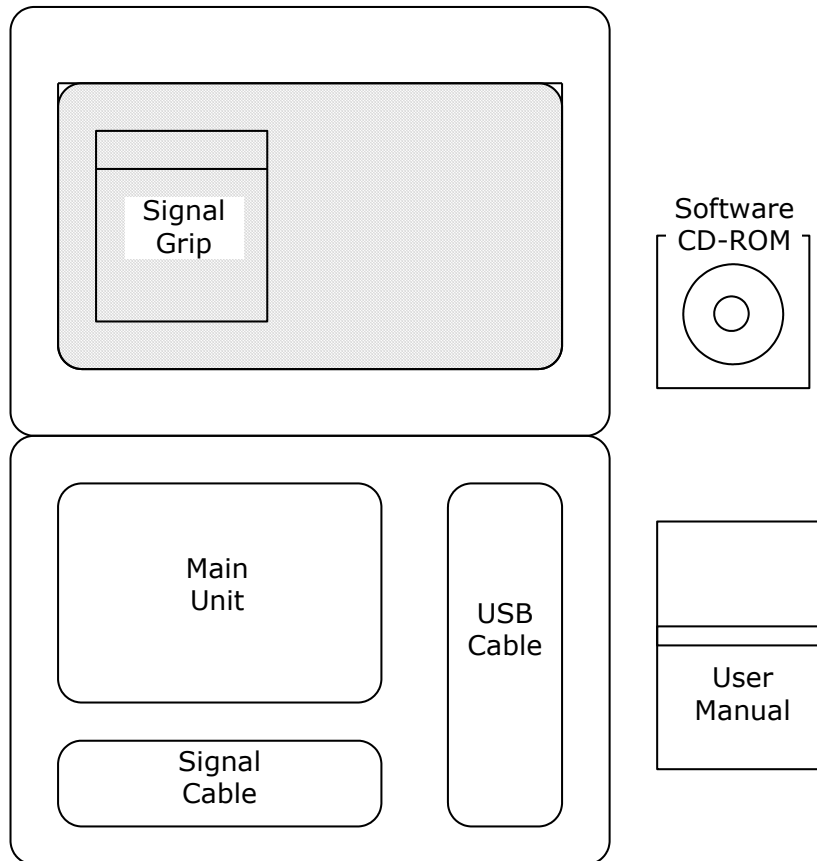

- | | |
|----------|--|
| GLA-1016 | <ul style="list-style-type: none"> • Signal Cable: 8pin*2, 2pin*1, 1pin*1, 250mm • Signal Grip: 20pcs |
| GLA-1032 | <ul style="list-style-type: none"> • Signal Cable: 16pin*1, 8pin*2, 2pin*1, 1pin*1, 250mm • Signal Grip: 36pcs |
| GLA-1132 | <ul style="list-style-type: none"> • Signal Cable: 16pin*1, 8pin*2, 2pin*1, 1pin*1, 250mm • Signal Grip: 36pcs |

Panel Overview



USB Connector For power input (USB bus) and communication between the PC. USB 1.1/2.0 compatible.



USB2.0 is strongly recommended for smooth display update. Make sure the cable is also compatible with 2.0 high speed (use the attached cable).

Power Switch Switch On : LED On (red)

Power LED Switch Off : LED Off



Trigger LED Turns On when the trigger condition is met. For details, see page61 (LED details), page47 (trigger in general).

Read LED Turns On when GLA transmit waveform data to PC. For details, see page61.

Run LED Turns On when GLA is waiting for trigger condition. For details, see page61.

Start Switch Triggers signal capturing. This is the same functionality as the Single Run . For Run/Stop details, see page74.

Input Connector

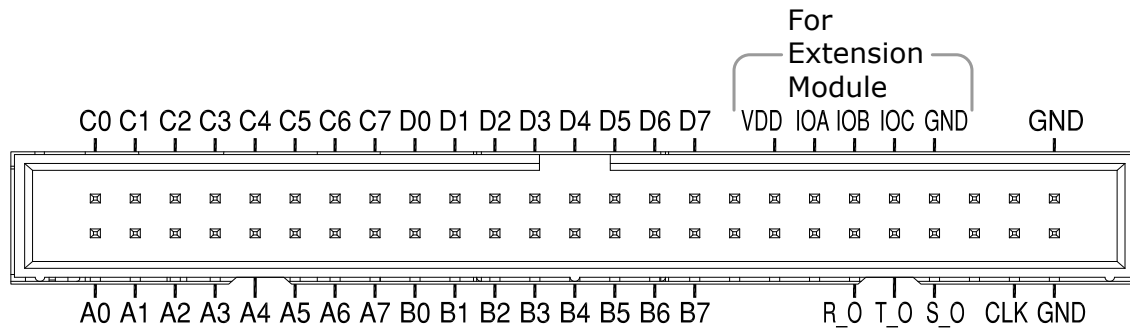

A0~D7 Signal input terminal. C0 ~ C7, D0 ~ D7 are not applicable to GLA-1016.

VDD, IOA/B/C, GND +3.3V power, IO port, GND terminal for extension module.



Do not use these connectors other than extension module usage purpose.

R_O, T_O, S_O Output signals for monitoring data capturing and trigger timing. Read output (R_O) indicates waveform data is transferred to PC, Trigger output (T_O) indicates trigger condition has occurred, and Start output (S_O) indicates GLA started waiting for trigger condition. For details, see page61.

CLK External (synchronous) clock signal input, 0.001Hz ~ 100MHz. For details, see page41.

GND Ground terminal.



We strongly recommend connecting both two Ground terminals to ensure stable data capturing.

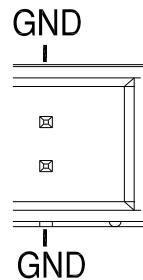

Display Overview

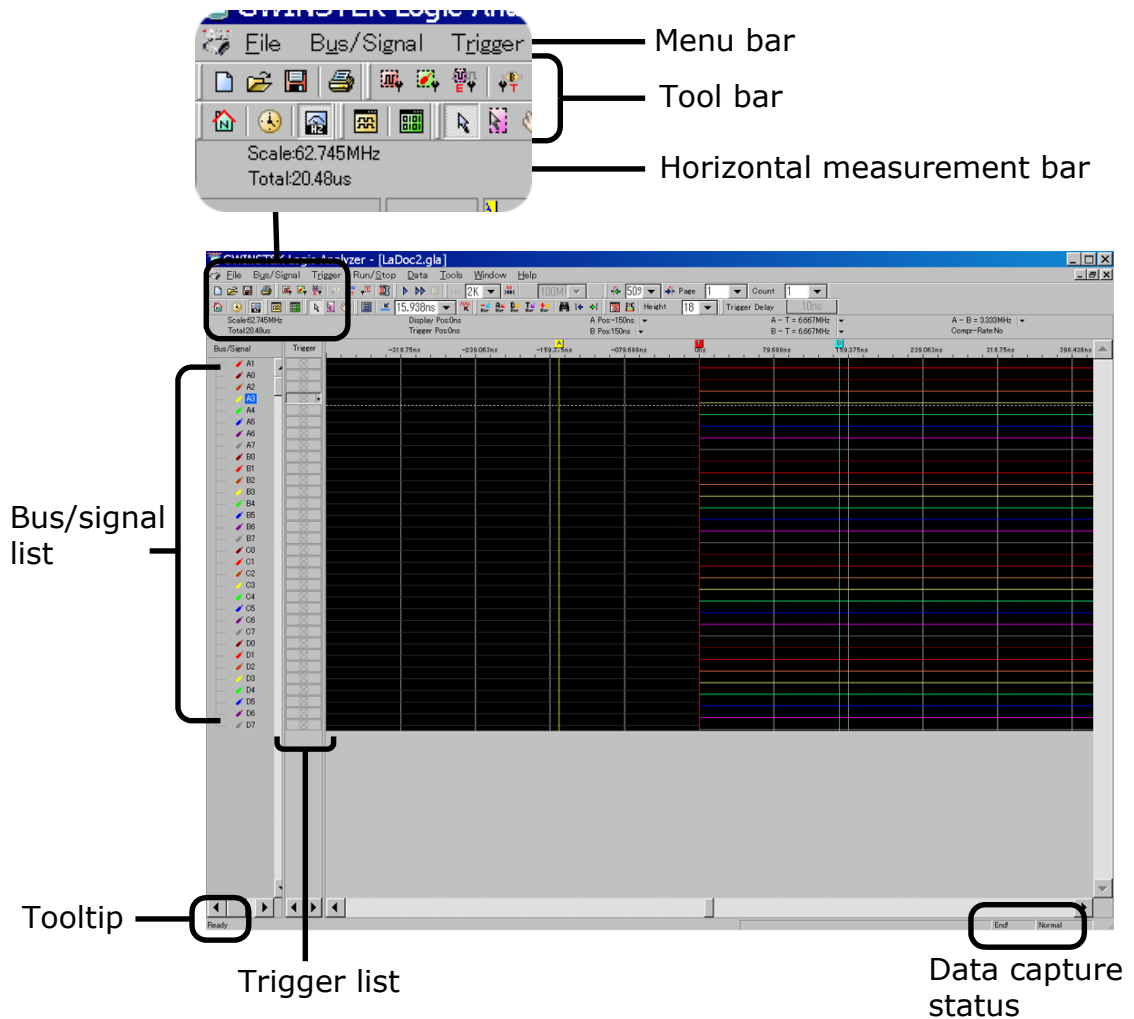

Menu bar















Shortcut	Display	Description
Alt + f	F ile	File operation (page29).
Alt + u	B us/ S ignal	Bus/Signal configuration (page39).
Alt + r	T ri g ger	Trigger configuration (page47).
Alt + s	R un/ S top	Data capturing (page74).



Alt + d	Data	Data operation (page76) and display setup (page62).
Alt + t	Tools	Display setup (page62), Shortcut key setup (page100), I ² C analysis (page90), and RS-232C analysis (page94).
Alt + w	Window	Display configuration (page67) and organizing multiple files (page37).
Alt + h	Help	Help file (page103) and system information (page102).



Tool bar

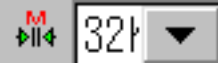

Toolbar collects icons for major operations, sorted in groups.

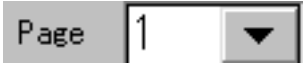

To enable/disable each group, select **T**ools→Customize... from the menu and go to the Toolbar tab. For details, see page63.





Standard group	 Page30 Create a new project file	 Page31 Open a project file	
	 Page32 Save the project file	 Page36 Print out the display	
	Trigger group	 Page40 Configure sampling rate	 Page43 Configure signal/bus
		 Page57 Setup enable function	 Page51 Setup bus trigger properties
 Page48 Setup signal trigger properties		 Page53 Setup general trigger properties	
	 Page42 Enable/disable data compression		
Run/Stop group	 Page74 Single run	 Page74 Continuous run	
	 Page75 Stop running		



Sampling group  Page41 Select sampling memory size  Page41 Select sampling frequency





Trigger content set group  Page56 Set trigger position  Page54 Set trigger page
 Page54 Set trigger count

Display mode group  Page65 Horizontal unit in address  Page65 Horizontal unit in time
 Page65 Horizontal unit in frequency

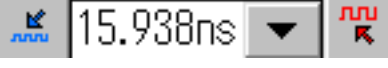
Windows group  Page67 Waveform display mode  Page67 Listing display mode

Mouse pattern group  Normal arrow mode  Page88 Area selection (Enclose) mode
 Page79 Hand mode  Page97 Show waveform statistics

Zoom group  Page88 Show all waveform data  Page89 Limit the waveform display area
 Page87 Zoom in to/out of data

Data group  Page78 Delete data bar  Page79 Move A bar to the center
 Page79 Move B bar to the center  Page79 Move T bar (trigger) to the center

 Page78
Add data bar

 Page83
Search data

 Page81
Go to the previous edge

 Page81
Go to the next edge

Show time/height group

 Page69
Show waveform timing

 Page90
Analyze I²C waveform

 Page94
Analyze RS-232C waveform

 Page66
Change the waveform bar height

Trigger delay group

 Page56
Set and show the amount of trigger delay

Horizontal measurement bar

Displays the horizontal scale and measurement results of the display. For details, see page65.

Horizontal range

Scale:73.737KHz
Total:20.48ms(372.893us)

Scale (upper line) shows the data acquisition clock frequency.

Total (lower line) shows the total length of data acquired by GLA, followed by the length covered by the analysis range bar. For analysis range details, see page89.

Position



Display Pos:0ns
Trigger Pos:0ns
A Pos:-150ns |▼
B Pos:150ns |▼

Display Pos (position) shows the timing of the display center position.

Trigger Pos (position) shows the trigger timing. For details, see page79.

A/B Position shows user-defined bar timings. For details, see page79.

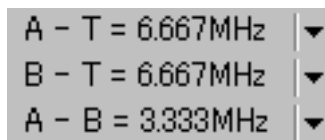
Time/frequency difference



A - T = 6.667MHz |▼
B - T = 6.667MHz |▼
A - B = 3.333MHz |▼

Shows the distance between two bars, whether trigger or user-defined, in time, frequency, or address point. For details, see page65.

Compression **Compr-Rate:0.063**

Shows the data compression ratio when the compression mode is enabled. For details, see page42.

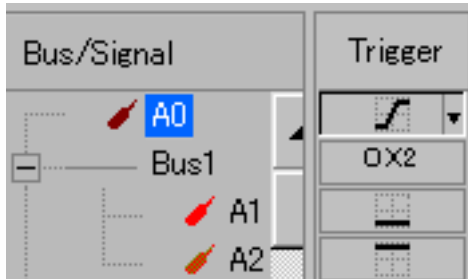
Bus/Signal and Trigger list



Signal and bus names are shown in colored codes, with matching trigger setting on the right side.





Bus/signal setup details → page39.

Trigger setup details → page47.



Operation Shortcuts

This is the collection of all operations available from the menu, icon, or keyboard shortcut. The “Keyboard map” on the Help menu also opens the shortcut list.

File menu



Description	Shortcut	Icon	Menu
Close GLA software.	Alt+F4	—	File→Exit
Create a new file.	Ctrl+N		File→New
Open a file.	Ctrl+O		File→Open
Close the file.	Ctrl+F4	—	File→Close
Save the file.	Ctrl+S		File→Save
Save the file in a different name.	—	—	File→Save As
Save waveform data and setting info into *.txt or *.csv file.	Ctrl+Shift+E	—	File→Export
Save the screen snapshot into *.jpg or *.bmp file.	Ctrl+C	—	File→Capture Window
Select the language.	—	—	File→Language
Prints out the screen snapshot.	Ctrl+P		File→Print
Shows the screen snapshot printout preview.	—	—	File→Print Preview
Opens the standard printer setup window.	—	—	File→Print Setup
Switch between files.	Ctrl+Tab	—	Window→1, 2, ...
Display multiple files at once.	—	—	Window→Cascade, Horizontal, Vertical

Bus/Signal menu



Description	Shortcut	Icon	Menu
Open the Sampling setup dialogue window.	—		Bus/Signal→Sampling Setup
Decrease the sampling rate.	F2	—	—
Increase the sampling rate.	F3	—	—
Open the Channel setup dialogue window.	—		Bus/Signal→Channels Setup
Group signals into bus.	Ctrl+G	—	Bus/Signal→Group into Bus
Ungroup bus into signals.	Ctrl+U	—	Bus/Signal→Ungroup from Bus

Expand the bus.	—	—	Bus/Signal→Expand
Collapse the bus.	—	—	Bus/Signal→Collapse
Automatically adjust the channel row width (only in listing mode)	—	—	Bus/Signal→Format Row→Auto Size
Move the cursor up.	Up	—	Bus/Signal→Format Row→Move Up
Move the cursor down.	Down	—	Bus/Signal→Format Row→Move Down
Hide the signal/bus.	—	—	Bus/Signal→Format Row→Hide
Show all the signal/bus.	—	—	Bus/Signal→Format Row→Show All
Set the signal/bus color.	—	—	Bus/Signal→Format Row→Color
Rename signal or bus.	—	—	Bus/Signal→Rename

Trigger menu



















Description	Shortcut	Icon	Menu
Open the Bus trigger setup dialogue window.	—		Trigger→Bus
Open the Signal trigger setup dialogue window.	—		Trigger→Signal
Open the General trigger properties dialogue window.	—		Trigger→Properties
Change signal trigger condition.	Space	—	Trigger→...

Run/Stop menu



Description	Shortcut	Icon	Menu
Single run.	F5		Run/Stop→Single Run
Continuous run.	F6		Run/Stop→Repetitive Run
Stop running.	F7		Run/Stop→Stop

Data menu



Description	Shortcut	Icon	Menu
Go to the next data page.	PageDown	—	—
Go to the previous data page.	PageUp	—	—
Go to the beginning of data.	Home	—	—
Go to the end of data.	End	—	—
Move the waveform position right.	Right	—	—

Move the waveform position left.	Left	—	—
Add data bar.	Alt+A		Data→Add Bar
Delete data bar.	Alt+B		Data→Delete Bar
Move T bar to the display center.	T, Ctrl+T		Data→GoTo→GoTo Trigger
Move A bar to the display center.	A, Ctrl+A		Data→GoTo→GoTo A Bar
Move B bar to the display center.	B, Ctrl+B		Data→GoTo→GoTo B Bar
Move any bar (T, A, B, Ds, Dp, user defined bar) to the display center.	—	—	Data→GoTo→GoTo More
Move to the previous edge.	F11		Data→Before
Move to the next edge.	F12		Data→After
Move the display sideways (use the Hand pointer).	H		Data→Hand
Select the zoom area (use the Enclose pointer)	E		Data→Enclose
Use the normal pointer.	Esc		Data→Normal
Search data.	Ctrl+F		Data→Find Data Value
Zoom in.	F9		Data→Zoom In
Zoom out.	F8		Data→Zoom Out
Undo the last zoom.	Ctrl+Z		Data→Undo Last Zoom
Show all data.	F10		Data→Show All Data
Adjust the display range to analysis bar.	—		—
Select the data analysis range.	—	—	Data→Select Analytic Range
Show waveform analysis result.	—		—
Show waveform data in binary.	—	—	Data→Show As→Binary
Show waveform data in decimal.	—	—	Data→Show As→Decimal
Show waveform data in hexadecimal.	—	—	Data→Show As→Hexadecimal
Show waveform in square form.	—	—	Data→Wave Mode→Square Waveform
Show waveform in sawtooth form.	—	—	Data→Wave Mode→Sawtooth Waveform
Activate data compression.	—		—

Tools menu

Description	Shortcut	Icon	Menu
Open the display customize dialogue window.	—	—	<u>T</u> ools→Customize
Open the I ² C analysis dialogue window.	—		<u>T</u> ools→Analy IIC Wave
Open the RS-232 analysis dialogue window.	—		<u>T</u> ools→Analy UART Wave
Show the waveform timing.	—		<u>T</u> ools→Show time of waveform

Window menu

Description	Shortcut	Icon	Menu
Open the display customize dialogue window.	—	—	<u>T</u> ools→Customize
Show the waveform view.	—		<u>W</u> indow→Waveform Display
Show the listing view.	—		<u>W</u> indow→Listing Display
Show the waveform timing.	—		<u>W</u> indow→Show time of waveform
Switch between files.	Ctrl+Tab	—	<u>W</u> indow→1, 2, ...
Display multiple files at once.	—	—	<u>W</u> indow→Cascade, Horizontal, Vertical

Help menu

Description	Shortcut	Icon	Menu
Open the Help file.	F1	—	<u>H</u> elp→GWInstek Logic Analyzer
Open the keyboard shortcut list.	—	—	<u>H</u> elp→Keyboard Map
Send a bug reporting email.	—	—	<u>H</u> elp→Report a Problem
Show the software version.	—	—	<u>H</u> elp→About GWInstek Logic Analyzer

Installation

This chapter describes software installation, activation, and functionality check. Follow these instructions to properly install GLA series.

Software installation	PC requirement	21
	Setup activation	22
	License agreement	22
	User information	23
	Setup type	23
	Custom setup	24
	PC reboot	24
	Driver installation	24
	Uninstall, repair, modification	25

Power Up	Power Up	26
	Demonstration mode	27

Functionality check	Hardware connection	28
	Signal capturing	28

Software Installation

PC requirement

The readme.txt file in the CD-ROM also contains this information.

OS	Windows XP Windows 7 Windows Vista
CPU	Windows XP: 300MHz minimum Windows Vista (Basic): 800MHz Windows 7 (32, 64 bit), Vista (all other versions): 1GHz minimum
RAM	Windows XP: 256MB minimum Windows Vista (Basic): 512MB Windows 7(32 bit), Vista (all other versions): 1GB Windows 7(64 bit): 2GB
Hard disc	Windows XP: 100MB minimum Windows Vista(all versions): 15GB free Windows 7(32 bit):16GB Windows 7(64 bit):20GB
DirectX 9 (Windows 7 and Vista only)	Windows Vista(Basic): 32 MB of video memory with DirectX 9-class graphics card. Windows Vista (all other versions): 128MB of video memory. Windows (7 & Vista):DirectX 9.0C Redistributable for software Developers. It can be downloaded from the Microsoft website: http://www.microsoft.com/en-us/download/details.aspx?id=2730
USB	1 USB host connector, 2.0 compatible

Installation procedure

Setup activation Insert the software CD-ROM into the PC. If the below Setup screen does not appear, double-click the Setup.exe file.

Click the INSTALL button.



License agreement

Read the license term and select acept, click Next.

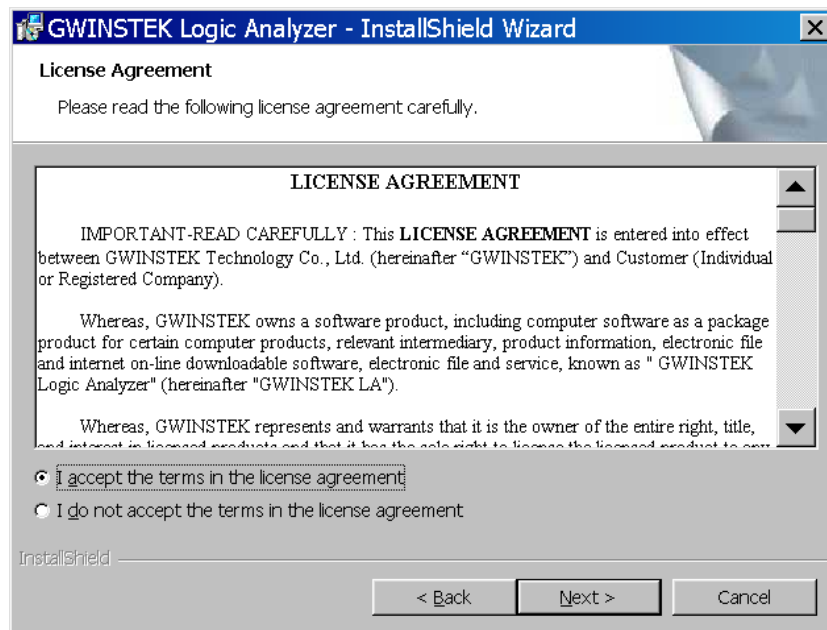

User information Enter your user name and organization. Set the range of user access: All users or the user currently logged in.

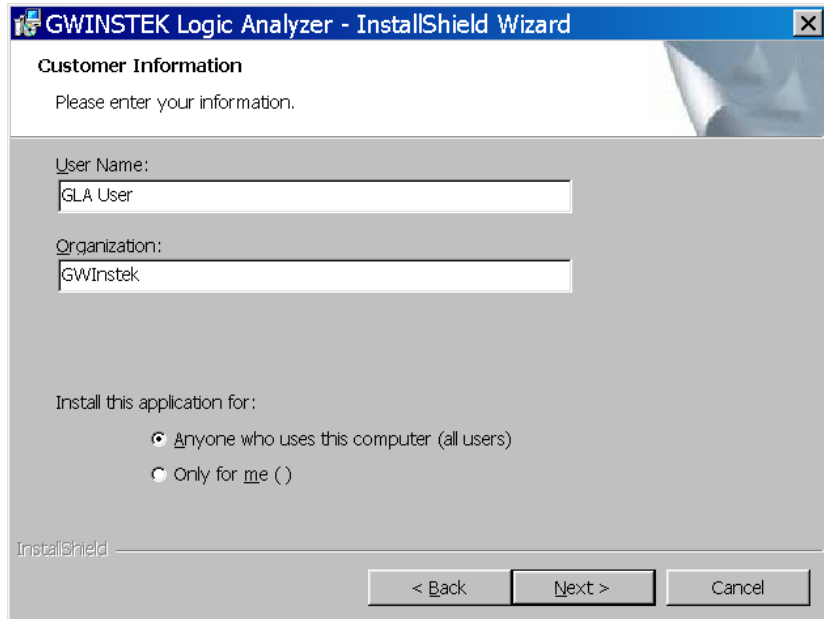

Setup type Select the setup type.

Complete setup: All features will be installed. The program directory is automatically set.

Custom setup: Installed features and program directory are set by the user. See the next page.

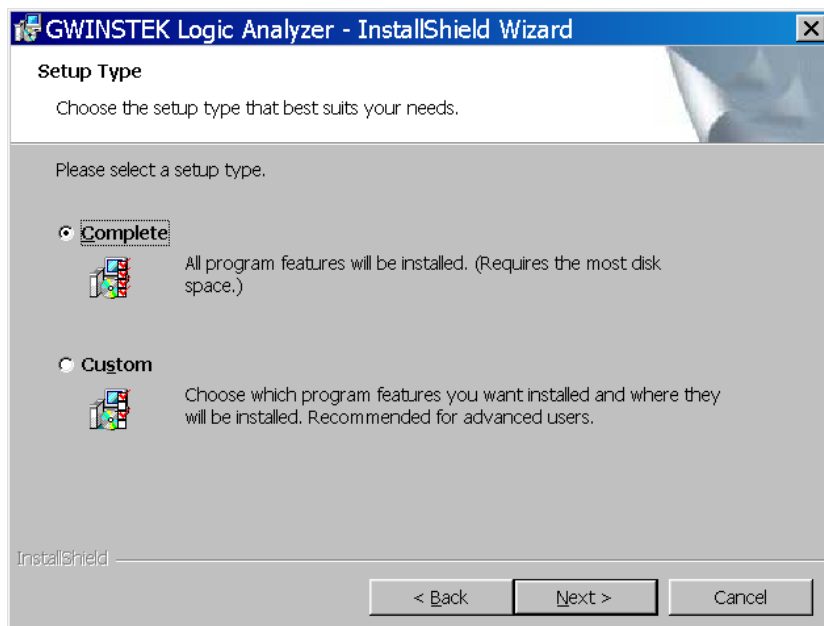

Custom setup

The custom setup option allows users to select the program features and directory. Installed features can be modified later (page25).

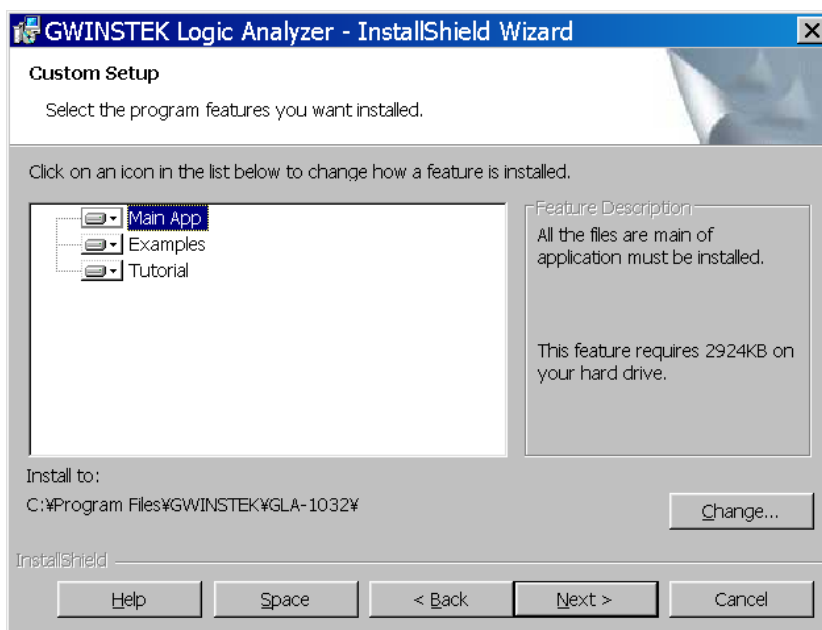

PC reboot

Reboot the PC when the installation is completed.

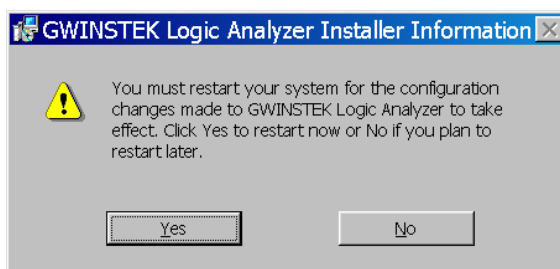

Driver installation

By default the driver is installed together with the main program. In case the PC requires a separate software driver installation, select USB_LA.inf file in the software package.

Uninstall, repair, modification

This page assumes the GLA software is already installed.

Uninstall

Select UnInstall from the PC startup menu,



Or select Remove in the Program Maintenance mode (see below).

Modify/repair

Insert the software CD-ROM and activate Setup.exe. The Program Maintenance menu appears.

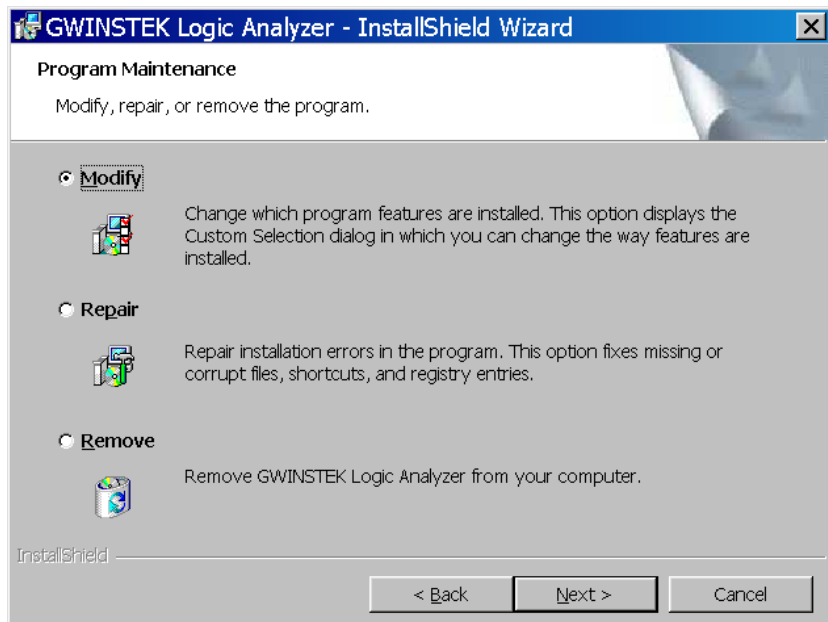

Modify option: Lets the user re-select the installed features.

Repair option: Checks the program status and fixes any broken files.

Remove option: Uninstalls the software.

Power Up

This section assumes the software is already installed.

Hardware connection

Connect GLA and the PC via the USB cable. Press the GLA power switch and make sure the power LED turns On.

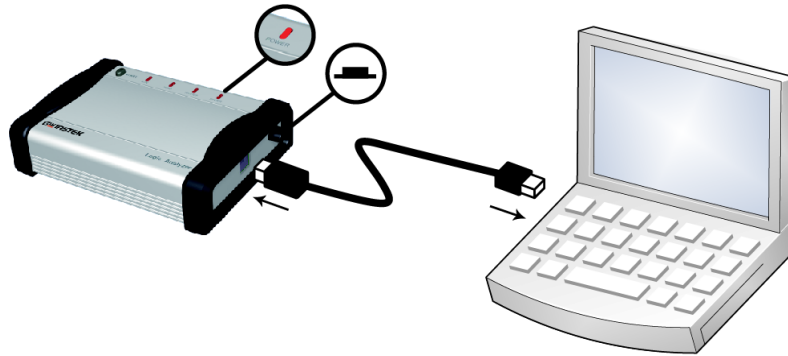

Software activation



1. Double-click the desktop GLA icon  or activate the GLA from the program startup menu.



2. If the hardware connection error message appears, try the following.
 - * Reset the GLA USB connection and try again.
 - * Make sure GLA and PC are connected by a single USB cable (Do not use USB extension cable).

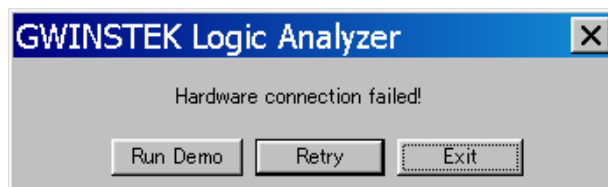

3. If there is already a setup file (*.gla) being saved, the software asks whether to open it.

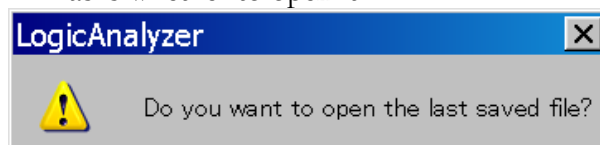

4. The display appears.

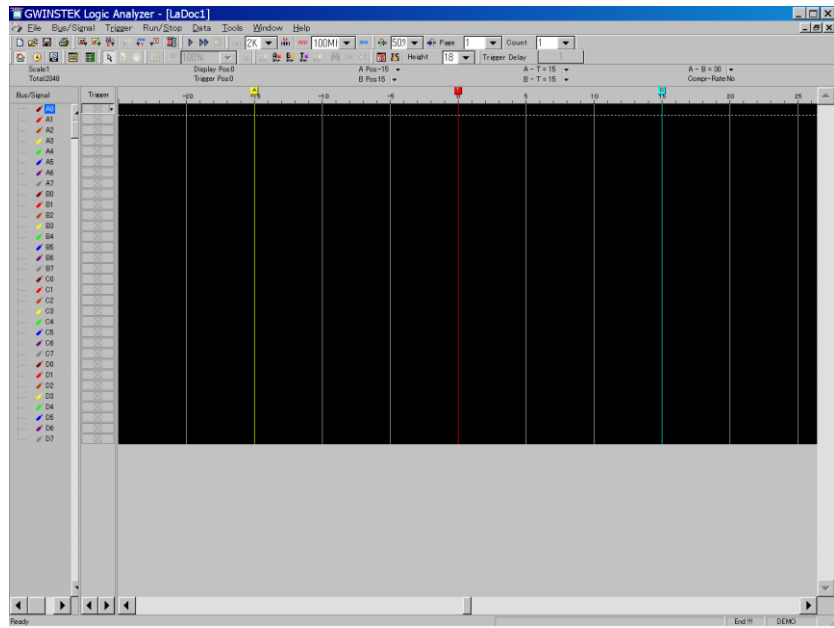

Demonstration mode

You can still run the software without the GLA hardware. When the Hardware connection failure message appears, click Run Demo button.

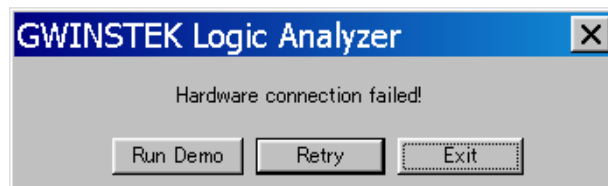

Most of the software features are available, except for signal capturing. You can even recall the old waveform data to be displayed.

Functionality Check

Hardware connection Activate GLA (page26) and connect the signal source to one of the input terminals.

Signal capturing Do one of the following actions to capture the signal.

- Press the Start button on GLA
- Click the Run  button on the display
- Press F5 (shortcut for the single run)
- Select Single Run from the Run/Stop menu

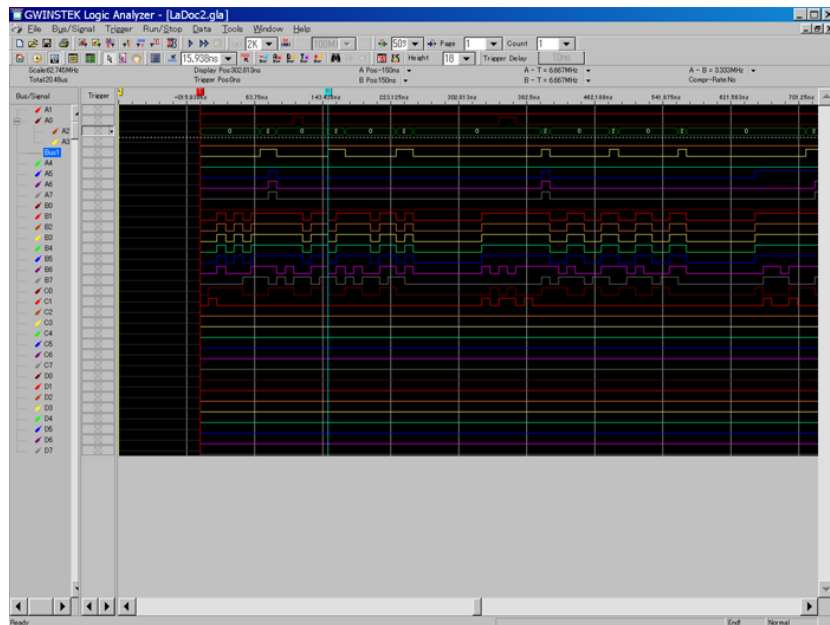

Make sure the signals appear on the display, at the corresponding terminals.

File Operation

Open/Close	Open GLA software	30
	Close GLA software	30
	Create a file	30
	Open a file	31
	Close the file	31
Save	Save the project file	32
	Save the project file in a different name	32
	Export the data	32
	Save the display image	34
Printout	Print	36
	Print Preview	36
	Printer Setup	36
Handling multiple files	Switch between files	37
	Display multiple files	37

Open/Close

Open GLA software

Activates GLA software.

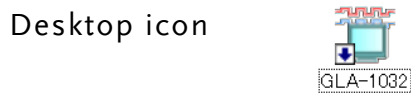

Note If there is already a setup file (*.gla) being saved, the software asks whether to open it or not.

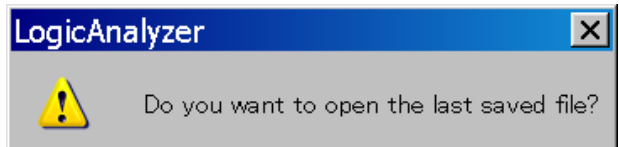

Close GLA software

Closes GLA software.



Shortcut key Alt+F4

Create a file

Creates a new project file.



Shortcut key Ctrl+N



File format LaDocx.gla (x stands for integers: 1, 2, 3...)

Open a file

Opens an existing setup file.

Menu

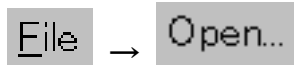

Shortcut key

Ctrl+O

Icon



File format

*.gla

File properties

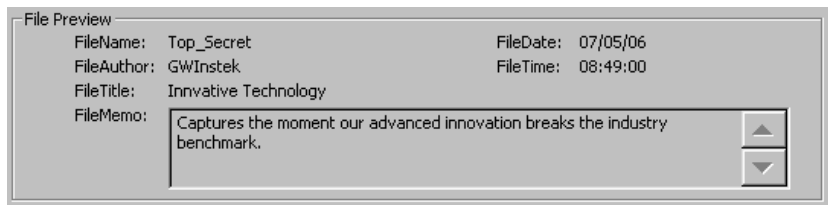

The File open dialogue windows shows the file properties of the pointed *.gla file.

File name, project, author, title, and note can be set at Save As dialogue (page32).

Close the file

Closes the active project file.

Menu

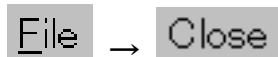



Shortcut key

Ctrl+F4

Save

Save the project file

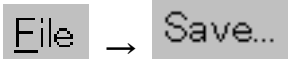
Overwrites and saves the active Logic Analyzer project file. If the file has never been saved before, the Save As window appears.

Menu	
Shortcut key	Ctrl+S
Icon	

Save the project file in a different name

Saves the active Logic Analyzer file in a different name, or in a different directory.

Menu	
File format	*.gla
Dialogue window	The Save As dialogue window includes File property corner where you can fill in the project name, project staff name, and additional note. These information can be viewed when opening the file,

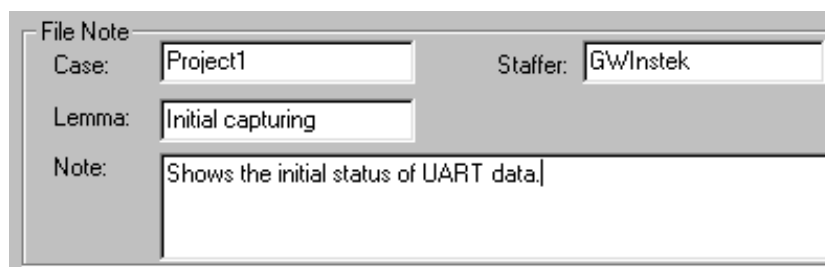

Export the data

Saves waveform data and setup information into *.txt or *.csv format.

Menu	
------	---

Shortcut key Ctrl+Shift+E

Dialogue window

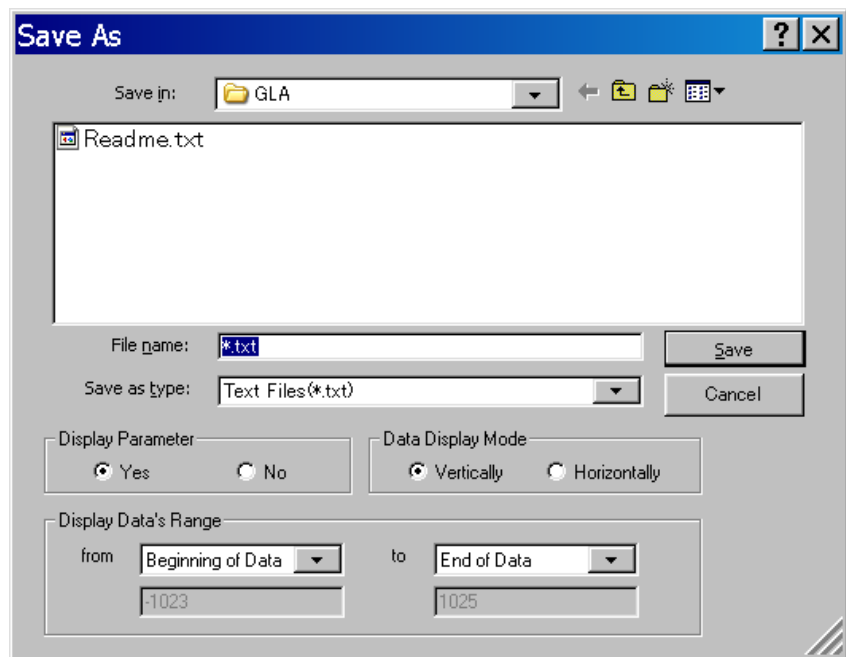

File Type	*.txt	Plain Text format.
	*.csv	Comma-Separated Values format. Each waveform data is listed in tables as separate entities.

Display parameter	The setup information includes the following:	
	<ul style="list-style-type: none"> • File name, size, date • Sampling mode, sampling frequency • Ram size, data compression ratio • The number of Bus/channel • Trigger level, count, page, Enable setting • Bar position 	
	Yes	The file contains system measurement setup information as well as waveform data.
	No	The file contains only the waveform data.

Data display mode	Vertical	Sets the waveform data format into: Horizontal direction – channel Vertical direction – waveform data
	Horizontal	Sets the waveform data format into: Horizontal direction – waveform data Vertical direction – channel

Display data range

Specifies the range of the saved data. The gray area shows the position of the selected item.

- From:/ To:
- Beginning of data
 - End of data
 - Trigger bar
 - A bar
 - B bar
 - User defined

Save the display image

Saves the whole or part of the PC screen snapshot image, in Jpeg (*.jpg) or Bitmap (*.bmp) format.

Menu

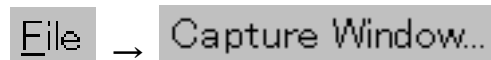

Shortcut key

Ctrl+C

Dialogue window

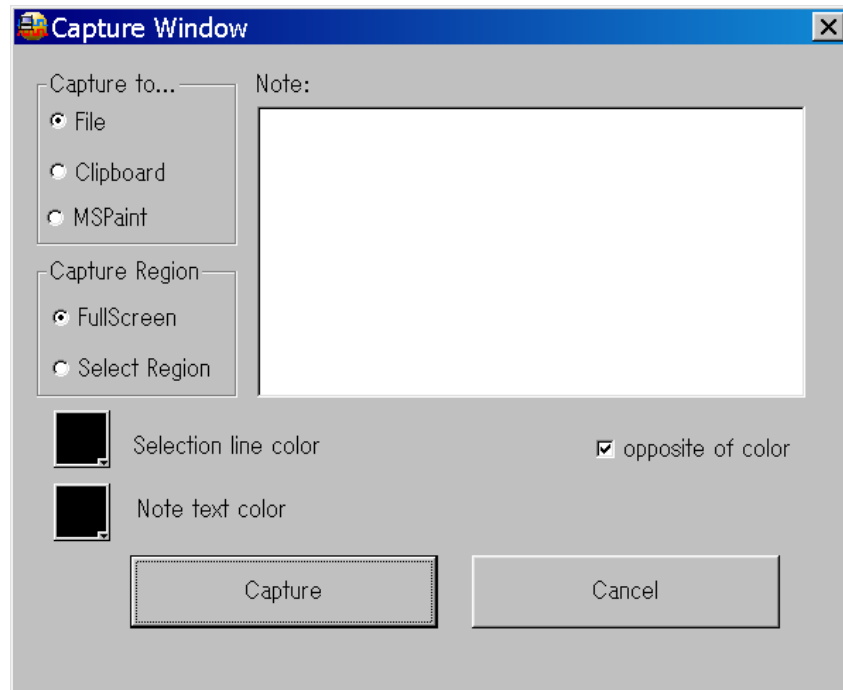

Note

Note: Adds the entered comment to the captured snapshot.

	<p>Note color</p> 	<p>Clicking the icon opens the chart for selecting the note text color. Default: black.</p>
<p>Capture to...</p>	<p>File</p> <p>Clipboard</p> <p>MSPaint</p>	<p>The captured snapshot is saved to an external file. File format: *.jpg, *.bmp</p> <p>The captured snapshot is saved to the Windows Clipboard, to be pasted into other applications.</p> <p>The captured snapshot is opened in Microsoft Paint, in *.bmp format.</p>
<p>Capture region</p>	<p>FullScreen</p> <p>Select Region</p>	<p>The full screen is captured (same as pressing the PrtSc key).</p> <p>A cropping tool appears, allowing capture of selected area.</p>

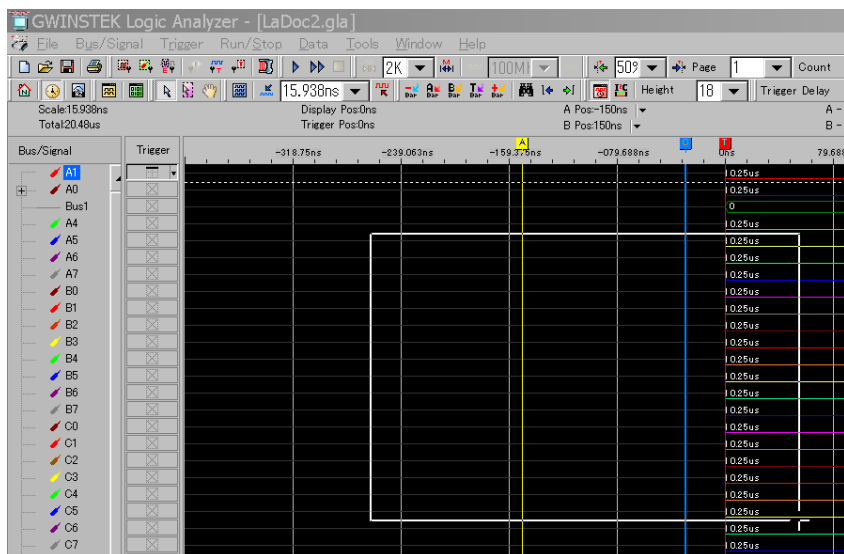

Selection line



Clicking the icon opens the crop tool color chart. Checking the opposite of color radio opposite of color selects the opposite of the specified color, as in the above figure (white line).

Printout

Print

Prints out the waveform image.

Menu  → 

Shortcut key Ctrl+P

Icon 

Print Preview

Shows waveform image printout preview. The file name and the date are also printed out.

Menu  → 

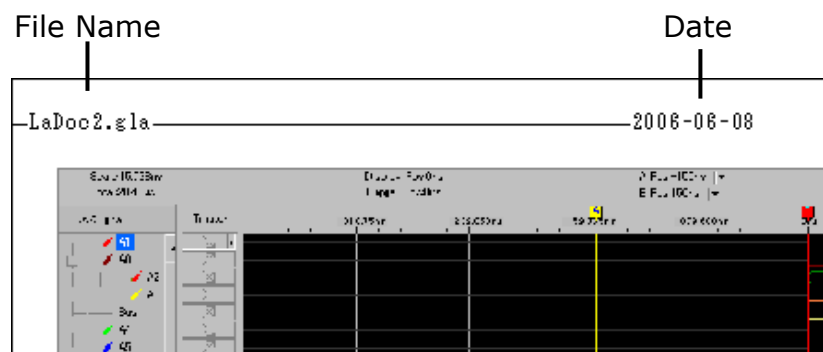

Printer Setup

Opens the standard printer setup dialog window.

Menu  → 

Handling Multiple Files

This section assumes more than one files are already opened.

Switch between files

Menu Click the target file accessible from the Windows menu.

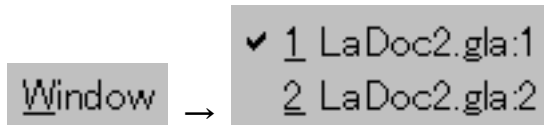

Shortcut key Ctrl+Tab

Display multiple files

Menu

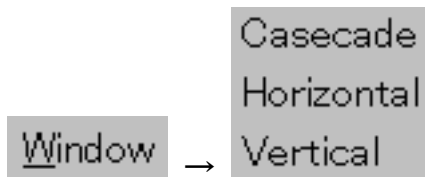

Cascade format

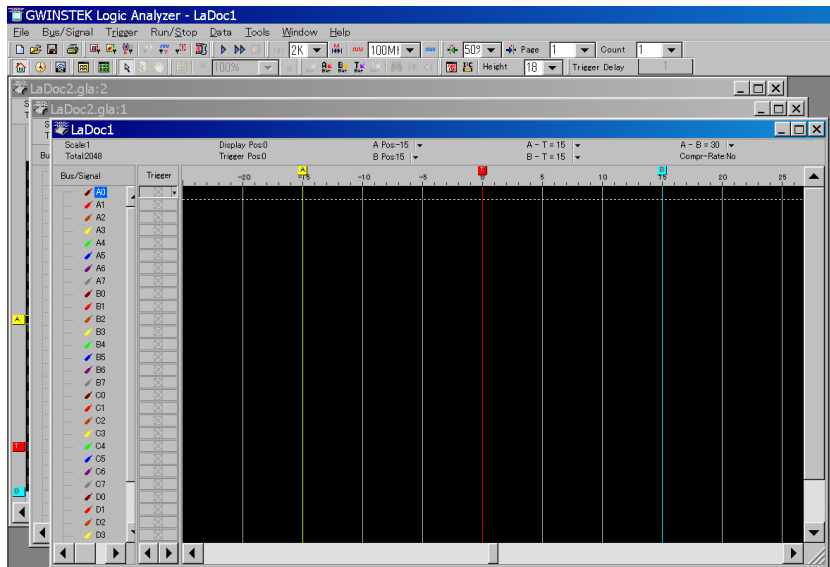

Horizontal format

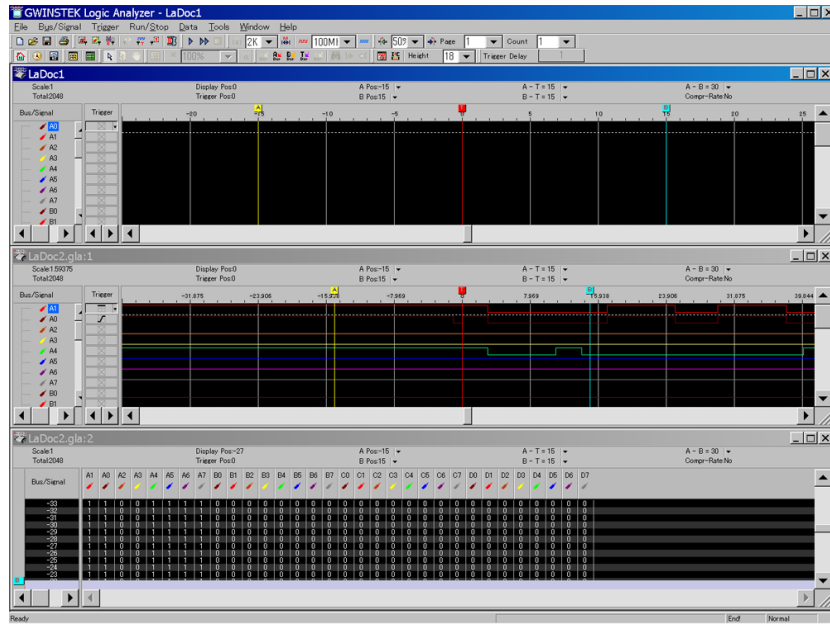

Vertical format

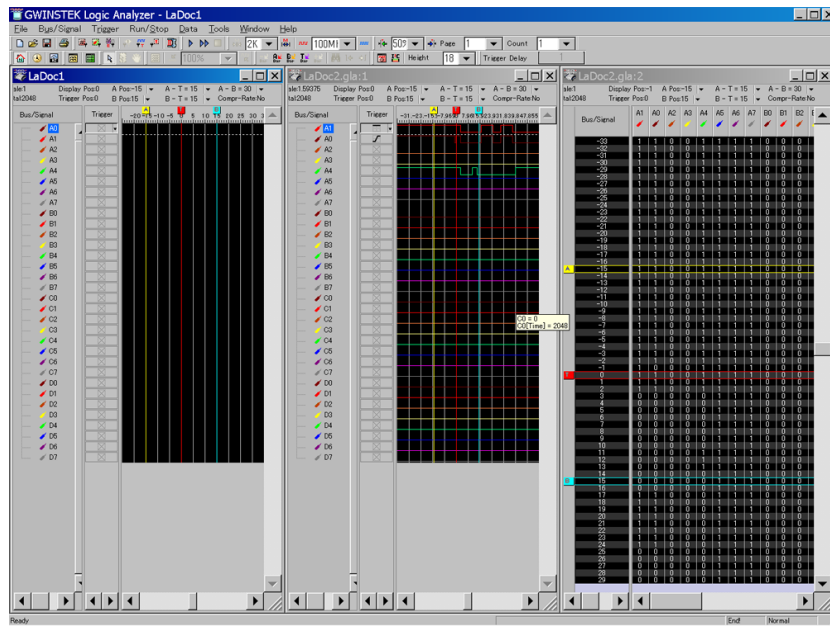

Bus/Signal Setup

Sampling /	Clock source	41
Compression setup	Sampling RAM size	41
	Compression mode	42
<hr/>		
Bus/Signal setup	Add/Delete.....	43
	Group/Ungroup	44
	Rename	45
	Hide/Show signals and buses	46

Sampling/Compression Setup

GLA can setup the clock source, sampling frequency, memory size, and data compression.

Menu **Bus/Signal** →  **Sampling Setup ...**

Icon 

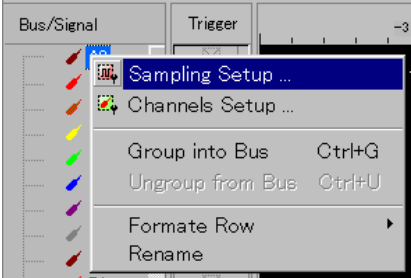
Context menu  Right-click on the Bus/Signal list, then select Sampling Setup.

Dialogue Window

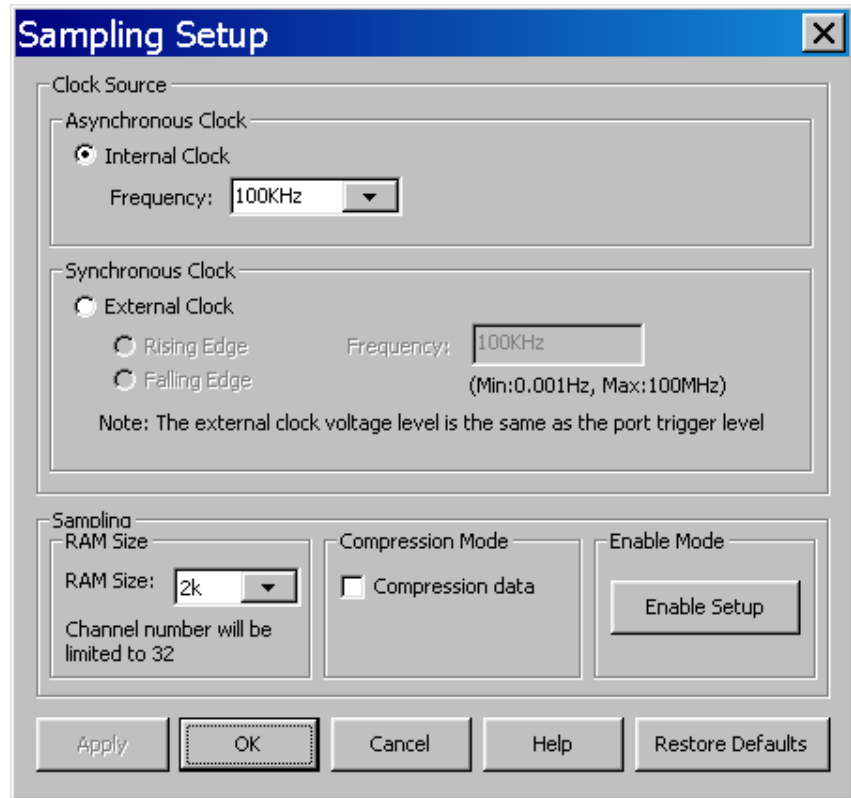

Clock source

Internal (asynchronous) clock

Toolbar icon 

Frequency is selectable from 18 frequency range.

Range: 100Hz ~ 200MHz.

External (synchronous) clock

The clock signal needs to be connected to the CLK input terminal.

Range: 0.001Hz ~ 100MHz.

Rising edge or falling edge is selectable.

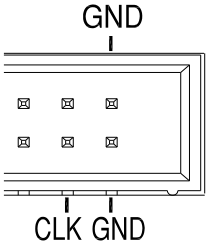

 **Sampling frequency**

To ensure accurate measurement, choose a sampling frequency at least four times that of the target signal.

Sampling RAM size

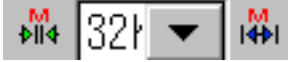
Toolbar icon 

Select the amount of waveform memory GLA captures in a single run. Note that large memory size slows down display update rate.

RAM size	Channel	Compression	Enable mode
2k bits	16/32	Yes	Yes
16k bits	16/32	Yes	Yes
32k bits	16/32	Yes	Yes
64k bits	16/32	Yes	Yes
128k bits	16/32	Yes	Yes
256k bits (GLA-1016/1032)	16 only	No	No
256k bits (GLA-1132)	32	Yes	Yes
512k bits (GLA-1132 only)	32	Yes	Yes
1M bits (GLA-1132 only)	32	Yes	Yes
2M bits (GLA-1132 only)	16	No	No



limitation

Using large amount of memory (256k bits for GLA-1016/1032, 2M bits for GLA-1132) imposes the following restrictions.

- Only 16 channels, A0 ~ B7, available
- Compression not available
- Enable mode not available

Compression mode

Toolbar Icon



When selected, GLA uses a lossless compression technique to expand the signal record length. The compression ratio is maximum 255, automatically adjusted.

The maximum record length per channel is:

GLA-1016, 1032: 128kbit x 255 = 32Mbit

GLA-1132: 1024kbit x 255 = 256Mbit

The actual compression rate is displayed on the upper-right side of the display (In the below case, 1.391).

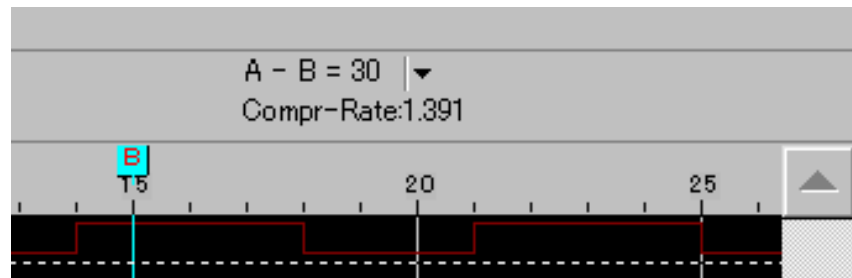

Compression limitation

Compression mode imposes the following restrictions.

- For 32 channel model, channel number is reduced to 24, A0 ~ C7, regardless of the memory size.
- Enable mode becomes unavailable.

Enable mode

Opens the Enable function setup dialogue window. For details, see the Trigger setup chapter, page57.

When completed...

Press Apply/OK/Cancel button to save or cancel the setting.

Restore Defaults button setting: Internal clock, 100MHz/ 2k RAM size/ No compression.

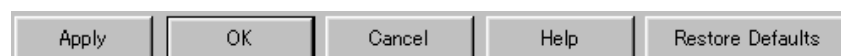

Signal/Bus setup

Add/Delete

Menu Bus/Signal → Channels Setup ...

Icon

Context menu Right-click on the Bus/Signal list and select Channel Setup.

Dialogue window

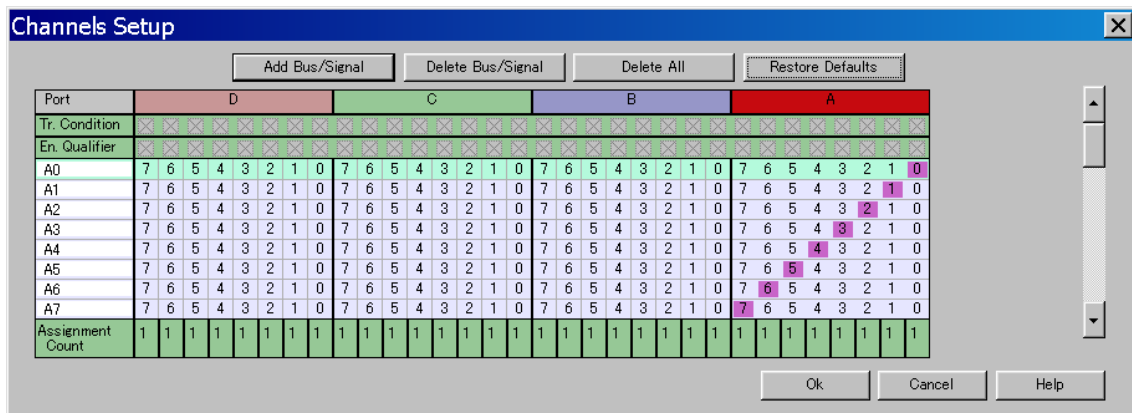

Use the right side bar to scroll up or down. Port C and D are not available in GLA-1016.

Add Bus/Signal



Click the Add Bus/Signal button. A new signal named Newx (x stands for 0, 1, 2...) appears on top of A0.

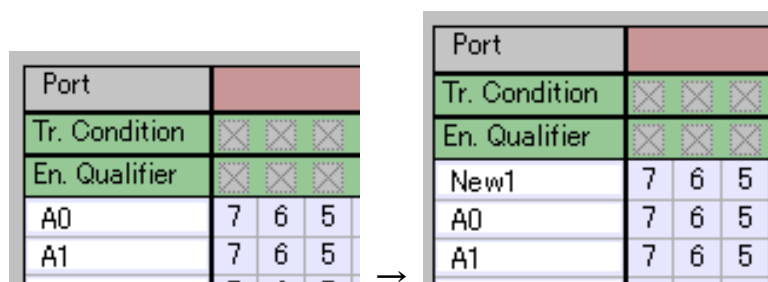

Delete Select the target signal/bus and click either:

Bus/Signal Delete Bus/Signal – the selected single bus or signal. Or
 Delete All – all buses and signals.



Restore Default Restores the default status (all channels are active).

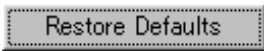

Group/Ungroup

Group signals into bus, or ungroup a bus into signals.

Menu Bus/Signal → Group into Bus (group)
 Bus/Signal → Ungroup from Bus (ungroup)

Shortcut keys Ctrl+G (group)
 Ctrl+U (ungroup)

Method1 Open the Channels setup dialogue window, select the grouped signals and press Ok. The following example shows that ChannelD0 ~ D3 are grouped into D0 bus.

Channel Setup dialogue

Port	D							
Tr. Condition	X	X	X	X	X	X	X	X
En. Qualifier	X	X	X	X	X	X	X	X
D0	7	6	5	4	3	2	1	0
D1	7	6	5	4	3	2	1	0

Result

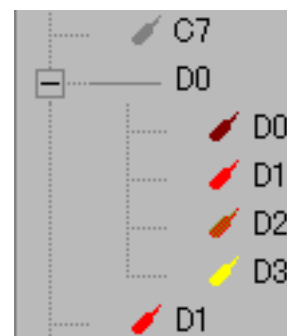

Method2 In the main display, select the range of signals by pressing the Shift key and clicking the signal names. Then choose Bus/Signal → Group. A bus named Busx (x stands for 1, 2, 3...) is formed. To ungroup the bus, choose Ungroup from Bus menu.

Picking up the signal (D0 ~ D3)

Result

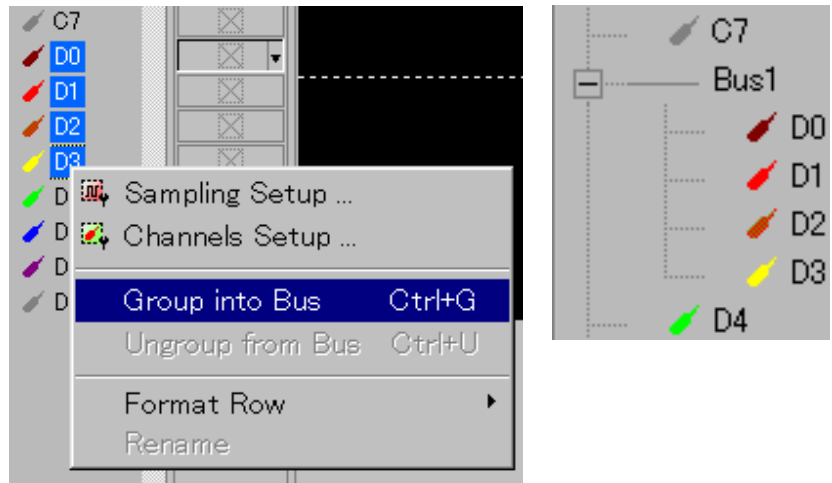

Rename

Method1

Click the target signal in the display.



Click again on the target signal, OR

Select Rename from the menu,

Bus/Signal → **Rename** OR

Right-click and select Rename from the context menu.

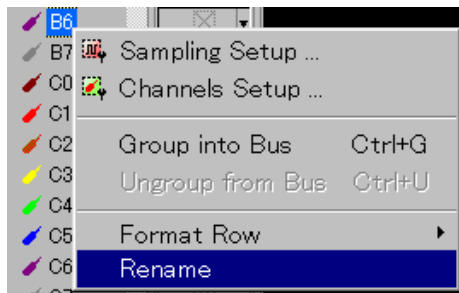

Type in the new name and press Enter key to confirm.



Method 2

In the Channels setup dialogue window (page43), Click the target signal name, and type in the new name.

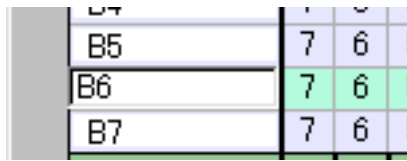

Hide/Show signals and buses

This function hides signals and buses from display but do not delete them. Show All function can reveal them. For deleting signals and buses, see page43.

Menu

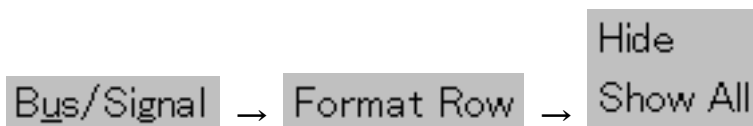

Context menu

Right-click on Bus/Signal list and select Format Row menu.

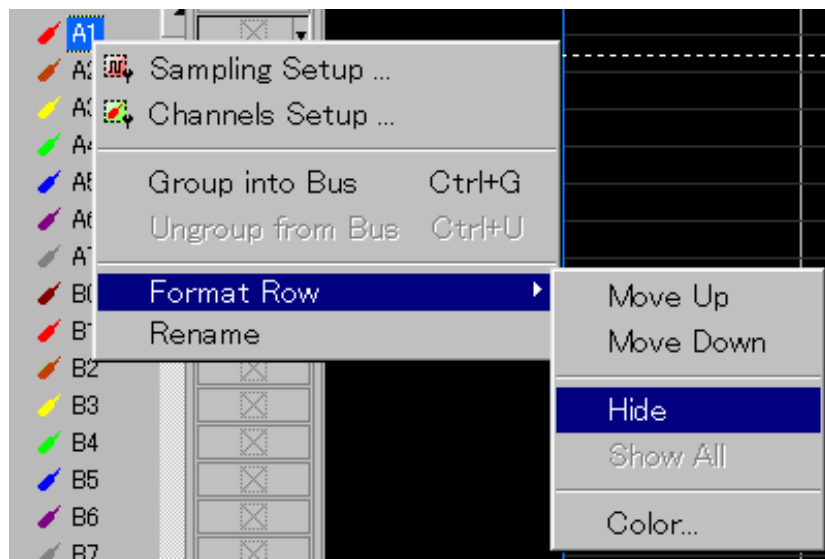

Example

Before hiding A1

After hiding A1

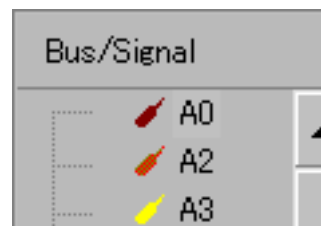
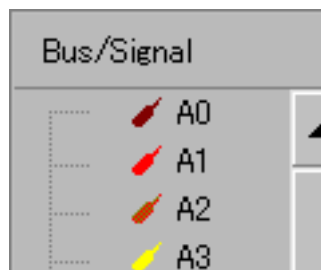







Trigger Setup

This chapter describes how to configure the triggering conditions.

Signal triggering condition setup	Set the condition individually.....	48
	Set conditions for multiple channels	49
	Reset all trigger conditions	50
Bus triggering condition setup	Operator (Trigger condition)	52
	Reset all trigger conditions	52
General triggering properties setup	Trigger level	53
	Trigger Count	54
	Trigger Page	54
	Trigger position.....	56
	Trigger delay	56
Enable Trigger function setup	Enable Qualifier	58
	Enable Period.....	59
	Delay Start Point.....	59
Trigger output signal	Trigger Output Signal.....	61

Signal Triggering Condition Setup

Trigger condition	<p>Don't care</p> 	<p>GLA captures all data regardless of its condition.</p>
	<p>High</p> 	<p>GLA triggers capturing the signal when the level is high.</p>
	<p>Low</p> 	<p>GLA triggers capturing the signal when the level is low.</p>
	<p>Rising edge</p> 	<p>GLA triggers capturing the signal when the level is changing from low to high.</p>
	<p>Falling edge</p> 	<p>GLA triggers capturing the signal when the level is changing from high to low.</p>
	<p>Either edge</p> 	<p>GLA triggers capturing the signal when the level is changing from one level to another, low to high or high to low.</p>

Set the condition individually The following method sets the trigger condition for each channel individually.

Method1

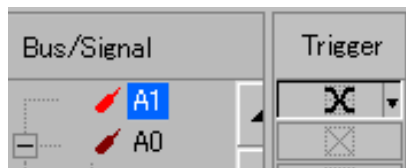

Select the target signal (A1 in this case) and:

Click the Trigger condition icon repeatedly

OR

Press the space bar repeatedly.

Method2

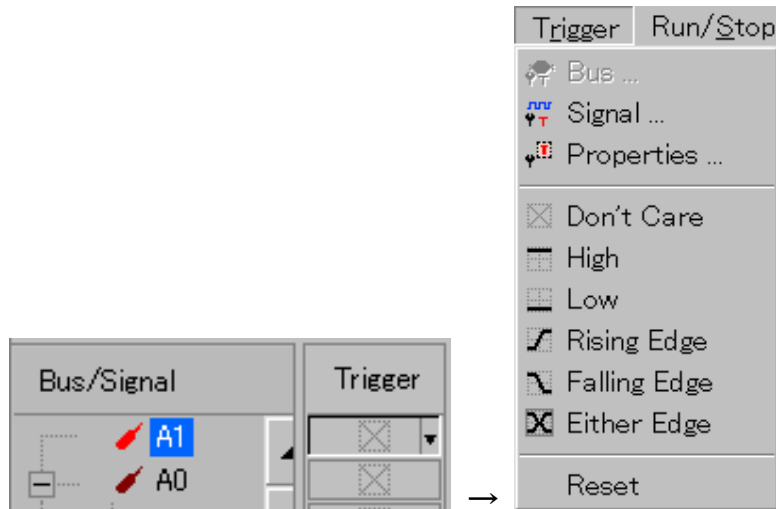

Select the target signal (A1 in this case) and click the Trigger list, then select the trigger condition from the Trigger menu.

Set conditions for multiple channels

This method sets the trigger condition for multiple channels at once.

Open the Trigger dialogue window.

Menu

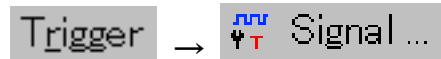

Icon



Context menu

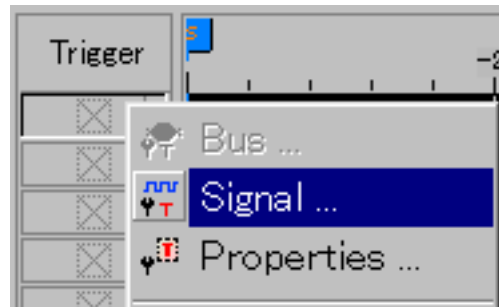

Right-click on the Trigger list area and select Signal.

Dialogue window

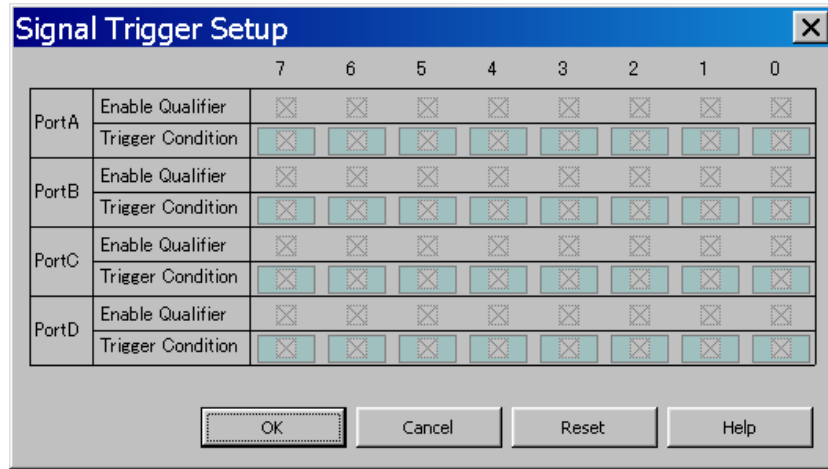

Click the the target signal repeatedly and select the appropriate trigger condition.

Reset all trigger conditions

Resets all the channel trigger conditions to Don't care (default) state.

Choose Reset from the Trigger menu

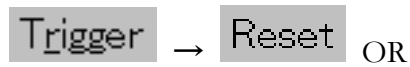

Click the Reset button in Signal Trigger Setup dialogue.

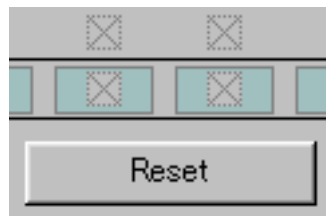

Bus Triggering Condition Setup

Menu

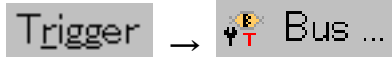

Icon



Context menu



Right-click on the Trigger list for the target bus (Bus1 in this case) and select Bus menu.

Dialogue window

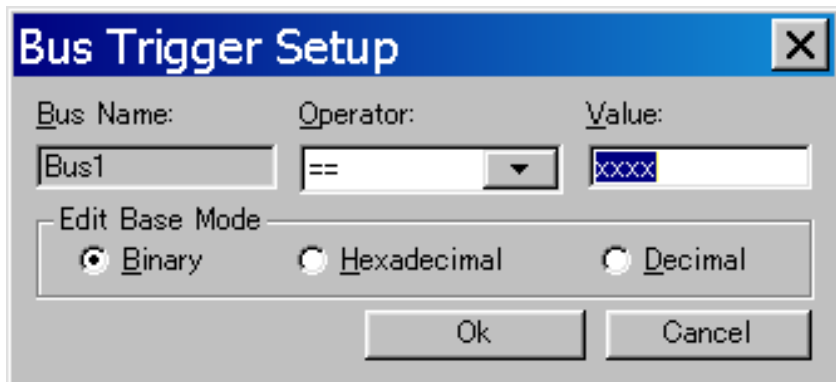

Operator (Trigger condition) ==

GLA triggers capturing data when the entered value matches the real data.

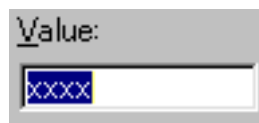

Binary

Sets the value in binary mode: 0, 1, x (don't care).

Hexadecimal

Sets the value in Hexadecimal value: 0 ~ F.

Decimal

Sets the value in Decimal value: 0 ~ 9.

Don't care

GLA triggers capturing data regardless of the value.

Reset all trigger conditions

Resets all the bus trigger conditions to Don't care (default) state. Choose Reset from the Trigger menu.

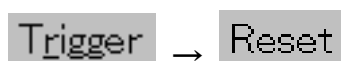

General Triggering Properties Setup

This function sets the triggering properties applicable to all channels and buses.

Menu **Trigger** →  **Properties ...**

Icon 

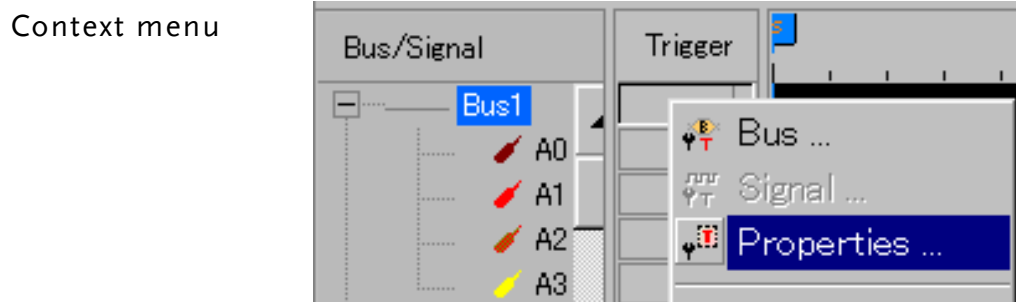

Right-click on the Trigger list and select Properties menu.

Trigger Properties
Dialogue window

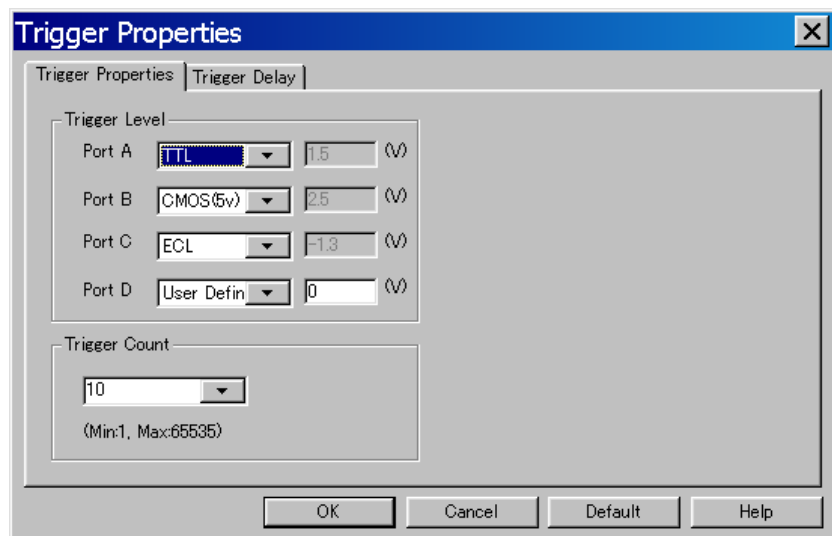

Port C and Port D are not available for GLA-1016.

Trigger level

Set the triggering level for each port, A ~ D.

Type	Level
TTL	1.5V
CMOS (5V)	5V
CMOS (3.3V)	3.3V
ECL	-1.3V
User Defined	-6 ~ 6V

Trigger Count

Toolbar icon

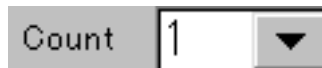

Sets the number of times GLA skips triggering condition. Setting is available in pull-down (1, 2, 3, 4, 5, 10, 15, 20) or direct entering.

Example



GLA starts capturing data at the first triggering condition (default).



GLA starts capturing data at the fifth triggering condition.



You can directly type in any number, up to 65,535.

Trigger Delay
dialogue window

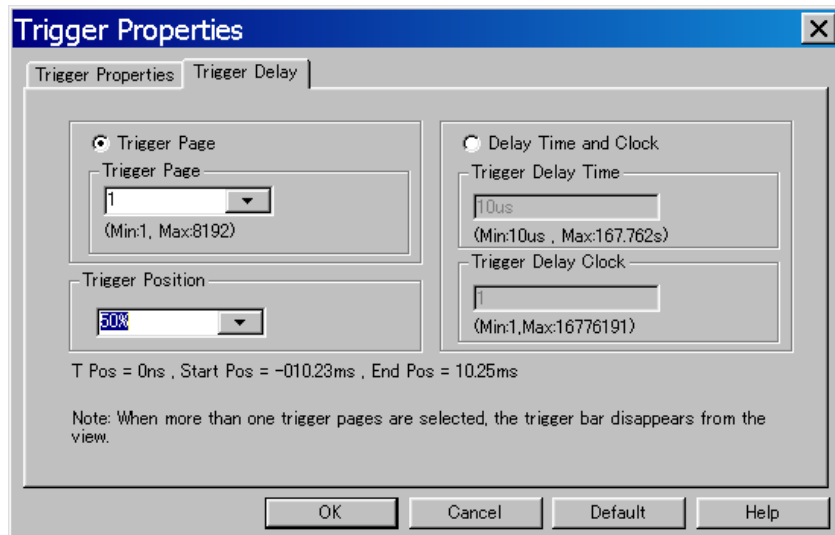

Select the Trigger Delay tab in the Trigger Properties dialogue.

Trigger Page

Toolbar icon

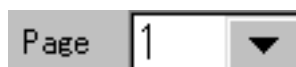

This function sets the length of skipped waveform (in data memory blocks) after the triggering condition. Setting is available in pull-down (1, 2, 3, 4, 5, 10, 15) or direct entering.

Waveform data in a single page = Sampling RAM size
(for RAM size setting, see page41)

Maximum trigger page for different RAM size

RAM size	GLA-1016	GLA-1032	GLA-1132
2Kbit	8192	8192	8192
16Kbit	1024	1024	1024
32Kbit	512	512	512

64Kbit	256	256	256
128Kbit	128	128	128
256Kbit	128	128	64
512Kbit	N/A	N/A	32
1Mbit	N/A	N/A	16
2Mbit	N/A	N/A	16

Trigger Page Example

GLA captures the data at the first triggering condition (default).

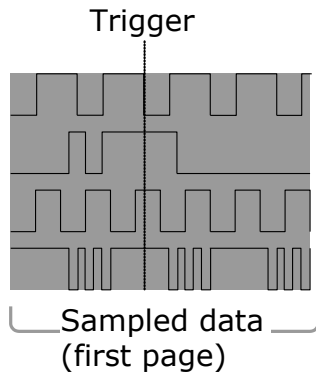

Sampled data = the first memory block

GLA captures the data at the third memory block after triggering condition occurs.

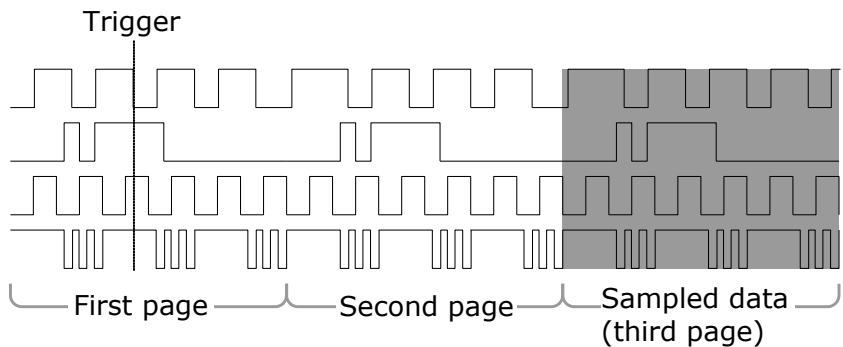

Sampled data = the third memory block

(Min:1, Max:8192)

You can directly type in any number, up to the value shown below.

Trigger page /

delay

Trigger page disables Trigger delay/clock function (page56), vice versa.

Trigger position

Toolbar icon

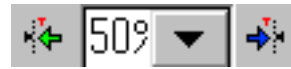

Sets the amount of pre-triggering data that GLA captures, selectable from the pull-down menu.

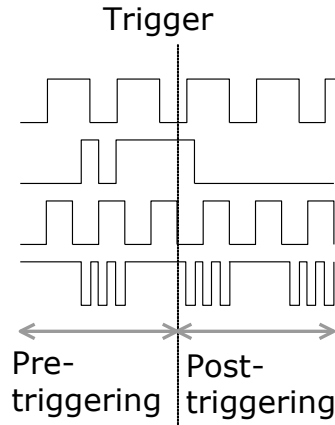

- 0% means GLA starts capturing data right after the triggering condition (no pre-triggering data).
- 50% means half of the captured data belongs to waveform prior to the triggering condition (default).
- 100% means all of the captured data belongs to waveform prior to the triggering condition.

Trigger delay

Toolbar icon

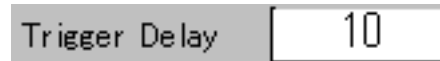

Delays the data capturing range in reference to the Trigger condition.

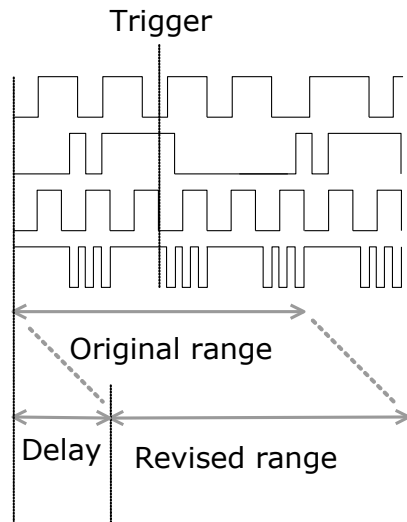

The amount of delay can be set as Time...

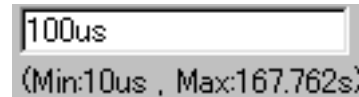

Or number of clocks.

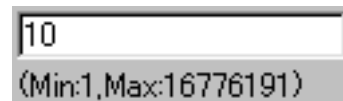

Trigger delay /
Trigger page

Trigger delay disables Trigger page function (page54), vice versa.



Enable Trigger Function Setup

Enable function lets GLA capture data portions only that match specified waveform condition – in other words, filters out unnecessary signal. The collected data portions are presented as a continuous stream of signal.

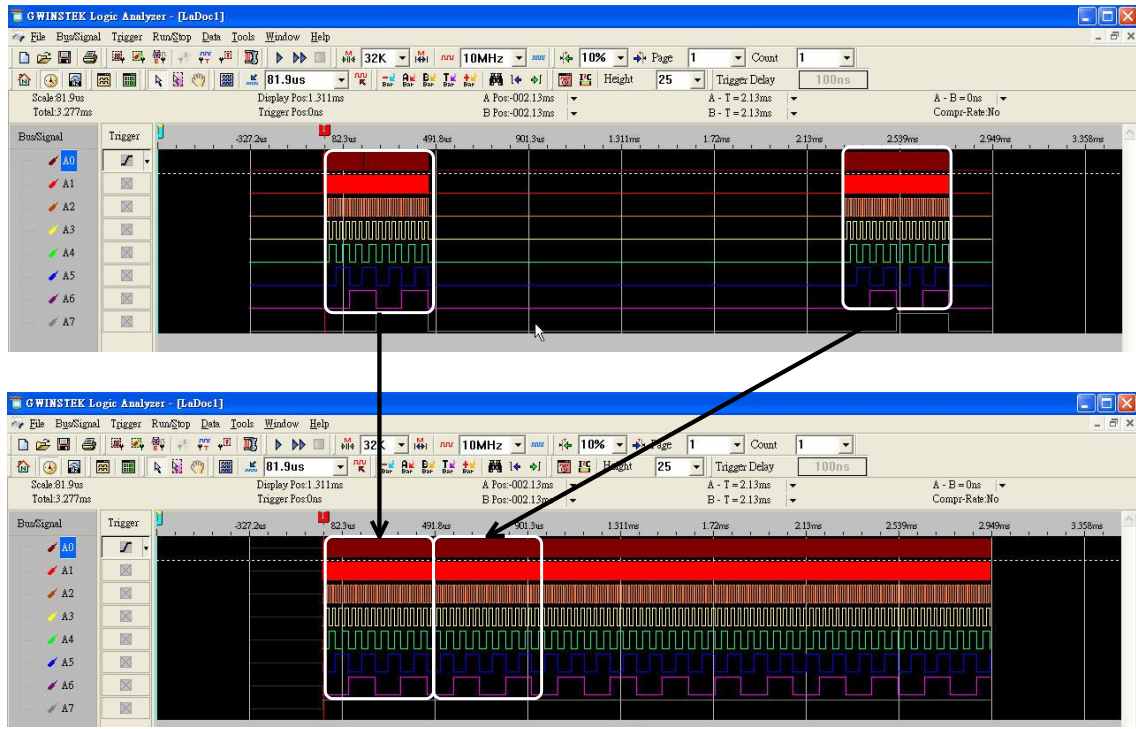

NOT available

- When using 128k byte memory for each channel (page41).
- When using the Compression mode (page42).

Menu

Select Sampling Setup from the Bus/Signal menu. Click Enable Setup button in the dialogue window.



Dialogue window

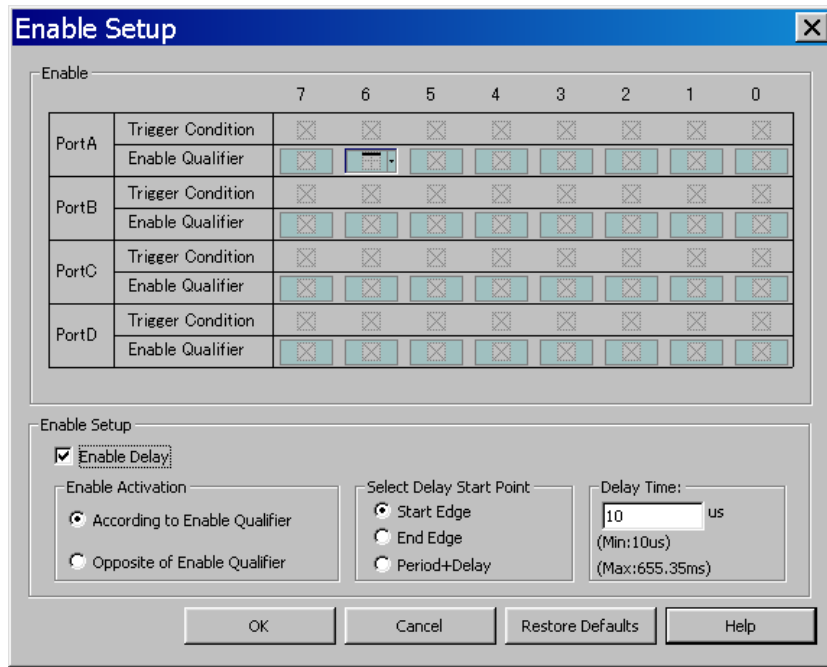

Enable Qualifier

Click on the target channel icon and select the condition.

Don't care

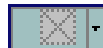

The signal level does not matter – always captured (default).

High

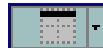

The signal level must be high.

Low



The signal level must be low.

Example

The following Enable condition means:

		7	6	5	4	3	2	1	0
PortA	Trigger Condition	⊗	⊗	⊗	⊗	⊗	⊗	⊗	⊗
	Enable Qualifier	■	■	■	■	■	■	■	■

GLA captures signals only when Port A has the following condition.

A0 ~ A7: 01101101



The minimum distance, between each Enable qualified data block, is 2 clocks. Otherwise (if the distance is only one clock) GLA continues capturing data and do not delete unnecessary bits.

Enable Period This options controls when GLA actually captures data, in reference to the Enable Qualifier condition set.

Check the Enable Delay radio button.



According to GLA captures signals when input signals match the Enable Qualifier.

Opposite of GLA captures signals when input signals DO NOT match the Enable Qualifier.

Delay Start Point This function fine-tunes the length of captured waveform, in reference to the Enable Qualifier condition. Delay Time configures the length of time (user-defined). Three types of delay setting, Start Edge, End Edge, and Period+Delay are available.

Example Enable Qualifier

A0 ~ A3 condition is set as follows.

Enable Qualifier condition: 0001, Delay Time: 100us

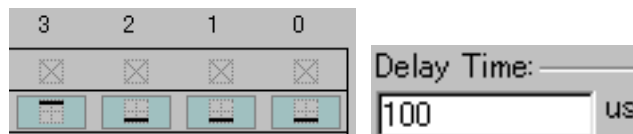

Start Edge GLA starts recording (capturing) signals at the beginning of Enable Qualifier match, for the Delay Time duration.

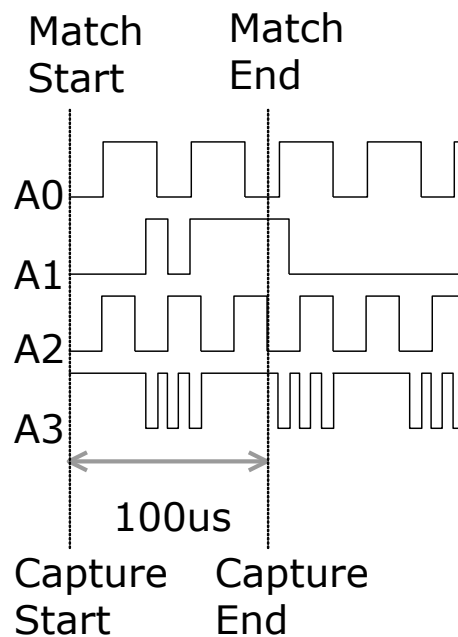

End Edge

GLA starts recording (capturing) signals at the end of Enable Qualifier match, for the Delay Time duration.

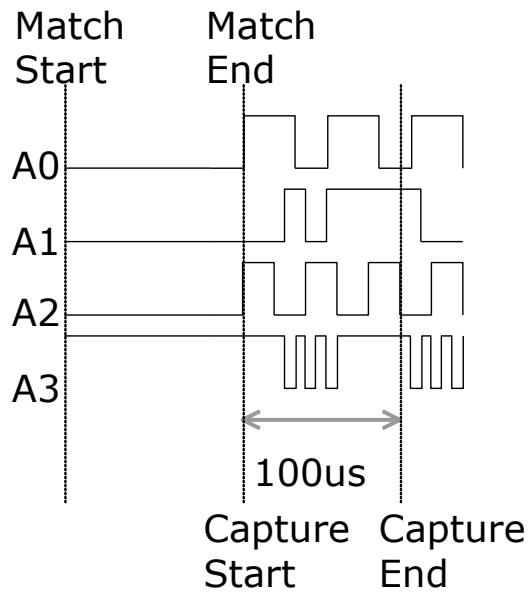

Period + Delay

GLA starts recording (capturing) signals at the beginning of Enable Qualifier match, continues after the end of match for the Delay Time duration.

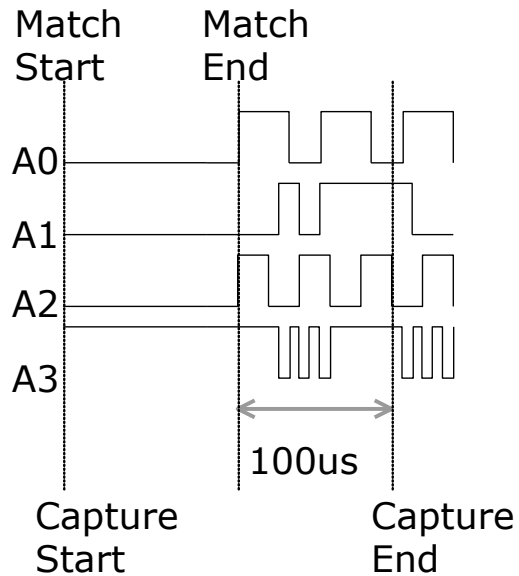

When completed...

When the Enable setting is completed, press OK (confirm) or Cancel button. Restore Defaults disables all the qualifier settings.



Trigger Output Signal

GLA has three output signals which can be used for monitoring trigger condition.

Connector

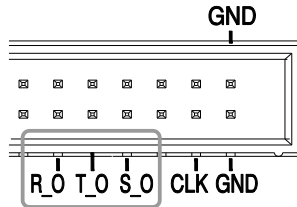

Three signals, S_O, T_O, and R_O, output high level (3.3V) under specific conditions.

Signal description

S_O
(Start Out)

Outputs high level from when the Start key is pressed, or the Run command becomes active, until the end of data capturing.



or F5

T_O
(Trigger Out)

Outputs high level from when the trigger condition is met, until the end of data capturing.

R_O
(Read Out)

Outputs high level from when the data capturing has finished (GLA starts transferring data to PC) until the transfer is completed.

Diagram

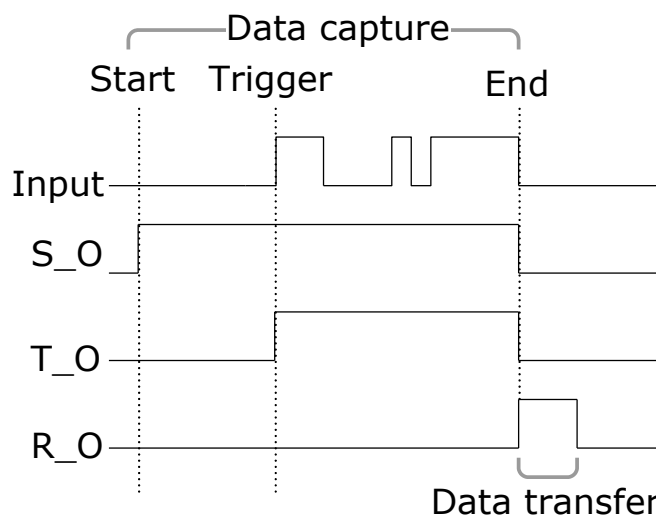

GLA cannot capture the next data while R_O is high (data transfer not completed yet).

Display Setup

Toolbar setup	Toolbar Setup	63
	Toolbar list	64
Horizontal / Vertical scale setup	Horizontal unit.....	65
	Horizontal ruler	65
	Waveform height	66
Waveform view setup	Signal display	67
	Enable/Disable grid.....	68
	Square/Sawtooth waveform	69
	Waveform timing display.....	69
Color setup	Background color	71
	Waveform (Foreground) color	72

Toolbar Setup

Menu



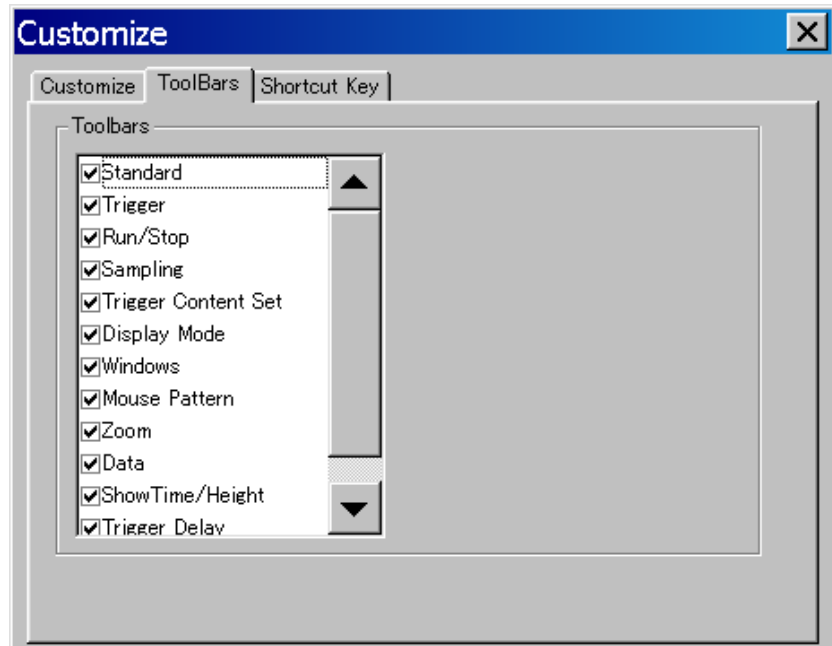





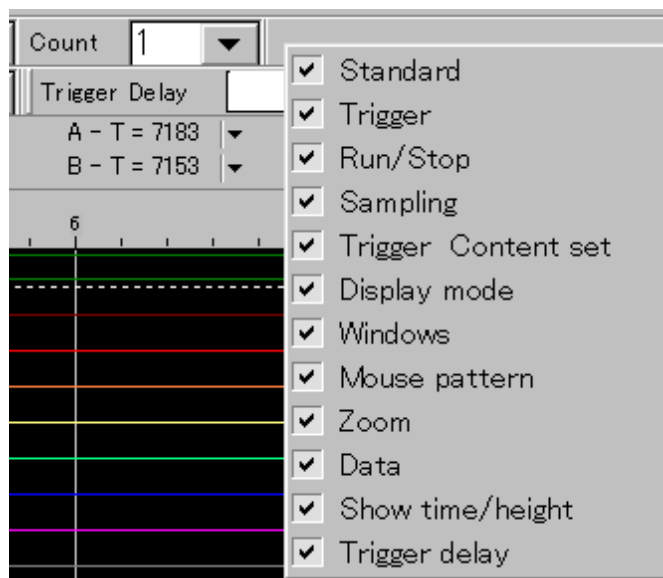

Select Customize from the Tools menu. Click the Toolbars tab. Click the target toolbar to activate/deactivate it.



Context menu

Right-click on the blank space in the Toolbar. Click the target toolbar to activate/de-activate each group.

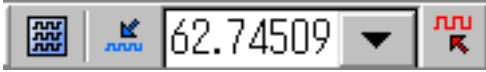

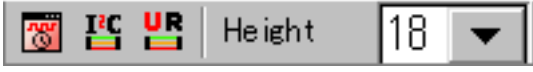
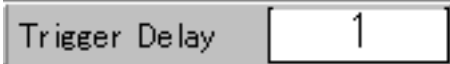
Toolbar list	Standard	
	Trigger	
	Run/Stop	
	Sampling	
	Trigger Content Set	
	Display Mode	
	Windows	
	Mouse Pattern	
	Zoom	
	Data	
	Show Time/Height	
	Trigger Delay	

Horizontal/Vertical Scale Setup

Horizontal unit

Sets the horizontal unit used in the Scale and Position bar.

Menu **Tools** → **Customize ...**

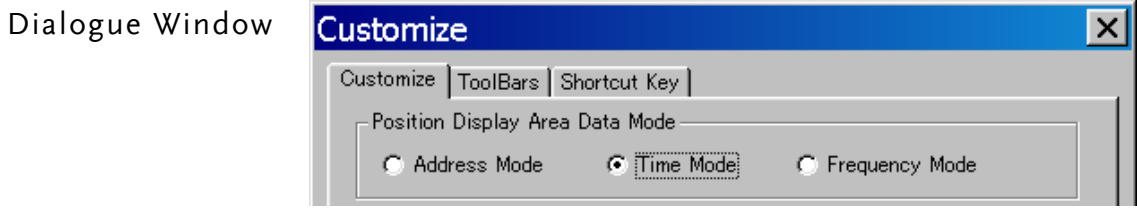

Icon & Display	Address mode (default)	Time mode	Frequency mode
	Scale:1.59375	Scale:15.938ns	Scale:62.745MHz
	A - T = 15	A - T = 150ns	A - T = 6.667MHz

Horizontal ruler

Sets the horizontal ruler scale.

Menu **Tools** → **Customize ...** → **Customize**



Display Regular Scale (default)

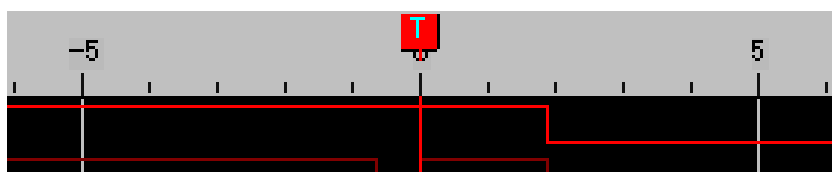

Time/Address Scale

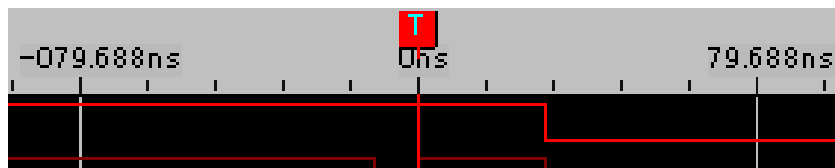

Waveform height

Sets the signal/bus displayed height.

Menu **T**ools → **C**ustomize ... → **C**ustomize

Toolbar icon **H**eight 18 ▼

Dialogue Window **B**us/Signal Height

18 ▼

Range 18 (default) ~ 100 points

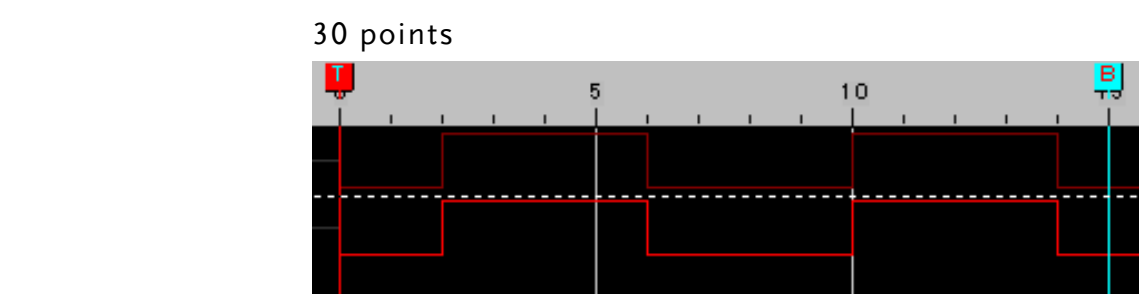
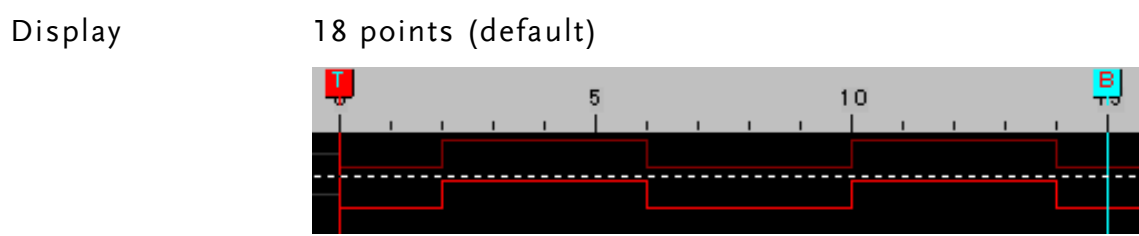

Signal Display Setup

Signal display

Sets the viewing style for signals and buses.

- Waveform view puts each channel waveform horizontally.
- Listing view puts each channel vertically, in binary form.

Menu



Toolbar icon

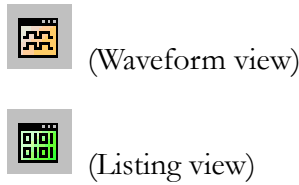

Waveform view
(default)

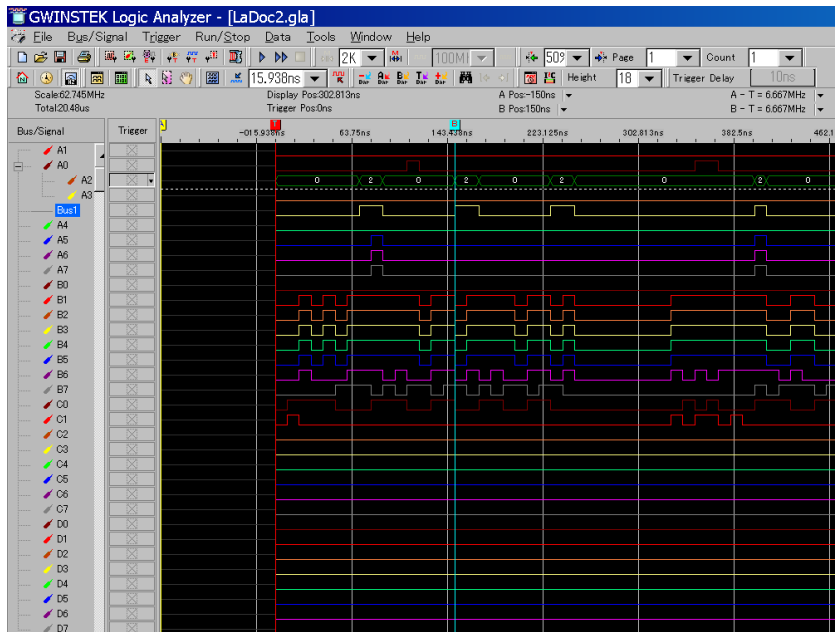

Listing view

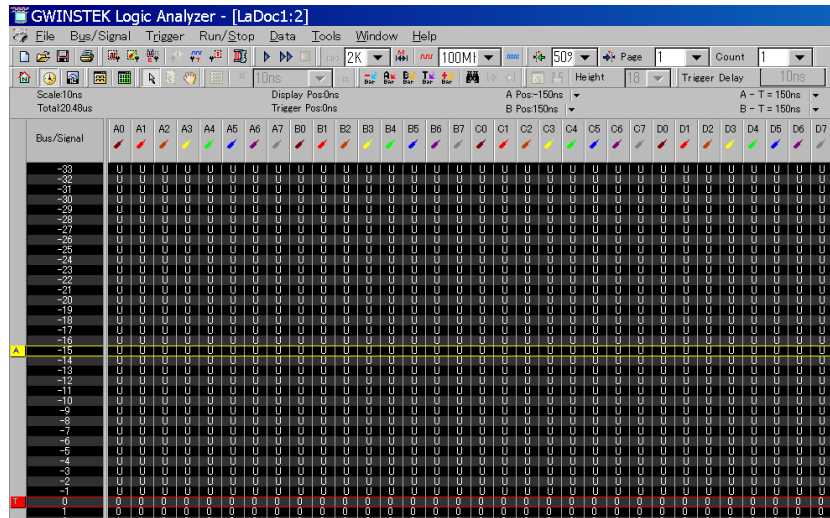

Enable/Disable grid

Show/hide the vertical gridline in the waveform area.

Menu

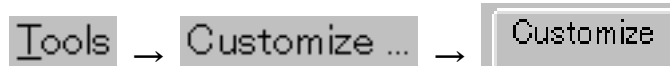

Dialogue Window

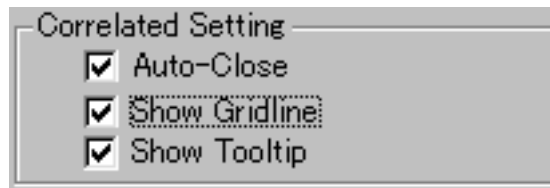

Display

With grid (default)

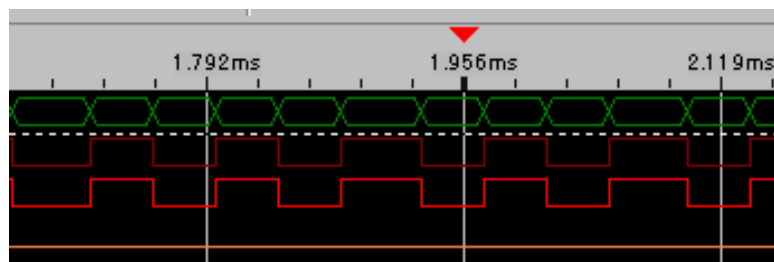

Without grid

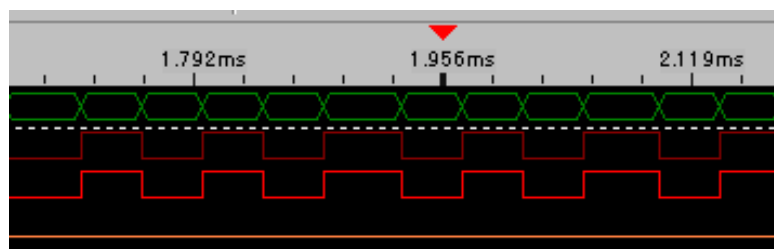

Square/Sawtooth waveform

Selects the waveform edge shape.

Menu

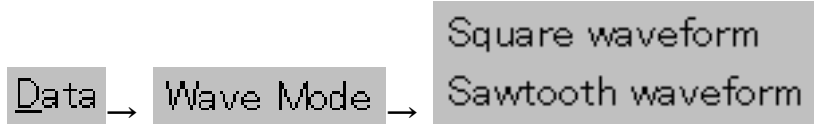

Context menu

Right-click on the waveform area and select Wave Mode.

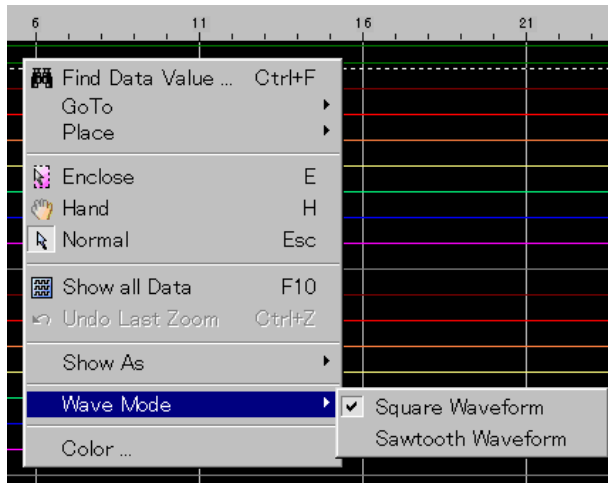

Display

Square waveform (default)

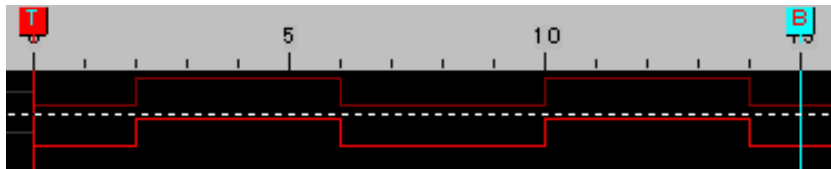

Sawtooth waveform

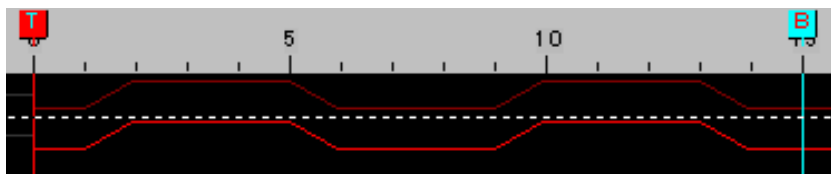

Waveform timing display

Shows/hides timing information inside waveforms.

Menu



Toolbar icon



Display

Without timing information (default)

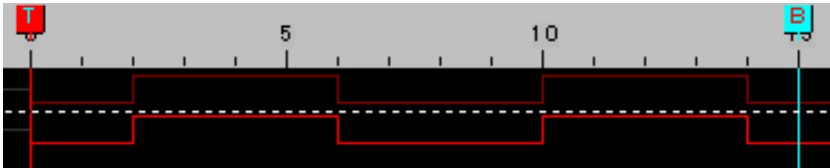

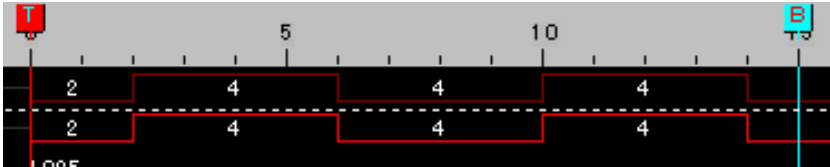

With timing information



Color Setup

Background color

Sets the waveform background color.

Menu  →  → 

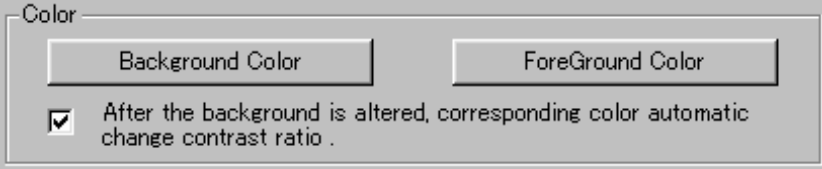
Dialogue Window 

Change color Press the Background Color bar. 



Click the color bar and select color from the color chart.

Contrast with foreground Check the radio if you want the foreground (waveform) color to be automatically adjusted, following the background color change.

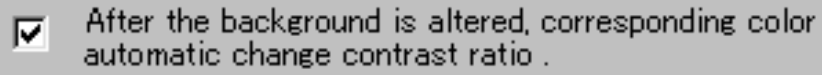

Display Black background (default)

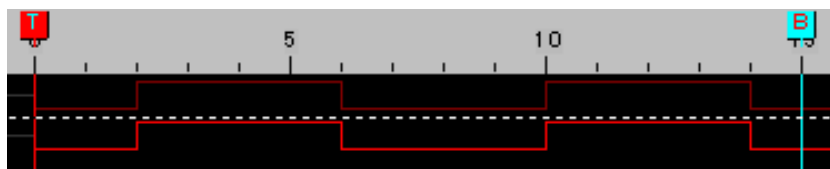

White background

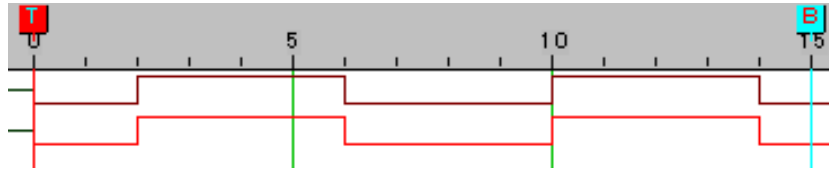

Waveform (Foreground) color

Sets the waveform color.

Menu

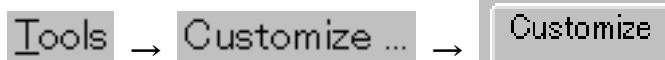

Dialogue window

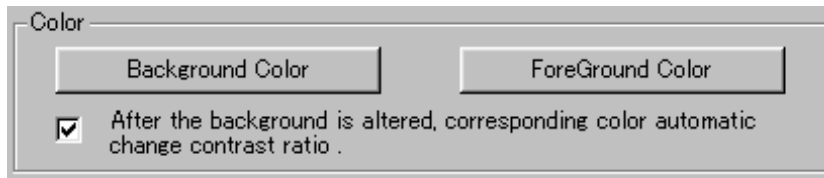

Context menu

Right-click on the Bus/Signal list, Trigger list, or on the waveform, select Color menu. The target waveform color can be changed on the spot.

Bus/Signal list

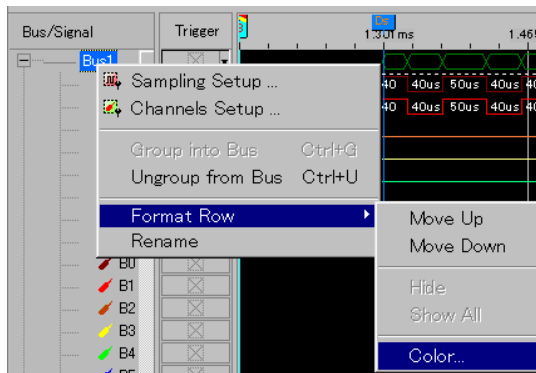

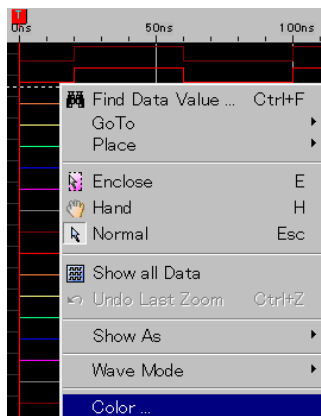

Waveform

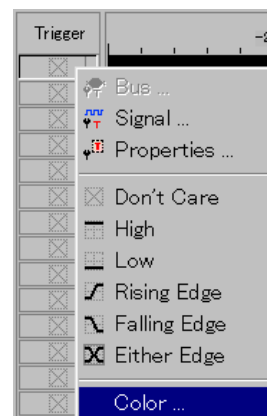

Trigger list



Dialogue Window

Use the single arrow  to change individual waveform color.
 Use the dual arrows  to change all waveform colors at once.

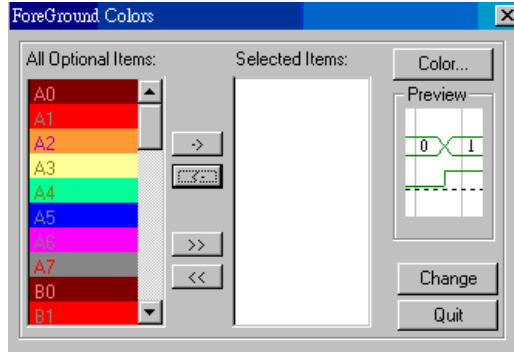

Restore default settings

When the changes become complicated, use the Restore button  in the Configure dialogue window.

Signal Capturing

This chapter describes how to run/stop capturing signals.

Single Run

Captures data for a single period.

Menu Run/Stop → ▶ Single Run

Toolbar icon 

Shortcut key F5

Panel operation  Press the Start switch.

Capturing succeeded Toolbar icon (go back to default) Status bar (left bottom)
 End !!!

Capturing failed Toolbar icon Status bar (left bottom)
 Waiting.

Continuous Run

Continuously captures data. Once the memory becomes full, GLA dumps the waveform data on the display, then restart capturing. This process is repeated until the Stop command (see next page) is issued.

Menu Run/Stop → ▶▶ Repetitive Run

Toolbar icon 

Shortcut key F6

Capturing succeeding Status bar (bottom left) keeps updating the amount of captured data in reference to the memory.



Capturing failed Status bar (bottom left) stays in the waiting mode.



Data is not captured while GLA is dumping stored waveform data on the display.

Stop Running

Stops capturing data.

Menu Run/Stop → Stop

Toolbar icon 

Shortcut key F7

Capturing stopped

Toolbar icon (go back to default)



Status bar (left bottom)

End !!!

Data Operation

Once GLA captures the data, several operations become available. This chapter describes how to search, view, and analyze the captured data effectively.

Data bar operation	Activate data bar	77
	Add/Delete data bar	78
	Move data bar	79
Waveform position	Waveform Position	81
	Move the cursor up/down	82
Data search	Data Search.....	83
	Data Search Step.....	83
	Bus search step.....	85
Zoom	Zoom In/Out.....	87
	Enclose (flexible ratio zoom).....	88
	Show all data.....	88
	Manual Display/Analysis Range Setting	89
I ² C bus analysis	I ² C Bus Analysis.....	90
	Analysis step.....	91
RS-232 signal analysis	RS-232C Signal Analysis.....	94
	Analysis step.....	95
Waveform statistics	Waveform Statistics.....	97
	Statistics setup step.....	97

Data Bar Operation



Data bar shows the signal position which can be used as a place marker. Using the data bar, you can measure relative time, frequency, and points between data.

Activate data bar

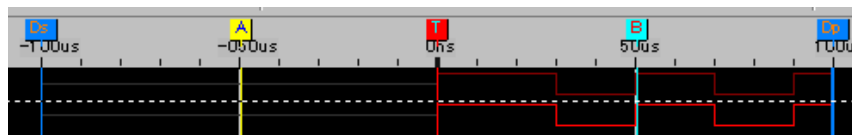
Default state Five data bars are available by default: From left, Ds (start range) A, T (trigger), B, and Dp (end range).



Unit Data bar unit is selectable from address point, time, and frequency. Press the toolbar icon to select. For unit selection details, see page65.

Address mode	Time mode	Frequency mode
		
A - T = 15	A - T = 150ns	A - T = 6.667MHz

Position The positions of the bars are shown on the toolbar. A Pos:-15 |
B Pos:15 |

Click the arrow  to select the displayed bar.



Relative distance The distance between each bar is also shown on the toolbar. A - T = 15 |
B - T = 15 |
A - B = 30 |

Click the arrow icon  to select the displayed distance.

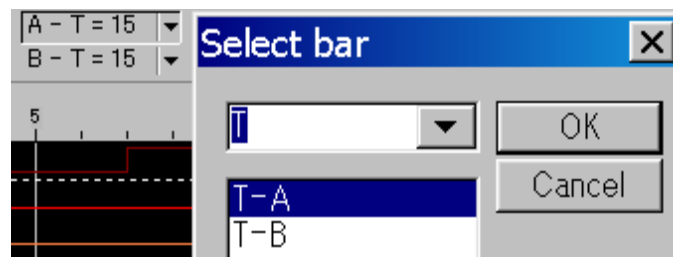

Add/Delete data bar

Add a bar

Menu



Toolbar icon



Dialogue window

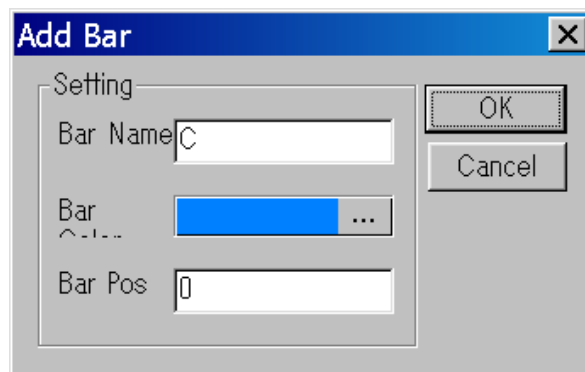

You can specify the bar color and position.

Delete a bar

Menu



Toolbar icon



Dialogue window

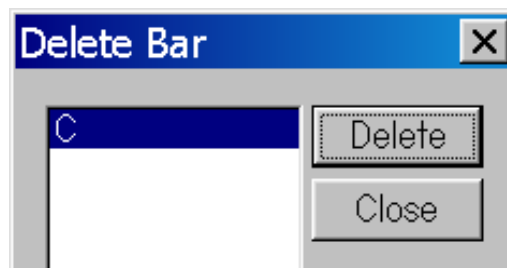

Select the added bar and delete it.

Note: The default bars (T, A, B, Ds, Dp bar) cannot be deleted.

Move data bar

Move a bar manually

Toolbar icon



Move the bars manually using the mouse. Point the arrow close to the bar until it changes into Hand shape or double arrow. Move the bar right or left.

Note: The T bar position is fixed to the center.

Hand

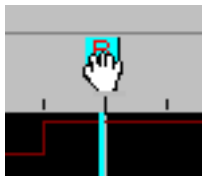

Double arrow

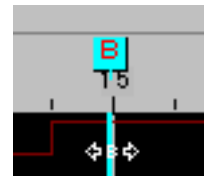

Move a bar to the pointed location

You can move a bar to the exact location that you point in the display.

Right-click the location you want to move the bar, in the display. Select Place from the context menu.

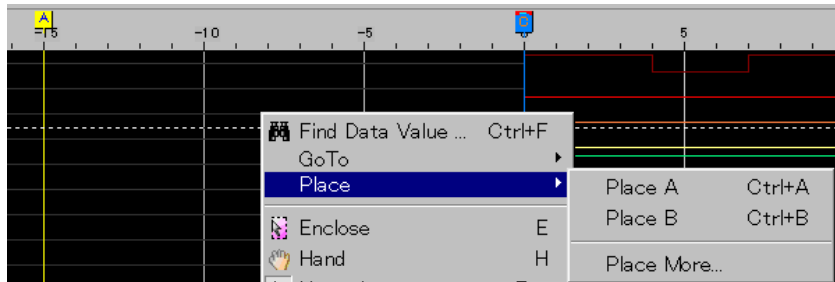

The target bar (in this case, A bar) moves to the click location.

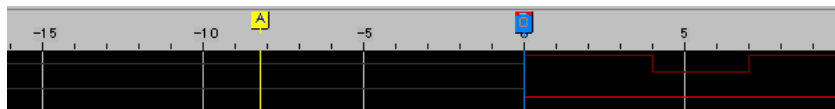

For moving bars other than A or B, select the

Place More...

Note: The T bar position is fixed.

Move a bar to the display center

Move the bars to the center position of the display instantly.

Menu

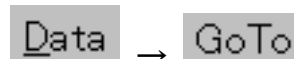

Toolbar icon

 (T bar)

 (B bar)

 (A bar)

Shortcut key T (T bar)/ A (A bar)/ B (B bar)

Context menu

Right-click on the display and select Go to.

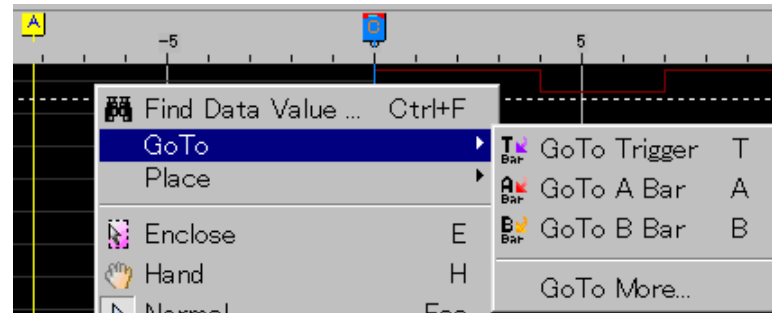

Automatically adjust bar position to signal edge

When this option is enabled, the bars automatically moves to signal edges when there are close.

Menu

Tools

→

Customize ...

→

Customize

Check the Auto-Close radio.



Waveform Position

Here we describe how to move the whole waveform display together.

Move the previous edge to the center

Search the previous data edge of the selected signal, move it to the display center.

Menu

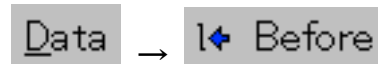

Icon



Shortcut key

F11

Move the next edge to the center

Search the next data edge of the selected signal, move it to the display center.

Menu



Icon



Shortcut key

F12

Move the display left-right manually

Move the display area left or right manually. The mouse arrow changes into Hand style, allowing direct manipulation of waveform positions.

Menu



Icon



Shortcut key

H

Context menu

Right-click on the display area and select Hand.



Move the cursor up/down

Menu



Shortcut key

Up/Down

Context menu

Right-click on the Bus/Signal list, select Format Row menu.

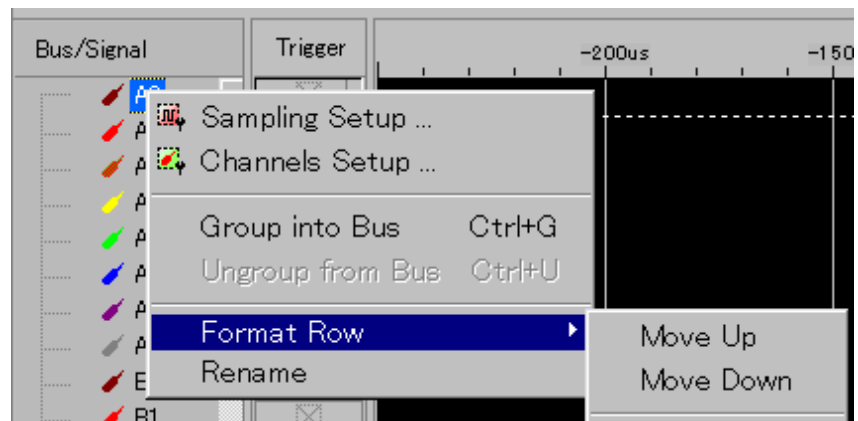

Data Search

Search data in the waveform and move the data bars.

Menu



Icon



Shortcut key

Ctrl+F

Context menu

Right-click on the display and select Find Data Value.

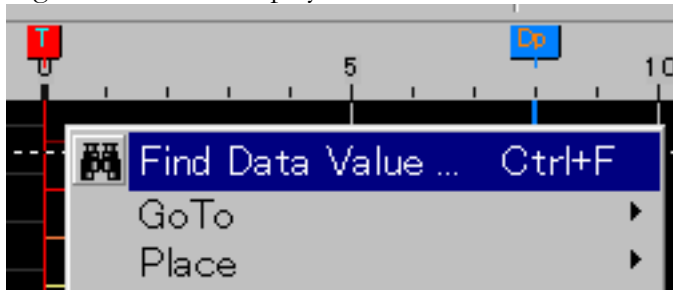

Dialogue window

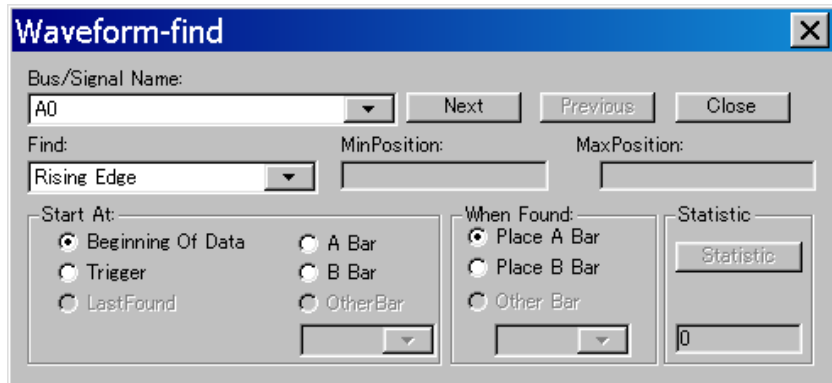

Data Search Step

1. Select the signal.



2. Select the signal condition.

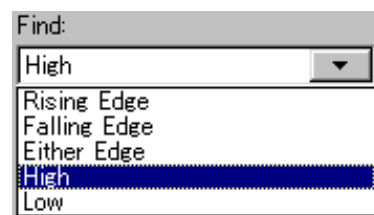

Rising Edge



Falling Edge



Either Edge



High



Low



3. Select the search start position.

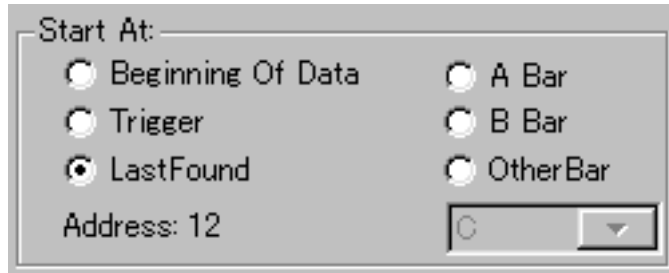

Beginning	The beginning of the captured data.
Trigger	Where the trigger condition occurred.
Last Found	Where the last data search ended (available after at least one data search).
A Bar	A Bar position.
B Bar	B Bar position.
Other Bar	The bar other than A or B. Click  Bar Toolbar icon for adding a new Bar. For more details, see page43.

4. Select which bar to place when the target data is found.



5. Search the data. Press Next or Previous, to search forward or backward in the waveform.



Bus search step

1. Select the Bus.

2. Select the Bus condition.

Normal Bus

I²C Bus

3. Set the Bus value range.
Enter the value directly into Minimum and Maximum column.

==	Search the Bus condition where its value equals the MinPosition value.
Not=	Search the Bus condition where its value is NOT equal to the MinPosition value.
In Range	Search the Bus condition where its value is within the Min/Max Position range.
Not In Range	Search the Bus condition where its value is outside the Min/Max Position range.

4. Select the search start position.

Beginning	The beginning of the captured data.
-----------	-------------------------------------

Trigger	Where the trigger condition occurred.
Last Found	Where the last data search ended (available after at least one data search).
A Bar	A Bar position.
B Bar	B Bar position.
Other Bar	The bar other than A or B. Click  Toolbar icon for adding a new Bar. For more details, see page78.

5. Select which bar to place when the target data is found.



6. Search the data. Click Next or Previous, to search forward or backward in the waveform.

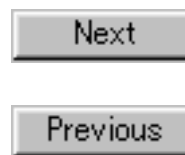

7. To see the total number of data match, click the statistic button.



Zoom In/Out

Zoom in	Menu	
	Toolbar icon	
	Shortcut key	F9
	Zoom ratio	x2

Zoom out	Menu	
	Toolbar icon	
	Shortcut key	F8
	Zoom ratio	÷2

Undo the last zoom	Menu	
--------------------	------	--

Shortcut key Ctrl+Z

Context menu

Right-click on the signal display and select Undo Last Zoom.

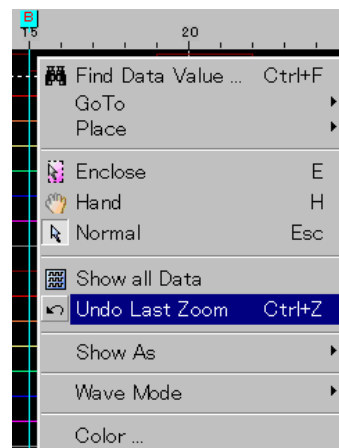

Enclose (flexible ratio zoom)

Enclose function zooms the selected area into full screen horizontal size. When selected, the mouse arrow changes into a cropping tool to select the zoom range.

Menu



Icon



Shortcut key

E

Context menu

Right-click on the signal display and select Enclose.

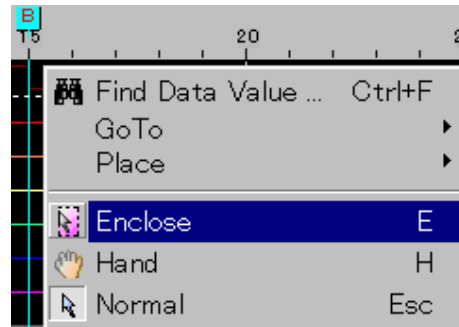

Show all data

Squeeze and show all the captured data into a single screen.

Menu

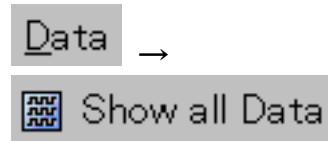

Icon



Context menu

Right-click on the signal display and select Show all Data.

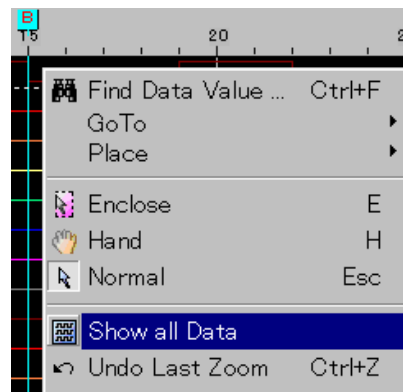

Manual Display/Analysis Range Setting

You can set the display range manually, OR

You can limit the range of data for I2C (page90), or RS-232 (page94), or Waveform statistics (page97) analysis, to delete unnecessary chunk of data.

Menu

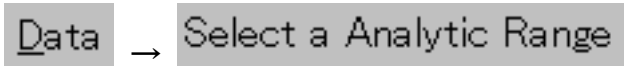

Selection step

The pointer changes into a hand tool. Grab the Ds (Start point) and Dp (End point) bar and move it manually or press the toolbar icon to adjust the displayed range automatically.

Start point End point Manual setting Automatic setting

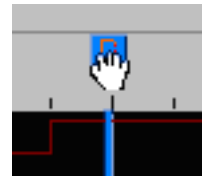
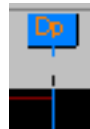
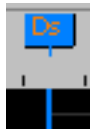

Example

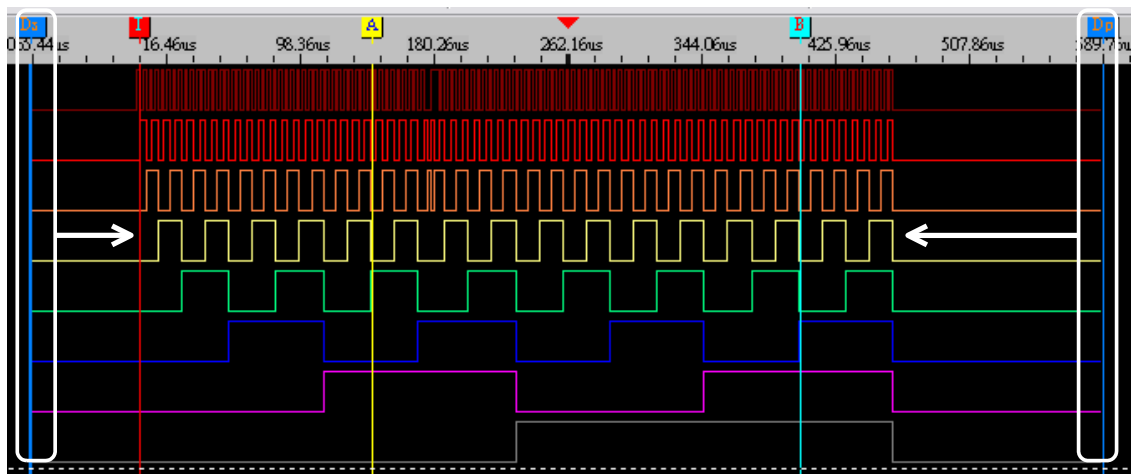

I²C Bus Analysis

Background

This function analyzes the widely popular I²C (Inter-Integrated Circuit) bus protocol by extracting the attributes from the captured data.

The bus consists of two lines, SDA (Serial Data Line) and SCL (Serial Clock Line).

The Data consists of the following elements.

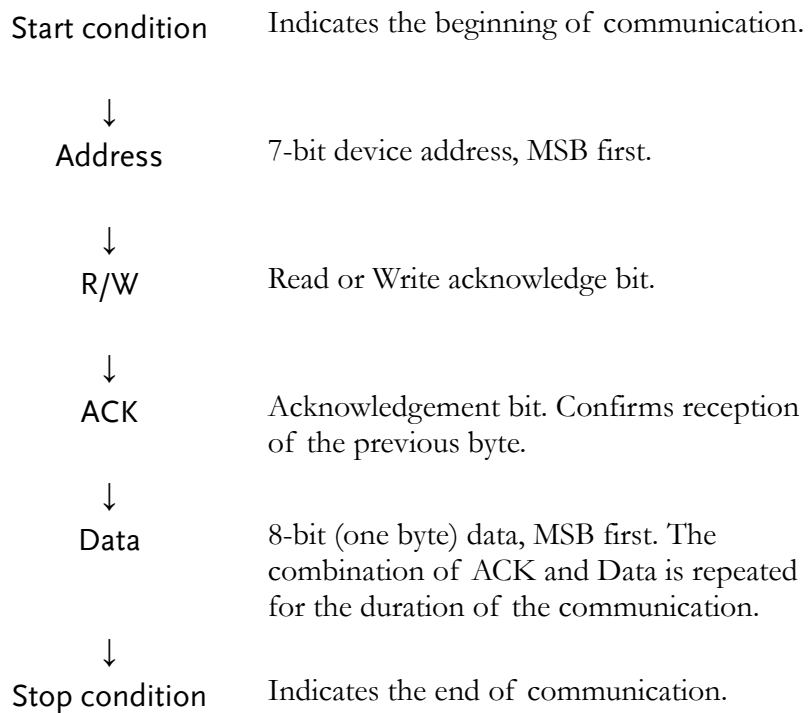

Menu

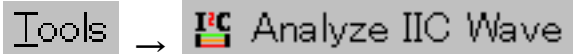

Icon



Dialogue window

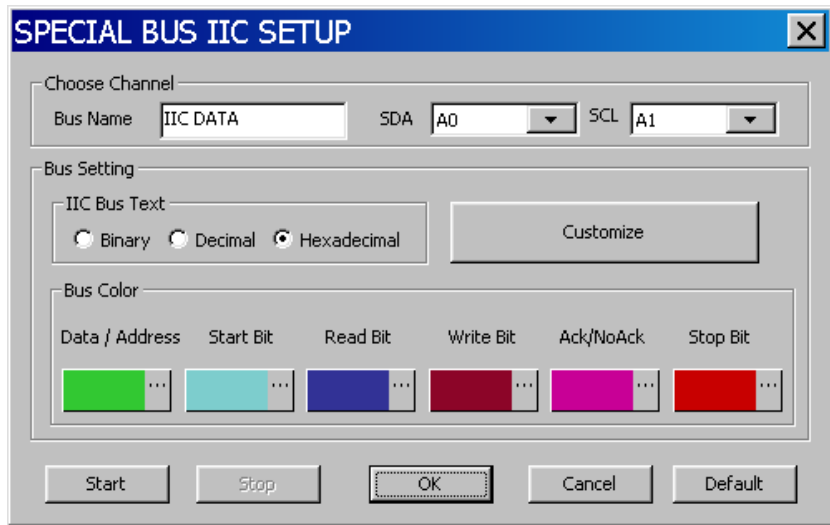

Analysis step

1. Limit the analysis range if necessary. Select “Select Analytic Range” from the Data menu. Limit the analysis range by

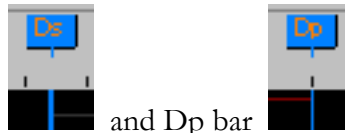

moving Ds and Dp bar. For details, see page89.

2. Enter the name of the new I²C Bus, created upon analysis



completion.

3. Select the SDA (Serial Data Line) and SCL (Serial Clock Line) channel.



4. Select how the I²C Bus value will be displayed: Binary, Decimal, or Hexadecimal.

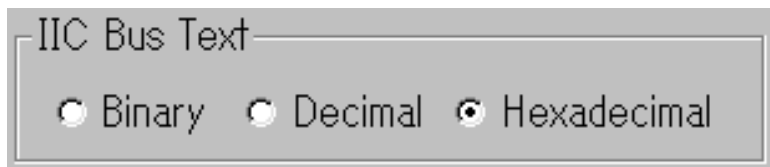

5. Select the color of the new I²C analysis Bus. Click each bus element's color bar and select a new color from color chart.

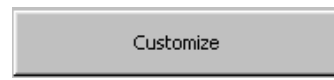
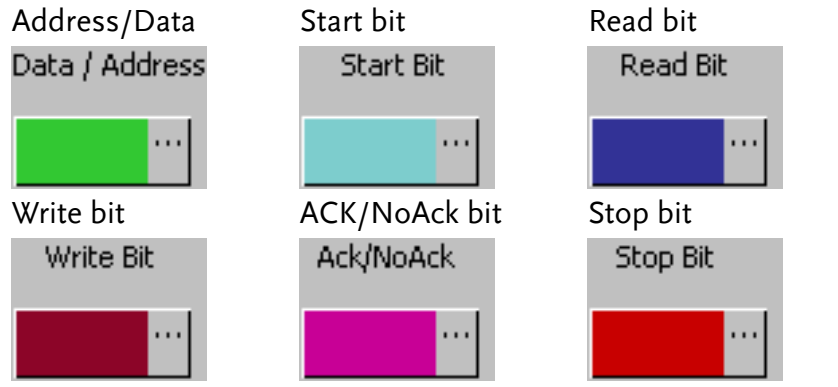

- Click the I2C Customize button and open the Customize window.

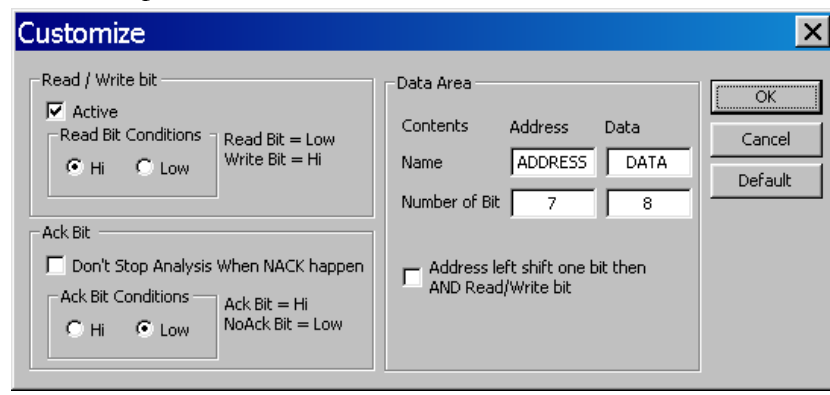

- Select the Read/Write bit activation and polarity. Click the Active radio button and activate or deactivate Read/Write bit.

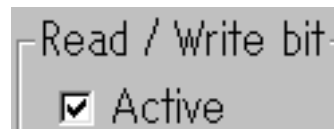

- In active mode, click the Read Bit Conditions radio button and select the polarity. The Write Bit gets the opposite polarity.



- Select whether the NACK (Non-acknowledge) sign stops I²C analysis or not.

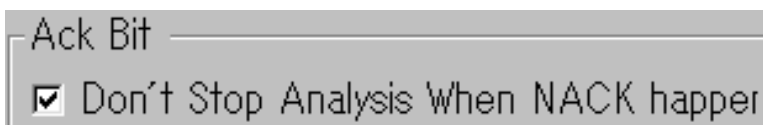

10. Select the ACK bit polarity.
NoACK bit gets the opposite polarity.



11. Enter the Data/Address display name and their bit length.



12. Address can be shifted one bit left and then ANDed with Read/Write bit.

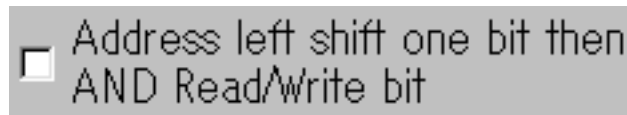

13. Press OK, Cancel, or Default.
Default.
Default contents:
Read/Write active
Read Bit High
Stop analysis upon NACK
Ack Bit Low
Address 7 bit/Data 8 bit
No Address shift



14. Start/Stop I²C analysis.



A new I2C bus will be created with the result shown as configured.

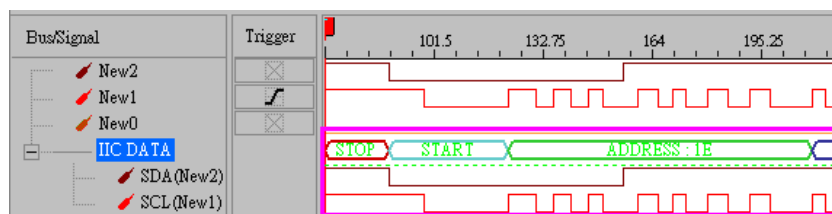

RS-232C Signal Analysis

Background

This function analyzes the RS-232C signal protocol by extracting the attributes from the captured data.

RS-232C consists of a single line, including the following elements.

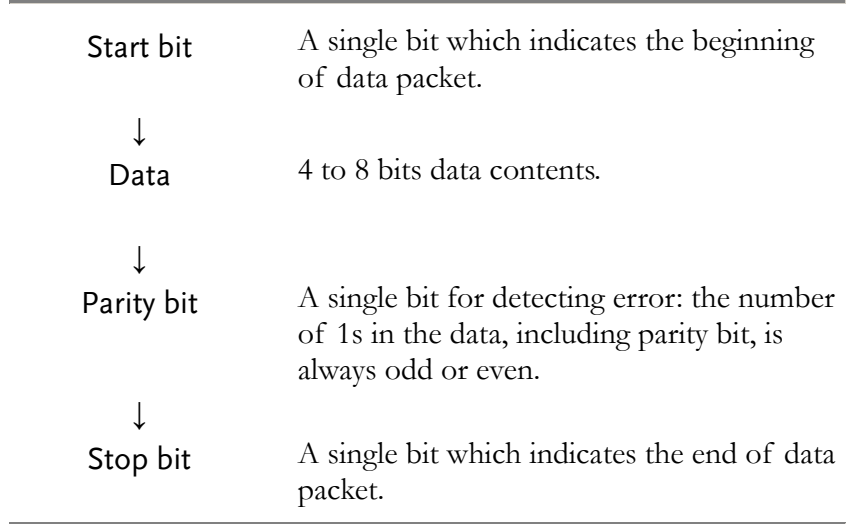

The other elements include:

- Baud Rate** The transmission speed: 300 ~ 115200 bit/s.
- Direction** The data order: MSB or LSB first.

Menu



Icon



Dialogue window

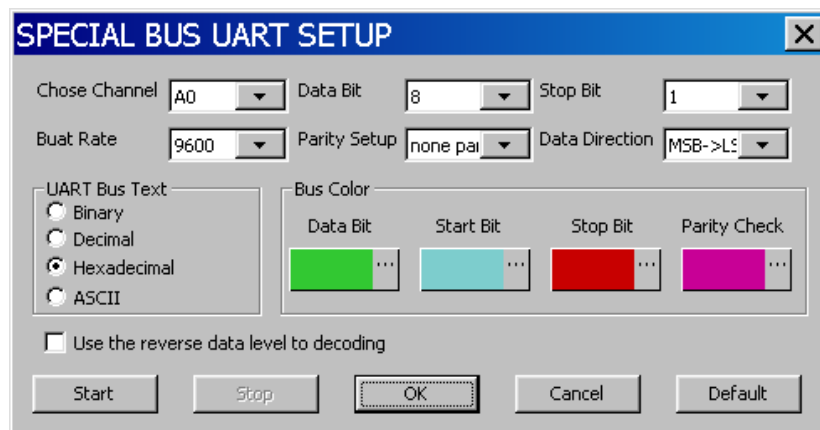

Analysis step

1. Limit the analysis range if necessary. Select “Select Analytic Range” from the Data menu. Move Ds and Dp bar and limit the range. For details, see page89.

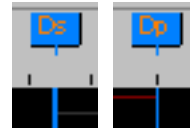

2. Select the signal channel.



3. Select the Baud rate.



4. Select the Data Bit: 4 ~ 8.

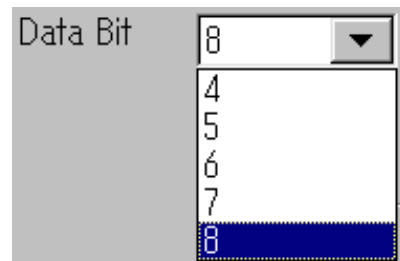

5. Select the Stop Bit width: 1, 1.5, 2.

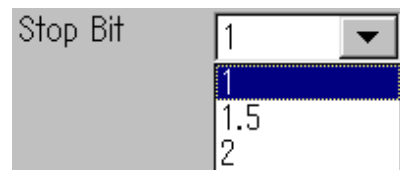

6. Select the Parity: none, odd, even.

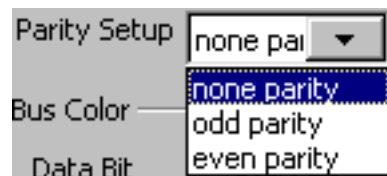

7. Select the Data direction: MSB first, or LSB first.



8. Select how the data value is displayed in the analysis result: binary, decimal, hexadecimal, or ASCII text.

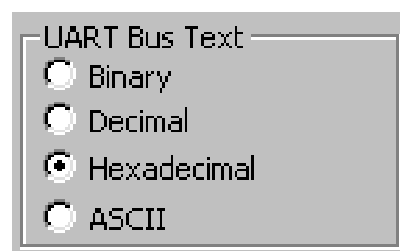

9. Select the color of the RS-232 analysis result. Click each element's color bar and select a new color from color chart.

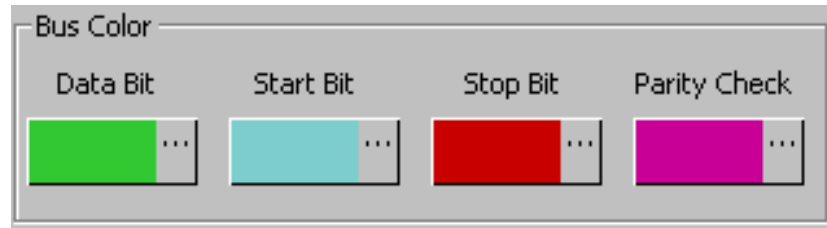

10. If the reversed polarity data should be used, click the radio.



11. Start/Stop RS-232 analysis.



The result is displayed as configured.

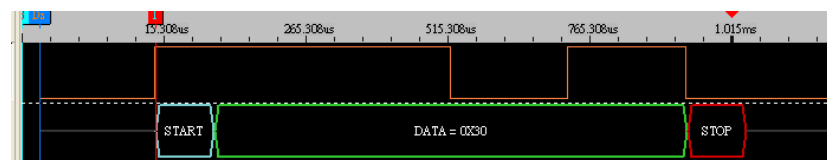

Waveform Statistics

The Statistics function shows the number of cycles included in the waveform. Cycle period and waveform range are configurable.

Toolbar icon



Dialogue window

The statistics window appears at the bottom of the display.

CHANNEL	Integrated ...	Positive per ...	Negative p...	Eligible inte...	Eligible posi...	Eligible neg...
A0	3	3	3	0	0	0
A1	3	3	3	0	0	0
A2	0	0	1	0	0	0
A3	0	0	1	0	0	0
A4	0	0	1	0	0	0

Definition

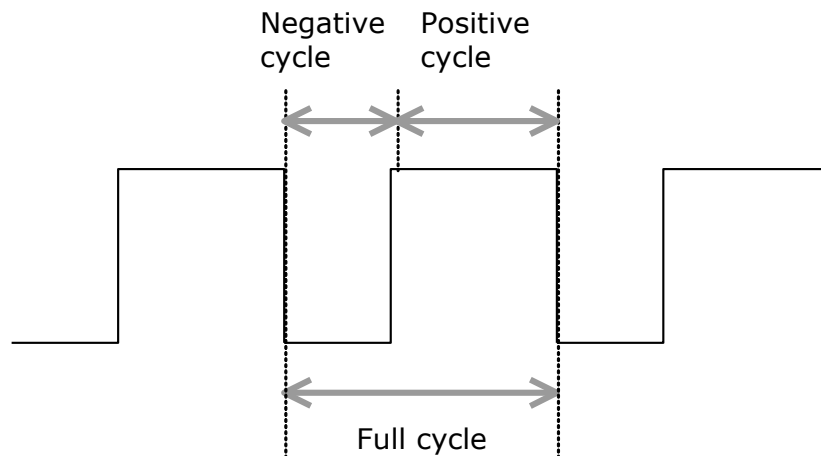

Statistics setup step

1. Limit the analysis range if necessary. Select "Select Analytic Range" from the Data menu. Move Ds and Dp bar and limit the range. For details, see page89.



2. Press the Statistics icon. The statistics window appears.



3. Select the target channel if necessary. Press the Channel Option button. The option window opens. Check or uncheck the signals.

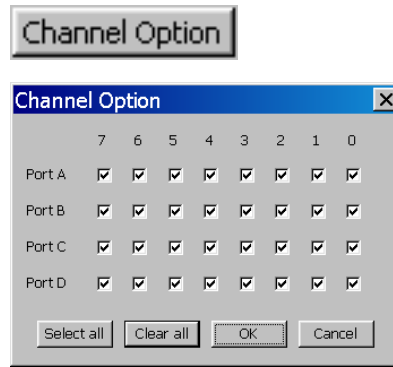

4. Select the included item. Press the Item Option button. The Item selection window appears. Check (uncheck) items to be included (excluded) in the statistics window.

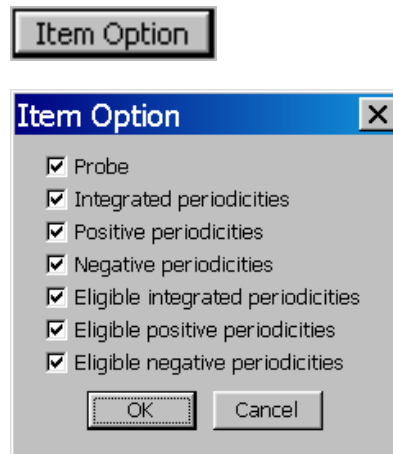

Probe	The probe name for each signal.
Integrated periodicities	The number of full cycles included in the waveform.
Positive periodicities	The number of positive cycles included in the waveform.
Negative periodicities	The number of negative cycles included in the waveform.
Eligible integrated periodicities	The number of full cycles included in the waveform, which meet the conditions (see below).
Eligible positive periodicities	The number of full cycles included in the waveform, which meet the conditions (see below).
Eligible negative periodicities	The number of full cycles included in the waveform, which meet the conditions (see below).

- Set the cycle period condition, if necessary. Press the Condition Option button. The conditions window opens. Make sure the radio is checked.

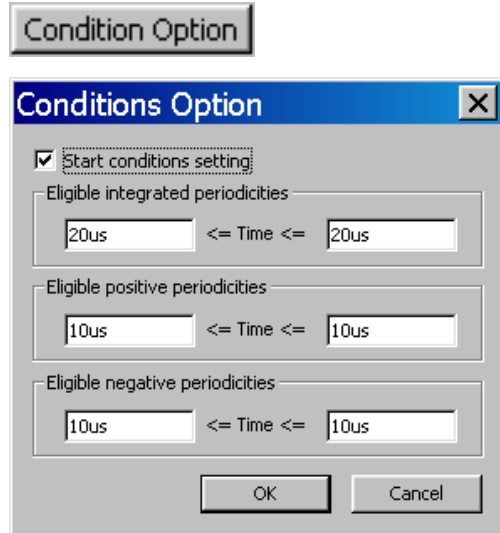

<input checked="" type="checkbox"/> Start conditions setting	Full cycle period, in ns/us/ms/s. GLA counts the number of full cycle that has the same period.
Eligible integrated periodicities	
Eligible positive periodicities	Positive cycle period, in ns/us/ms/s. GLA counts the number of positive cycle that has the same period.
Eligible negative periodicities	Negative cycle period, in ns/us/ms/s. GLA counts the number of negative cycle that has the same period.

- Check the Filter radio to filter out incomplete data.



- Press the Refresh button. The statistics windows updates the result.



System Setting

Keyboard Shortcut Setup

Shows the model name and software version. The default setting can be viewed from the setup dialogue window, or from Help menu → Keyboard Map, or this user manual page16.

Menu

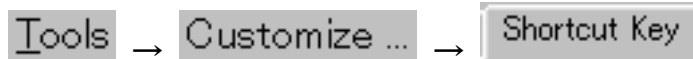

Dialogue Window

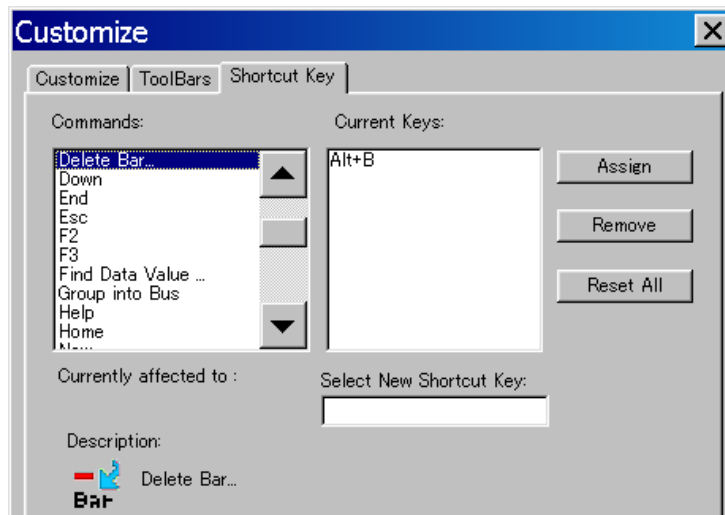

Assign a new shortcut

Click inside the New Shortcut key window and press the keys.

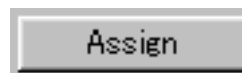

Click the Assign button.

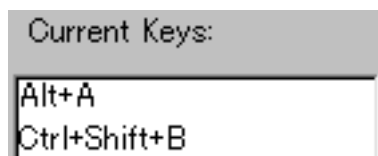

The new shortcut is added to the list.

Remove a
shortcut

Select the target shortcut key inside the Current Keys window.

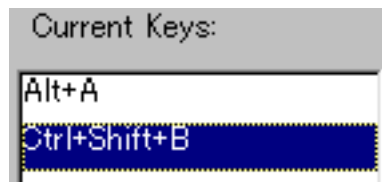

Click the Remove button.



The shortcut gets deleted.

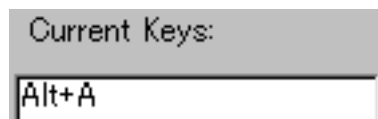

Restore default

Click the Reset All button.

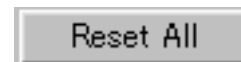

All shortcut keys settings goes back to the default state.

System Information

Version Information

Shows the model name and software version.

Menu **Help** → **? About GWINSTEK Logic Analyzer**

Dialogue Window



Automatic Software Update

GLA checks the software update at power up, then automatically installs the applicable files.

Menu Check On/Off the Update radio button.
Tools → **Customize ...** → **Check for Update**

 **Internet connection** GLA checks the update information by accessing the server on the web. When there is no internet connection, a warning message will be generated.

Help Information

Main Help

Opens the main Help file, which includes this manual contents.

Menu 

Shortcut key F1

Keyboard Shortcut

Opens the keyboard shortcut file.

Menu 

Tooltip

Shows/hides popup window for showing brief descriptions when the mouse scrolls over toolbar icons and waveforms.

Menu Check On/Off the Show Tooltip radio button.

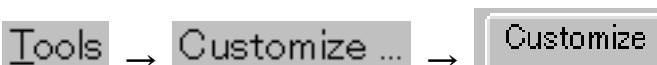

Dialogue window

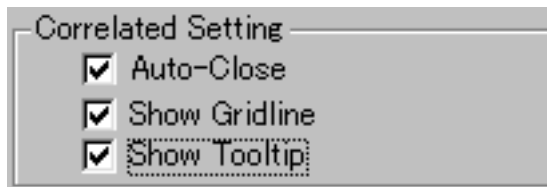

Example

Toolbar (I²C setup)

Waveform

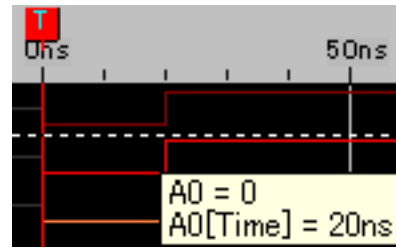

The tooltip on the status bar (the bottom left side of the display) is always On.

FAQ

The USB is slow, though the PC is USB 2.0 compatible.

Make sure the cable is compatible with 2.0 high speed (use the attached one).

The message “Hardware connection failed” pops up.

Make sure GLA is powered up and pressing the Retry button.

Disconnect/reconnect USB cable.

Do not use extension cable for USB. Make sure GLA and PC are connected by a single USB cable.

GLA does not capture signal, or the result is inaccurate.

Check all signal connections, including the ground terminal, are secure. Use both 2 GND cables for stable ground connection. Make the distance between GLA and device under test as short as possible.

The sampling rate has to be more than four times that of the signal frequency.

Regarding trigger: Make sure the trigger threshold matches the signal settings. Trigger counter and trigger page should not be too large.

If the external clock is used, the clock rate might be too low, especially if the internal clock captures signals.

A large portion of the input signal is irrelevant and consumes memory.

Use the Enable function to set a specific signal condition that triggers data capturing. In this way, you will not waste too much memory for irrelevant data. See page57 for details.

A large amount of data (more than 32Mbit) is required.

Use the Data compression feature. It uses lossless compression technique so there will be no data loss. See page42 for details.

Trigger condition does not occur.

Make sure trigger threshold matches signal setting. If the trigger condition is too complex, simplify the setting to make it easier for data capturing.

Sampling frequency of the input signal is very low.

Try using the external clock so that the acquiring period is extended. Here is the frequency range for internal and external clock.

Internal: 100Hz ~ 200MHz

External: 0.001Hz ~ 150MHz

If there is still a problem, please contact your local dealer or GWInstek at www.gwinstek.com.tw / marketing@goodwill.com.tw.

Specification

The specifications apply under the following conditions: GLA is powered on for at least 30 minutes, within +20°C~+30°C.

		GLA-1016	GLA-1032	GLA-1132
Channels		16	32	32
Memory Total/ Per Channel		4Mbits/ 256kbits	4Mbits/ 128kbits	32Mbits/ 1Mbits
Interface		USB 2.0(1.1)	USB 2.0(1.1)	USB 2.0(1.1)
Operating System		Windows XP/ Windows 7/ Windows Vista	Windows XP/ Windows 7/ Windows Vista	Windows XP/ Windows 7/ Windows Vista
Bandwidth		100MHz	100MHz	100MHz
Clock	Internal	100MHz ~ 200MHz, asynchronous	100MHz ~ 200MHz, asynchronous	100MHz ~ 200MHz, asynchronous
	External	0.001Hz ~ 100MHz, synchronous	0.001Hz ~ 100MHz, synchronous	0.001Hz ~ 100MHz, synchronous
Trigger	Channel	16	32	32
	Condition	Edge/Pattern	Edge/Pattern	Edge/Pattern
	Pre/Post trigger	0% ~ 100%	0% ~ 100%	0% ~ 100%
	Level	1	1	1
	Threshold	+6V ~ -6V	+6V ~ -6V	+6V ~ -6V
	Accuracy	±93mV	±93mV	±93mV
	Count	1 ~ 65535	1 ~ 65535	1 ~ 65535
	Page	Maximum 8191	Maximum 8191	Maximum 8191
Input	Maximum Input Voltage	±30V	±30V	±30V
	Impedance	500kΩ/10pF	500kΩ/10pF	500kΩ/10pF

Specification (cont.)

The specifications apply under the following conditions: GLA is powered on for at least 30 minutes, within +20°C~+30°C.

		GLA-1016	GLA-1032	GLA-1132
Enable	Channel	16	32	32
	Enable Condition	Don't care, Low, High	Don't care, Low, High	Don't care, Low, High
	Enable Delay	1 ~ 65535ms	1 ~ 65535ms	1 ~ 65535ms
	Skew	<1.5ns	<1.5ns	<1.5ns
Data	Compression Channels	16	24	24
	Compression Ratio	Maximum 255	Maximum 255	Maximum 255
	Signal Statistics	Positive/Negative, Full cycle within length condition	Positive/Negative, Full cycle within length condition	Positive/Negative, Full cycle within length condition
	Protocol Analyzer	I2C, RS-232C	I2C, RS-232C	I2C, RS-232C
	Static	Maximum 200mA	Maximum 200mA	Maximum 200mA
Current Consumption	Working	Maximum 400mA	Maximum 400mA	Maximum 400mA
	Static	Maximum 1W	Maximum 1W	Maximum 1W
Power dissipation	Working	Maximum 2W	Maximum 2W	Maximum 2W
	Interface	USB	USB	USB
Power	Working voltage	4.5V ~ 5.5V	4.5V ~ 5.5V	4.5V ~ 5.5V
	Operating	0°C ~ 50°C	0°C ~ 50°C	0°C ~ 50°C
Temperature	Storage	-40°C ~ 80°C	-40°C ~ 80°C	-40°C ~ 80°C

Index

A	
analysis	
I2C	90
number of cycles	97
range setup	89
RS-232	94
B	
bar	
icon overview.....	13
move bar.....	79
place after search.....	84, 86
setup	77
shortcuts.....	17
bus/signal	
sampling setup.....	40
shortcuts.....	16
C	
cleaning GLA.....	5
color	
setup	71
cursor	82
D	
data	
analysis range.....	89
compression setup	42
search	83
selective capturing.....	57
specification	107
data compression	
bar.....	14
icon overview.....	12
data operation	
shortcuts	17
demonstration mode.....	27
display	
color.....	71
grid.....	68
show all.....	88
E	
extension module connection.....	10
external clock	
input terminal	10
specification.....	107
external clock input	
setup.....	41
F	
faq.....	105
feature list.....	7
file operation	
icon overview	12
open/close.....	30
print	36
save	32
shortcuts	16, 19
functionality check	28
G	
GLA lineup.....	7
ground	
faq	105
location.....	10
H	
hardware	

faq	105	enclose mode	88
help		power	
shortcuts	19	power up sequence	26
tooltip	103	switch location	9
horizontal			
bar overview	14		
icon overview	13		
manual range setting	88		
setup	65		
		<i>R</i>	
<i>I</i>		RS-232	
I2C		analysis	94
analysis	90	icon overview	14
icon overview	14	range	89
range	89	shortcuts	18
shortcuts	18	run/stop	
icon		icon overview	12
list	16	repetitive run	74
input connector	10	shortcuts	17
		single run	74
		stop	75
		switch location	9
		<i>S</i>	
		sampling	
<i>K</i>		icon overview	12
keyboard shortcut	16	search	83
setup	100	bus	85
		icon overview	13
<i>L</i>		signal edge	
LED location	9	icon overview	13
		signal/bus	
<i>M</i>		add/delete	43
menu		software	
list	16	activation	26
menu overview	11	automatic update	102
mouse		hardware requirement	21
icon overview	13	installation	22
		overview	11
<i>O</i>		uninstallation	25
operation environment	5	version	102
		statistics	
<i>P</i>		bus search result	86
package contents	8		
panel description	9		
pointer			

storage environment.....	5		
T		V	
table of contents	3	vertical	
toolbar		bar height icon.....	14
icon overview.....	12	setup.....	66
setup	63	W	
trigger		waveform	
bus condition setup.....	51	color.....	72
conditional triggering	57	cycle analysis.....	97
delay	54	direction setup.....	67
faq.....	106	display mode icon	13
icon overview.....	12, 13, 14	move waveform	81
level	53	sawtooth/square	69
pre-triggering data	56	timing icon.....	14
shortcuts.....	17	view shortcuts	19
signal condition setup	48	Z	
specification	107	zoom	
trigger output.....	61	icon overview	13
U		in 87	
USB		manually.....	88
connector location.....	9	out	87
faq.....	105	shortcuts	17
specification	107	undo	87
warning	9		