

Digital Storage Oscilloscope

GDS-3000 Series

SERIAL DECODE MANUAL

GW INSTEK PART NO. 82DS-SBD00U01



ISO-9001 CERTIFIED MANUFACTURER

GW INSTEK

October 2010

This manual contains proprietary information, which is protected by copyright. All rights are reserved. No part of this manual may be photocopied, reproduced or translated to another language without prior written consent of Good Will company.

The information in this manual was correct at the time of printing. However, Good Will continues to improve products and reserves the rights to change specification, equipment, and maintenance procedures at any time without notice.

Good Will Instrument Co., Ltd.
No. 7-1, Jhongsing Rd., Tucheng City, Taipei County 236, Taiwan.

Table of Contents

GETTING STARTED	5
Activating Optional Software	6
QUICK REFERENCE	8
Menu Tree / Operation Shortcuts	9
MEASUREMENT	12
Serial Bus	13
INDEX	29

GETTING STARTED

This chapter describes how to install the serial decode software.



Activating Optional Software	6
---	----------

Activating Optional Software

Background The GDS-3000 has Power Analysis software, Serial bus decoding software (page 13) as well as other GW Instek software packages as optional extras. An activation key is required to activate the software. An activation key is required for each optional software package.

For the latest files and information regarding the optional software packages, see the GW Instek website: www.gwinstek.com

Activation key filenames Serial bus decode XX.LIS
activation key

Steps

1. Insert a USB stick into the front panel USB port with the activation keys located in the root directory.

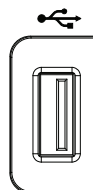

2. Press the *Utility* key.



3. Press *File Utilities* from the bottom menu.



4. The file system appears.



5. Use the Variable knob and Select key to select the activation key from the USB root directory. When prompted to continue, press the *Select* key again.

Files: XX.LIS

Confirm
Activation key

Press *B1* on the front panel to see if the Serial Bus decode activation worked.



QUICK REFERENCE

This chapter depicts the serial bus menu tree. Use them as a handy reference to get quick access to the functionality.

Menu Tree / Operation Shortcuts	9
BUS – UART.....	9
BUS – I ² C.....	9
BUS – SPI (4 channel models only)	10
Trigger Bus Menu – I ² C.....	10
Trigger Bus Menu – UART.....	11
Trigger Bus Menu – SPI (4 channel models only).....	11

Menu Tree / Operation Shortcuts

BUS – UART

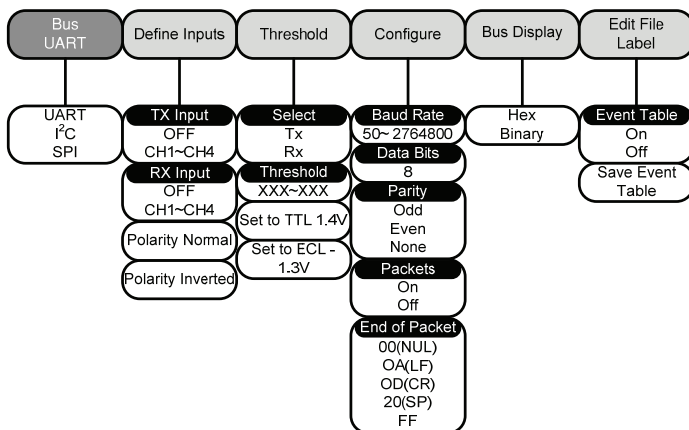

BUS – I²C

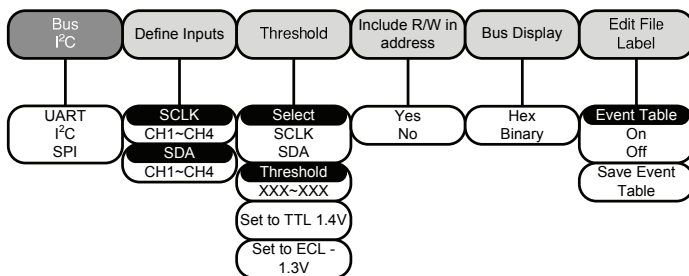

BUS – SPI (4 channel models only)

B1

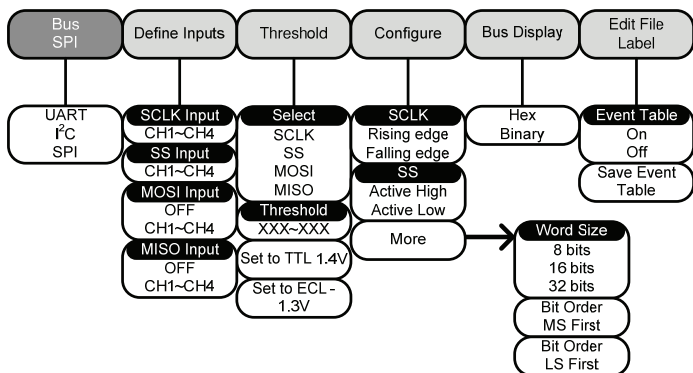

Trigger Bus Menu – I²C

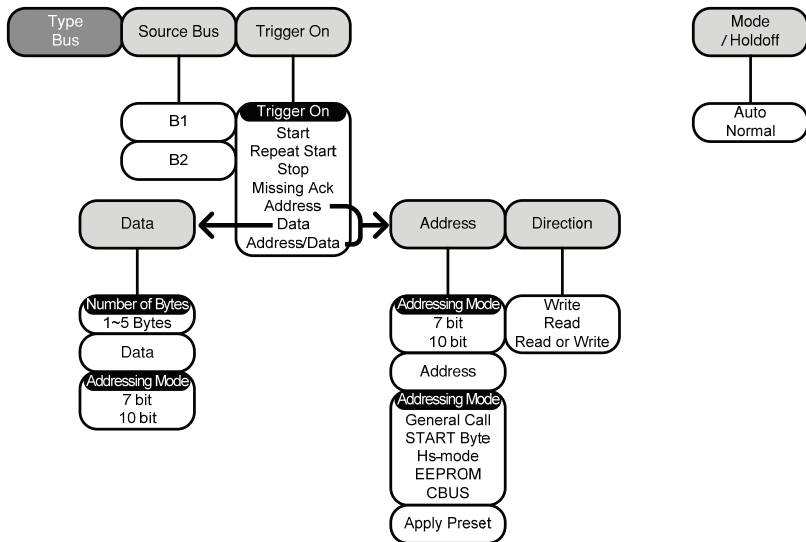

Trigger Bus Menu – UART

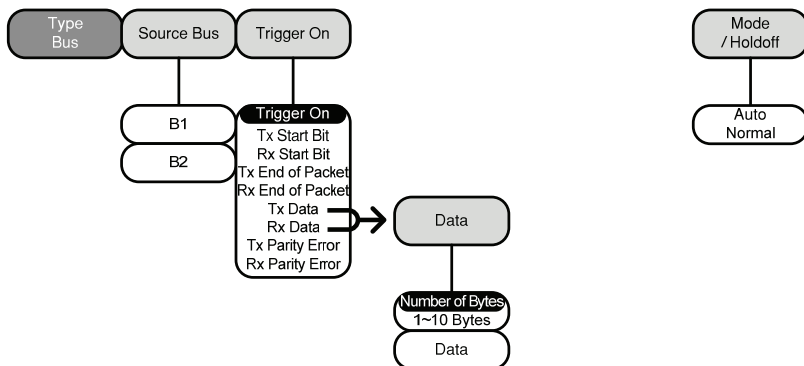

Trigger Bus Menu – SPI (4 channel models only)

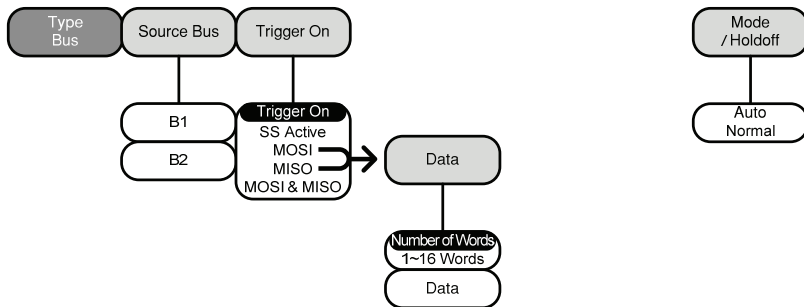

M EASUREMENT

Serial Bus.....	13
Serial Bus Overview.....	13
Serial Decode Display.....	15
Bus Trigger Settings.....	16
Serial Bus Event Tables.....	19
UART Serial Bus Interface.....	20
I ² C Serial Bus Interface.....	23
SPI Serial Bus Interface.....	26

Serial Bus

The serial bus trigger and decode software includes support for 3 common serial interfaces: SPI (4 channel models only), UART and I²C. Each interface is fully configurable to accommodate a wide range of protocol variation.

Each input can be displayed as binary or hexadecimal. An event table can also be created to aid in debugging.

Note that the Serial bus trigger and decode software is an optional extra. An activation key is required to activate the software. For details, please see page 6.

Serial Bus Overview

UART	<p>Universal Asynchronous Receiver Transmitter. The UART bus is able to accommodate a wide range of various common UART serial communications.</p> <p>The UART serial bus software is suitable for a number of RS-232 protocol variants.</p> <p>Inputs Tx, Rx</p> <p>Threshold Tx, Rx</p> <p>Configuration Baud rate, Data bits, Parity, Packets, End of packets, Input polarity</p> <p>Trigger On Tx Start Bit, Rx Start Bit, Tx End of Packet, Rx End of Packet, Tx Data, Rx Data, Tx Parity Error, Rx Parity Error</p>
I ² C	<p>Inter Integrated Circuit is a two line serial data interface with a serial data line (SDA) and serial clock line (SCLK). The R/W bit can be configured.</p> <p>Inputs SCLK, SDA</p> <p>Threshold SCLK, SDA</p>

Configuration	Addressing mode, Read/Write in address
Trigger On	Start, Repeat Start, Stop, Missing Ack, Address, Data, Address/Data





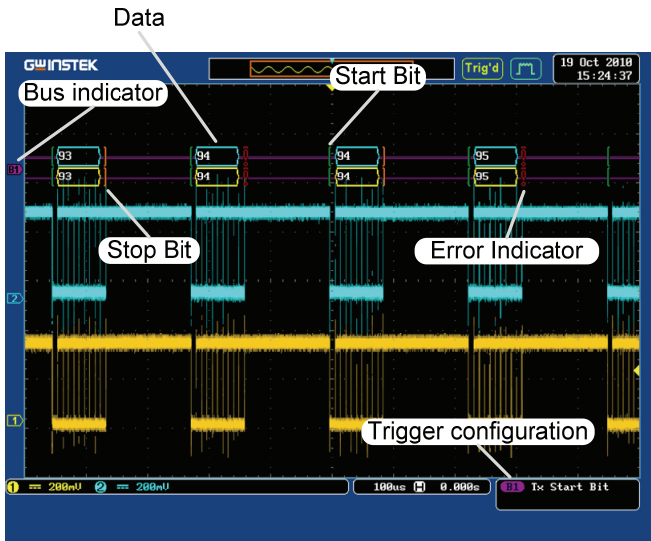

SPI

The SPI (Serial Interface Peripheral) bus is fully configurable to accommodate the wide variety of SPI interfaces. This bus is only available on 4 channel models.

Inputs	SCLK, SS, MOSI, MISO
Threshold	SCLK, SS, MOSI, MISO
Configuration	SCLK edge, SS logic level, Word size, Bit order
Trigger On	SS Active, MOSI, MISO, MOSI&MISO

Serial Decode Display



- Start Bit  The Start bit is shown as a green bracket.
- Stop Bit  The Stop bit is shown as an orange bracket.
- Data  Data packets can be shown in Hex or Binary. The color of the packet is the same as the channel color.
- Error Indicator  If there is an error in decoding the serial data, an error indicator will be shown.
- Bus Indicator The Bus indicator shows the bus position. The active bus is shown with a solid color. The Variable knob can be used to horizontally position the Bus indicator when it is active.
 -  Active bus (B1)
 -  Activated bus (B1)
- Trigger Configuration Shows the bus trigger (B1/B2) and the *Trigger On* settings.

B1 Tx Start Bit

Bus Trigger Settings

The bus trigger conditions should be set at any time after *UART*, *I²C* or *SPI* have been selected as the B1 or B2 buses. If the trigger is not set to *Bus* the trigger will not be stable.

- Panel Operation 1. Press the trigger *Menu* key and press *Type* from the bottom menu.

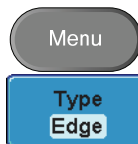

2. Press *Others* from the side menu and select *Bus*.



3. Press *Source Bus* from the bottom menu and select the source bus, *B1* or *B2*. The B1/B2 trigger appear at the bottom of the display.

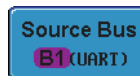

B1 Tx Start Bit

From left: Bus, Trigger On.

4. Press *Trigger On* and select the triggering condition for the selected bus.

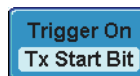

UART	Tx Start Bit, Rx Start Bit, Tx End of Packet, Rx End of Packet, Tx Data, Rx Data, Tx Parity Error, Rx Parity Error
I ² C	Start, Repeat Start, Stop, Missing Ack, Address, Data, Address/Data
SPI	SS Active, MOSI, MISO, MOSI&MISO

Trigger On - Data

If Data was configured for the Trigger On setting, then the number of bytes, data and addressing mode (I²C) can be configured.

1. If *Trigger On* was configured to *Data**, press *Data* from the bottom menu.



*The applicable *Trigger On* settings are shown below.

UART	Tx Data, Rx Data
I ² C	Data, Address/Data
SPI	MOSI, MISO, MOSI&MISO

2. Press *Number of Words/Number of Bytes* from the side menu and choose data length.

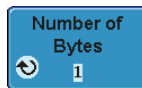

UART	1~10 Bytes
I ² C	1~5 Bytes
SPI	1~16 Words

3. If I²C is the bus type, press *Addressing Mode* to toggle between 7 and 10 bit addressing modes.

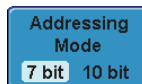

4. Press *Data* (I²C, UART) or *MOSI/MISO* (SPI) from the side menu to edit the triggering data.

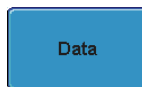

OR



To edit the data, use the *Variable* knob to highlight a binary or hex digit and press *Select*. Use the *Variable* knob to choose a value for the digit and press *Select* to confirm.

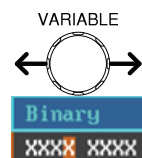

Binary	0,1,X (don't care)
Hex	0~F, X (don't care)

Trigger On -
Address

If Address was configured for the Trigger On setting, then the triggering address/addresses must be configured.

1. If *Trigger On* was configured to *Address* or *Address/Data* (I²C), press *Address* on the bottom menu.



2. Press *Addressing Mode* to toggle between 7 and 10 bit addressing modes.

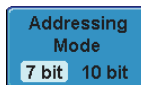

3. To choose a preset address as the default address, press *Choose Preset*.

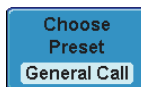

Address	Description
0000 000 0	General Call
0000 000 1	START Byte
0000 1XX X	Hs-mode
1010 XXX X	EEPROM
0000 001 X	CBUS

4. Press *Apply Preset* to set the default address to the preset.



Note

- Presets are not available for *Trigger On Address/Data*.

5. Press *Address* from the side menu to manually edit the triggering address.



To edit the address, use the

Variable knob to highlight a binary or hex digit and press *Select*. Use the *Variable* knob to choose a value for the digit and press *Select* to confirm.

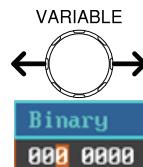

Binary 0,1, X (don't care)

Hex 0~F, X (don't care)

Direction 6. Press *Direction* on the bottom menu and choose the direction from the side menu.



Direction Write, Read, Read or Write

Serial Bus Event Tables

Each serial bus type (UART, I²C, SPI) can have an event table saved containing each bus event as a .CSV file. An event is defined as the data on the bus when a Stop or End of Packet (UART) is encountered. The data associated with each event and the time of each event is recorded.

File Type Each event table is saved as Event_TableXXXX.CSV into the designated file path. Each event table is numbered sequentially from 0000 to 9999. For example the first event table will be saved as Event_Table0000.CSV, the second as Event_Table0001.CSV, and so on.

Event Table Data Each event table saves a timestamp of each event relative to the trigger as well as the data in each frame/packet at the time of an event. The frame/packet data is saved in HEX format.

The table below lists in order the data saved for each event table.

UART Time, Tx frame data, Rx frame data, Errors.

I ² C	Time, Repeat Start, Address, Data, Missing Ack.
SPI	Time, MISO frame data, MOSI frame data.

Example Below shows the data associated with an SPI event table in a spreadsheet.

Time	MOSI	MISO
-11.60us	0D87	0D87
-10.16us	06C0	06C0
-8.720us	8343	343
-7.282us	243	243
-5.840us	0C88	0C88

UART Serial Bus Interface

The UART serial bus software is designed to decode RS232 and other common RS-232 variants such as RS-422, RS-485. The software configuration is also flexible enough to decode the many proprietary protocols based on RS-232.

Background Basic RS-232 protocol uses single-ended data transmissions. The signal voltage levels can be high ($\pm 15V$) and employ active low signaling.

High speed variants of RS-232, such as RS-422 and RS-485 use differential signaling and commonly employ low voltage differential signals with active high signaling.

Universal Asynchronous Receiver / Transmitter (UART) or RS-232 driver/receiver ICs commonly used for embedded applications typically use active high signaling with standard IC signal levels.

Panel operation 1. Insert each of the bus signals (T_x , R_x) to one of the oscilloscope channels.

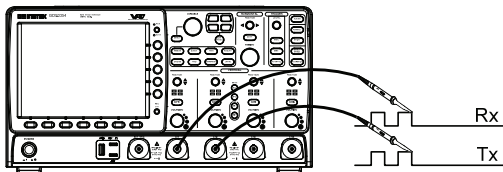

2. Choose Bus 1 or Bus 2 by pressing the corresponding bus key, *B1* or *B2*. 

3. Press *Bus* from the bottom menu and choose the *UART* serial bus on the side menu. 

Define Inputs

1. Press *Define Inputs* from the bottom menu. 

2. From the side menu choose the *Tx Input* and the *Rx Input* source and the signal polarity.

Tx OFF, CH1~4

Rx OFF, CH1~4

Polarity Normal (High = 0), Inverted (High = 1)

Set the Threshold

1. Press *Threshold* from the bottom menu. 

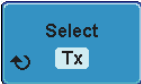
2. Press *Select* from the side menu. Choose Tx or Rx line thresholds. 

Range Tx, Rx

3. Press *Threshold* from the side menu and configure the threshold.
Logic 0 < threshold < logic 1

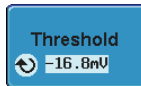

To set to TTL levels (1.4V), press TTL.

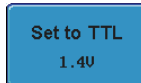

To set to ECL levels (-1.3V), press ECL.



Configuration

The Configure key sets the baud rate, number of data bits and parity.

1. Press *Configure* from the bottom menu.

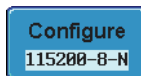

2. From the side menu select the *Baud rate*, *Data bits*, *Parity*, *Packets* and *End of Packet bits*.

Baud Rate 50, 75, 110, 134, 150, 300, 600, 1200, 1800, 2000, 2400, 3600, 4800, 7200, 9600, 14400, 15200, 19200, 28800, 31250, 38400, 56000, 57600, 76800, 115200, 128000, 230400, 460800, 921600, 1382400, 1843200, 2764800

Data Bits 8 (fixed)

Parity Odd, Even, None

Packets On, Off

End of Packet (Hex) 00(NUL), 0A(LF), 0D(CR), 20(SP), FF

Bus Display Press *Bus Display* from the bottom menu and Hex or Binary from the side menu. 

Range Hex, Binary

Event Table 1. Press *Event Table* from the bottom menu. 

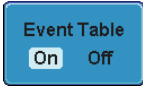
2. Press *Event Table* from the side menu to turn the event table On or Off. 

Event On, Off

3. To save the event table, press *Save Event Table*. 

Use the variable knob to scroll through the event table.

I²C Serial Bus Interface

The I²C bus is a 2 wire interface with a serial data line (SDA) and serial clock line (SCLK). The I²C protocol supports 7 or 10 bit addressing and multiple masters. The decode software will trigger on any of the following conditions: a start/stop condition, a restart, a missing acknowledge message, Address, Data or Address& Data frames. The I²C trigger can be configured for 7 or 10 bit addressing with the option to ignore the R/W bit as well as triggering on a data value or a specific address and direction (read or write or both).

Panel operation 1. Insert each of the bus signals (*SCLK*, *SDA*) to one of the oscilloscope channels.

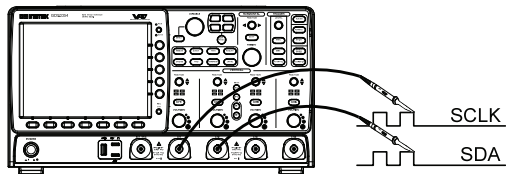

2. Press the corresponding bus key, *B1* or *B2*. 

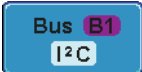
3. Press *Bus* from the bottom menu and choose *I²C* from the side menu. 

Define Inputs

1. Press *Define Inputs* from the lower menu. 

2. From the side menu choose the *SCLK* input and the *SDA* Input.

SCLK CH1~4

SDA CH1~4

3. Choose the Addressing Mode.

Mode 7 bit, 10 bit

Set the Threshold

1. Press *Threshold* from the bottom menu. 

2. From the side menu Press *Select* to choose *SCLK* or *SDA* thresholds. 

Range SCLK, SDA

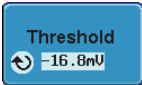
3. Press *Threshold* from the side menu and configure the threshold. 

To set to TTL levels (1.4V), press *Set to TTL*.

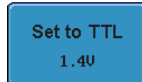

To set to ECL levels (-1.3V), press *Set to ECL*.



Include R/W in address

1. Press *Include R/W in address* from the bottom menu.



2. From the side menu select Yes or No.

R/W in Address Yes, No

Bus Display

1. Press *Bus Display* from the bottom menu.



2. Choose to display Hex or Binary data on screen.

Range Hex, Binary

Event Table

1. Press *Event Table* from the bottom menu.



2. Press *Event Table* from the side menu to turn the event table On or Off.

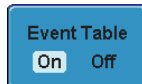

Event On, Off

3. To save the event table, press *Save Event Table*.



SPI Serial Bus Interface

The serial peripheral interface (SPI) is a full duplex 4 wire synchronous serial interface. The 4 signals lines: Serial clock line (SCLK), slave select (SS), Master output/slave input (MOSI, or SIMO) and the Master input/slave output (MISO, or SOMI). The word size is configurable from 8, 16 or 32 bits. The SPI triggers on the data pattern at the start of each framing period. This bus is only available on 4 channel models.

- Panel operation
1. Insert each of the bus signals (*SCLK*, *SS*, *MOSI*, *MISO*) to one of the oscilloscope channels.

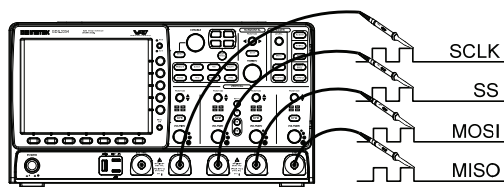

2. Choose Bus 1 or Bus 2 by pressing the corresponding bus key, *B1* or *B2*.



Note

- The SPI bus decoding function is only available on 4 channel DSO models.

3. Press *Bus* from the bottom menu and choose the *SPI* serial bus.

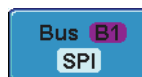

Define Inputs

1. Press *Define Inputs* from the lower menu.

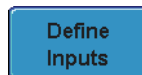

2. From the side menu choose the *SCLK*, *SS*, *MOSI* and *MISO* inputs.

SCLK CH1~4

SS CH1~4

MOSI OFF, CH1~4

MISO OFF, CH1~4

Set the Threshold 1. Press *Threshold* from the bottom menu.



2. Press *Select* from the side menu. Choose SCLK, SS, MOSI or MISO line thresholds.



Range SCLK, SS, MOSI, MISO

3. Press *Threshold* from the side menu and configure the threshold.

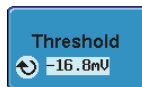

To set to TTL levels (1.4V), press *Set to TTL*.

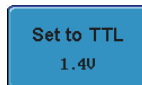

To set to ECL levels (-1.3V), press *Set to ECL*.

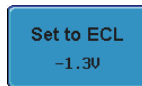



Configuration The *Configure* menu sets the data line logic level, SCLK edge polarity, word size and bit order.

1. Press *Configure* from the bottom menu.



2. From the side menu select SCLK edge, SS logic level, word Size and Bit order.

SCLK rising edge , falling edge 

SS Active High, Active Low

Word Size 8 bits, 16 bits, 32 bits

Bit Order MS First, LS First

Bus Display Press Bus Display from the bottom menu and Hex or Binary from the side menu. 

Range Hex, Binary

Event Table 1. Press *Event Table* from the bottom menu. 

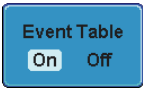
2. Press *Event Table* from the side menu to toggle the event table On or Off. 

Event On, Off

3. To save the event table, press *Save Event Table*. 

INDEX

Activation keys	6	PC.....	23
Display		overview	13
diagram	15	SPI	26
Event table	19	UART.....	20
Optional software		Software activation	6
activation	6	Trigger Settings	16
Serial Bus	13		