

DIGITAL MULTIMETER

MODEL: GDM-8135



82DM-81350MI

SECTION	TITLE	PAGE	SECTION	TITLE	PAGE
1.	INTRODUCTION AND SPECIFICATIONS	1	4.	MAINTENANCE	12
1-1	Description	1	4-1	Introduction	12
1-2	Specifications	2	4-2	Service Information	13
1-3	Outline Drawing	5	4-3	General Maintenance	13
2.	OPERATING INSTRUCTIONS	6	4-4	Access	13
2-1	Introduction	6	4-5	Cleaning	13
2-2	Input Power	6	4-6	Fuse Replacement	13
2-3	Operating Features	6	4-7	Performance Checks	13
2-4	Input Connections	8	4-8	Environmental Conditions	13
2-5	Overload Protection	8	4-9	"Zero" Checks	14
2-6	Basic Instrument Measurement	8	4-10	Normal Mode Rejection Check	14
3.	THEORY OF OPERATION	10	4-11	Accuracy Checks	14
3-1	Introduction	10	4-12	Calibration	14
3-2	Block Diagram Analysis	10	4-13	Environmental Conditions	14
3-3	Introduction	10	4-14	"Zero" Checks	14
3-4	Signal Conditioning	10	4-15	Normal Mode Rejection Adjustment	15
3-5	Analog-to-Digital Converter	10	4-16	Range Adjustments	16
3-6	Display	10			

SECTION 1

INTRODUCTION & SPECIFICATIONS

1-1. DESCRIPTION

The instrument is a compact, light weight with a three and one-half digit multimeter. A unique analog-to-digital conversion technique, with inherent self zeroing, eliminates offset uncertainties. Two LSI chips comprise the analog-to-digital converter allowing a reduction of the discrete electrical component count to less than 110. Other features include automatic digital determination of polarity, Continuous filtering, and LED readouts.

Pushbutton controls allow the selection of five ac and dc voltage ranges, six ac and dc current ranges, and six resistance ranges. Accurate measurement capabilities are from 100 microvolts to 1000 volts dc and 1000 ac, 100 nanoamperes to 19.99 amperes ac and dc, and 100 milliohms to 19.99 megohms.

1-2. SPECIFICATIONS

DC Voltage

Ranges $\pm 199.9\text{mV}$, $\pm 1.999\text{V}$, $\pm 19.99\text{V}$, $\pm 199.9\text{V}$ $\pm 1199\text{V}$

Accuracy:

1 year, 15°C to 35°C $\pm(0.1\%$ of reading + 1 digit)

Input Impedance 10 Megohms, all ranges

Normal Mode Rejection Greater than 60db @ 50Hz, 60Hz

Common Mode Rejection Greater than 120db @ dc and 50Hz, 60Hz
(1k Ω unbalance)

Response Time 1/2 second

Maximum Input Voltage 1000V rms, all ranges

AC Voltage

Ranges 199.9mV, 1.999V, 19.99V, 199.9V, 1000V

Accuracy:	All ranges:	40Hz to 1kHz $\pm(0.5\% + 1 \text{ digit})$
1 year, 15°C to 35°C	200mV~200V ranges:	1kHz to 10kHz $\pm(1\% + \text{digit})$
	200mV~20V ranges:	10kHz to 20kHz $\pm(2\% + 1 \text{ digit})$
	200mV~20V ranges:	20kHz to 40kHz $\pm(5\% + 1 \text{ digit})$
Input Impedance	10 megohms in parallel with 100pf	
Common Mode Rejection (1 k Ω unbalance)	Greater than 60 db @ 50Hz, 60Hz	
Response Time	3 seconds, worst case	
Maximum Input Voltage	1000V rms, not to exceed 10 ⁷ volt Hz product on 20, 200, 1000V ranges, 750V rms on 200mV and 2V ranges.	

DC Current

Ranges $\pm 199.9\mu\text{A}, \pm 1.999\text{mA}, \pm 19.99\text{mA}, \pm 199.9\text{mA}, \pm 1.999\text{A}, \pm 19.99\text{A}$

Accuracy:
1 year, 15°C to 35°C $\pm(0.2\% \text{ of reading} + 1 \text{ digit})$ except 2000mA 20.00A range.
 $\pm(0.5\% \text{ of reading} + 1 \text{ digit})$ 2000mA, 20.00A range.

Voltage Burden 0.22V maximum up to 2 Amps

Response Time 1/2 second

Maximum Input 2A input 2 Amps rms (fuse protected)
20A input 20 Amps rms (no fuse)

AC Current

Ranges 199.9 μA , 1.999mA, 19.99mA, 199.9mA, 1999mA, 19.99A

Accuracy:
 1 year, 15°C to 35°C 40Hz to 1KHz ± (0.5% of reading + 1 digits)
 1KHz to 10KHz ± (1% + 1 digit)
 10KHz to 20KHz ± (2% + 1 digit) except 2000mA,
 20.00A range.
 40Hz to 2kHz ± (1.0% of reading + 2 digits)
 2000mA, 20.00A range.

Voltage Burden 0.22V maximum up to 2 Amp

Response Time 3 seconds

Maximum Input 2A. input 2 Amps rms (fuse protected)
 20A input 20 Amps rms (no fuse)

Resistance

Ranges 199.9Ω, 1.999kΩ, 19.99kΩ, 199.9kΩ, 1999kΩ, 19.99MΩ

Accuracy:
 1 year, 15°C to 35°C 200Ω; 2kΩ, 20kΩ, 200kΩ, 2000kΩ ranges
 ± (0.2% of reading + 1 digit)
 20MΩ range ± (0.5% of reading + 1 digit)

Response time 200Ω, 2kΩ, 20kΩ, 200kΩ, 2000kΩ ranges.
 1/2 second

20MΩ range: 4 seconds

Current through Unknown 200Ω Range 1 mA
 2kΩ Range 1mA
 20kΩ Range 100μA
 200kΩ Range 1μA
 2000kΩ Range 1μA
 20MΩ Range 0 1μA

Maximum Input Voltage 300V dc/ac rms on all ranges

Audible Continuity Check

Description	Built-in — buzzer sounds if conductance less than 10 Ω .	
Test Current	Max. 1.0 mA	
Open Voltage	Max. 13 V	
Environmental		
Operating Temp. Range	0°C to +50°C	
Storage Temp. Range	-10°C to +70°C	
Humidity Range	0 to 80%, 0°C to 35°C on 2000K Ω , 20M Ω ranges: 0 to 90%, 0°C to 35°C on all other ranges 0 to 70%, 35°C to 50°C	
General		
Max. Common Mode Voltage	1000V peak or 500V dc/ac rms.	
Display	7-segment LED, 0.5" character height	
Size	95(H) x 245(W) x 280(D) m/m	
Weight	2.5Kg	
Power	100V, 120V, 220V or 230V ac, 50 to 400Hz, 5 watt	
Accessories	Test lead	2 ea.
	Instruction manual	1 ea.

1-3. OUTLINE DRAWING

The instrument Outline Drawing is illustrated in Figure 1-1.

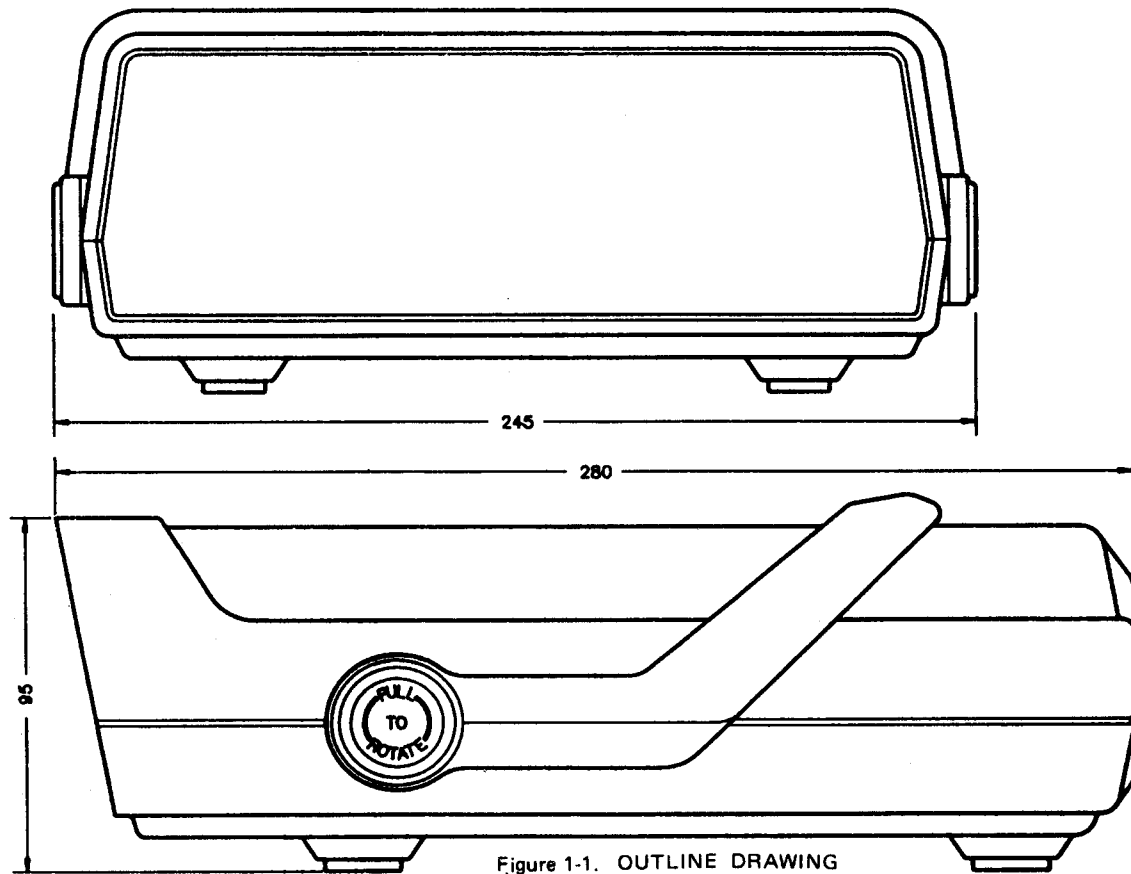

Figure 1-1. OUTLINE DRAWING

SECTION 2

OPERATING INSTRUCTIONS

2-1. INTRODUCTION

This section contains information regarding installation and operation of this instrument. The contents of this section should be read and understood before operating the digital multimeter.

2-2. INPUT POWER

The instrument are supplied with one of four ac input power configurations. AC 100V, 120V, 220V or 230V 50Hz to 400Hz.

Before connecting to ac line power, insure that the instrument is in the proper configuration for your power requirements. A decal on the rear side of the instrument indicates which ac line voltage is required.

2-3 OPERATING FEATURES

The location and function of all controls, connectors, and indicators is shown in Figure 2-1.

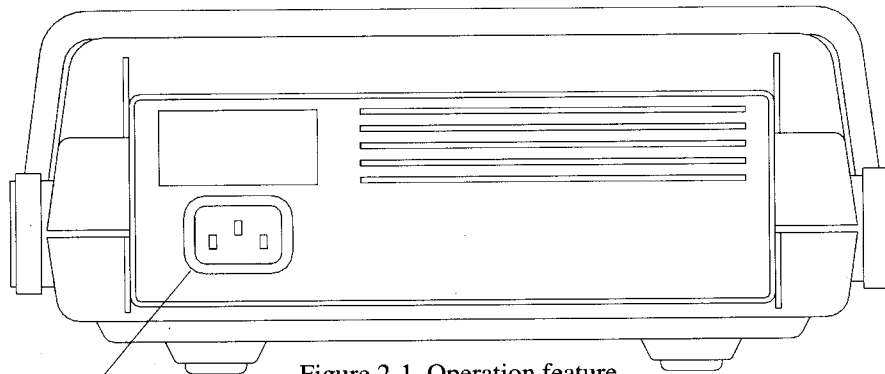
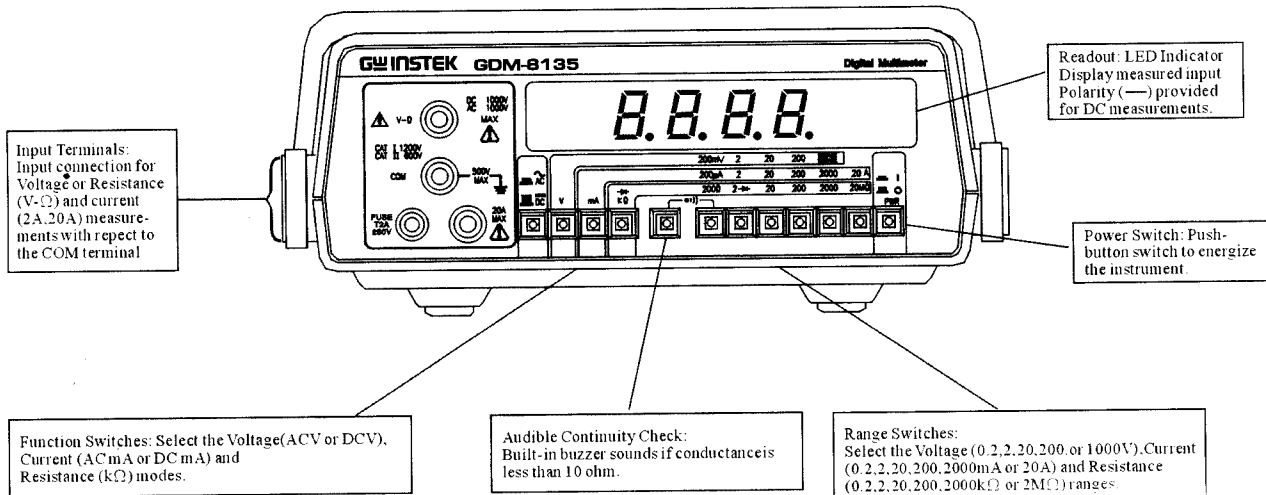

AC Socket: for connection AC cord to AC power line

Figure 2-1. Operation feature

2-4. Input Connections

Four INPUT terminals (2A, 20A, V- Ω , and COMMON) provide connection to the source or resistance under measurement. For source measurements, the 2A, 20A or V- Ω and COMMON terminals connect to the respective high and low sides of the source. An unknown resistance is connected between the V- Ω and COMMON terminals.

2-5. Overload Protection

An overload condition is indicated by the simultaneous flashing of the display readouts. The dc voltage function can sustain up to 1000 volts rms between the V- Ω and COMMON terminals on any range. The ac voltage function can sustain up to 1000 volts rms (not to exceed 10^7 volt hertz) on the 20, 200, and 1000 volt ranges and 750 volts rms on the 200 millivolt and 2 volt ranges between the V- Ω and COMMON terminals. The current input is fuse protected above 2 amperes rms with a maximum of 2 volts rms between the 2A, and COMMON terminals; the 20A and com terminals are used for signal input. The 20A input terminal is labeled to remind the operator that the maximum current measured between these two terminals is 20A and that the function is not fuse protected. Protection for the resistance function is to 300 volts rms between the V- Ω and COMMON terminals.

2-6. BASIC INSTRUMENT MEASUREMENT

Measurement instructions for the basic instrument (less Option-02 and accessories) are provided in Table 2-1.

Table -2-1. BASIC MEASUREMENT INSTRUCTIONS

MEASUREMENT	FUNCTION	RANGE	INPUT CONNECTION	REMARKS
DC Volts	DCV	200mV, 2, 20, 200, or 1000V	V- Ω and COMMON	Auto-polarity
DC Milliamperes	DC mA	200 μ A, 2, 20 200 or 2000mA	2A and COMMON	
		20A	20A and COMMON	
AC Volts	ACV	200mV, 2, 20 200, or 1000V	V- Ω and COMMON	
AC Milliamperes	AC mA	200 μ A, 2, 20 200 or 2000 mA	2A and COMMON	
		20A	20A and COMMON	
Kilohms	K Ω	200 Ω , 2, 20 200, 2000K Ω , 20M Ω	V- Ω and COMMON	

SECTION 3

THEORY OF OPERATION

3-1. INTRODUCTION

Information about this instrument theory of operation is arranged under the major headings. The heading is titled **BLOCK DIAGRAM ANALYSIS**. Discussion at the block diagram level consists of the overall operation of the major circuits within the instrument.

Block diagrams are included in this section. Schematic diagrams are located at the rear of this manual.

3-2. BLOCK DIAGRAM ANALYSIS

3-3. Introduction

Note in the block diagram, Figure 3-1, that the toned areas divide the instrument into three major sections. These sections, Signal Conditioning, Analog-to-Digital Converter, and Display, are discussed separately in the following paragraphs.

3-4. Signal Conditioning

The Signal Conditioning section provides a dc analog voltage, characteristic of the applied input, to the Analog-to-Digital Converter section. This task is accomplished by the Input Voltage Divider, Current Shunts, AC Converter, Ohms Converter, Active Filter, and associated switching.

3-5. Analog-to-Digital Converter

The Analog-to-Digital (A/D) Converter section changes the dc output voltage from the Signal Conditioning section to digital information. This is accomplished by a unique A/D conversion technique that eliminates zero error. Two LSI (Large Scale Integration) circuits comprise the A/D Converter. These circuits are the Analog Integrated Circuit and the Digital Integrated Circuit.

3-6. Display

Digital information from the A/D Converter section is decoded and visually presented by the Display section. The decoded digital information is displayed on numerical LED (Light Emitting Diode) readouts. Decoding of the digital information is accomplished by the Polarity, Decoder Driver, and Anode Control Circuits.

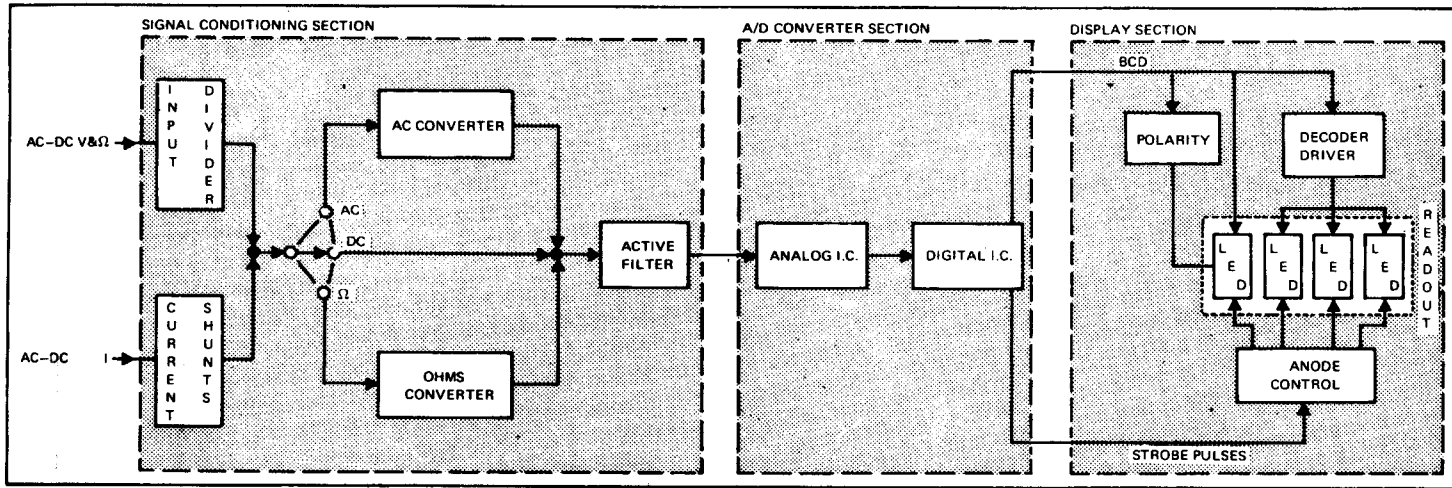

Figure 3-1. BLOCK DIAGRAM

SECTION 4 MAINTENANCE

4-1. INTRODUCTION

This section contains information concerning preventive and corrective maintenance for this Digital Multimeter. The information is arranged under the following headings: SERVICE INFORMATION, GENERAL MAINTENANCE, PERFORMANCE TEST, and CALIBRATION PROCEDURE.

A calibration interval of one year is recommended to ensure instrument operation within the one year specifications. These specifications may be found in Section 1.

Table 4-1 lists the recommended test equipment. If this equipment is not available, other equipment having equivalent specifications may be used.

Table 4-1. TEST EQUIPMENT

EQUIPMENT NOMENCLATURE	USE	SPECIFICATIONS	RECOMMENDED EQUIPMENT
DC Voltage Source	Calibration, Performance Checks, Troubleshooting	190mV to 1000V \pm 0.03%	Fluke Model 341A
DC Current Source	Calibration, Performance Checks	190 μ A to 1.9A \pm 0.1%	Fluke Model 382A
AC Volatage Source	Calibration, Performance Checks	190mV to 1000V (45Hz to 10kHz) \pm 0.1% 190mV to 1000V (10kHz to 20kHz) \pm 0.2%	Fluke Models 5200A/5205A
AC Current Source	Performance Checks	190 μ A to 190mA (100Hz to 10kHz) \pm 0.3% 1.9A (100Hz to 3kHz) \pm 0.3%	Optimization AC 105, and Fluke Models 540B, 382A, A45, and A40 shunts (20mA, 200mA, and 2A)
Resistors	Calibration	10 Ω - 100 Ω \pm 0.06%, 1K Ω -1M Ω \pm 0.015% 10M Ω \pm 0.075%	Fluke Model 515A
Frequency Counter	Calibration	To measure positive 100 msec. pulse with 1 μ sec resolution.	Good will GUC-2010G

4-2. SERVICE INFORMATION

A unique 5 days turnaround service is provided for this instrument. Should your instrument need repair, send it to the nearest factory authorized service center.

The WARRANTY is also located at the rear of case (Ser. No.) and warrants the instrument for a period of one year.

4-3. GENERAL MAINTANENCE

4-4. Access

Use the following procedure to gain access to the Interior of the instrument.

- a. With the power switch OFF, disconnect the line cord.
- b. Remove the four screws on the side of the instrument case.
- c. Remove the upper part of the case.

CAUTION!

When soldering or desoldering on the PCB, either remove of the place a thing insulating material between a the holder contact.

4-5. Cleaning

Clean the front panel and case with denatured alcohol or a mild solution of detergent and water. Do not use aromatic hydrocarbons or chlorinated solvents because they will react with the plastic materials of the instrument.

4-6. Fuse Replacement

The input power fuse is located within the instrument in a fuse clip near the power transformer. To gain access to the fuse, refer to paragraph 4.1. When replacement is required, install (0.2A 100V/120V), (0.1A, 220V/230V) as indicated on the P.C. Board.

The current shunt protection fuse is located behind the front panel. To remove the fuse, turn the fuse holder in the direction indicated on the front panel. When replacement is required, install 2A as indicated on the front panel.

4-7. PERFORMANCE CHECKS

4-8. Environmental Conditions

The environmental conditions for conducting the performance checks are as follows.

- a. Ambient Temperature — 22° C to 25° C (72° F to 77° F)
- b. Relative Humidity — 70%

4-9. "Zero" Checks

- A. With the instrument energized, depress the DCV and 200mV pushbuttons.
- b. Short the V- Ω terminal to the COMMON terminal. The readout should indicate ≤ 1 digit.
- c. Remove the short. The readout should indicate $\leq \pm 20$ digits.

4-10. Normal Mode Rejection Check

- a. With the instrument energized by line power, depress the VDC function and 20 range pushbuttons.
- b. Apply ac power line voltage between the V- Ω and COMMON terminals.
- c. The readout should indicate 0 ± 2 digits. (If necessary, refer to paragraph 4-15, Normal Mode Rejection Adjustment.)

4-11. Accuracy Checks

The accuracy checks compare the instruments performance to the accuracy specifications listed in Section 1. Use "Table 4-3, disregarding the "ADJUSTMENT" column, since the display limits for a given input are listed. For the AC current performance checks, refer to Table 4-2, AC MA PERFORMANCE CHECKS.

4-12. CALIBRATION

4-13. Environmental Conditions

Instrument calibration should be accomplished under the following environmental conditions.

- a. Ambient Temperature — 22° C to 25° C (72° F to 77° F)
- b. Relative Humidity — 70%

4-14. "Zero" Checks

Verify that the open circuit and short circuit zero is within the limits specified in paragraph 4-9.

4-15. Normal Mode Rejection Adjustment

Refer to the Normal Mode Rejection Check in paragraph 4-10, to determine if adjustment is necessary. Should adjustment be required, use the following procedure.

Remove the upper part of the case (refer to paragraph 4-4).

Table 4-2. AC mA PERFORMANCE CHECKS

FUNCTION/RANGE	INPUT	DISPLAY LIMITS
AC mA/200 μ A	190 μ A @ 100 Hz	189.0 to 191.0
AC mA/200 μ A	190 μ A @ 10 kHz	188.0 to 192.0
AC mA/2	1.9mA @ 100 Hz	1.890 to 1.910
AC mA/2	1.9mA @ 10kHz	1.880 to 1.920
AC mA/20	19mA @ 100 Hz	18.90 to 19.10
AC mA/20	19mA @ 10 kHz	1.880 to 19.20
AC mA/200	190mA @ 100 Hz	189.0 to 191.0
AC mA/200	190mA @ 10 kHz	1.880 to 192.0
AC mA/2000 mA	1.9A @ 100Hz	1880 to 1920
AC mA/2000 mA	1.9A @ 2 kHz	1880 to 1920
AC mA/19.99A	19A @ 100Hz	18.80 to 19.20
AC mA/19.99A	19A @ 2kHz	18.80 to 19.20

4-16. Range Adjustments

Refer to Figure 4-1 for the location of the range adjustments. Table 4-3 lists the order of the adjustments and cardinal check points. Apply the inputs listed and adjust or check for in-limits indications.

TABLE 4-3 CALIBRATION

FUNCTION/ RANGE	INPUT	ADJUSTMENT	DISPLAY LIMITS	FUNCTION/ RANGE	INPUT	ADJUSTMENT	DISPLAY LIMITS
DCV/200mV	+0.19V dc	200mVDC (VR302) Adjust for +190.0	+189.7 to +190.3	DCmA/2000mA	+1.9A	VR203 Adjust for 1900	1889 to 1911
DCV/200mV	-0.19V dc	-----	-189.7 to -190.3	DCmA/20A	+19A	VR204 Adjust for 19.00	18.89 to 19.11
DCV/2V	+1.9V dc	2VDC (VR303) Adjust for +1.900	+1.897 to +1.903	ACV/2V	1.9V@400Hz	VR501 Adjust for 1.900	1.889 to 1.911
DCV/2V	-1.9V dc	-----	-1.897 to -1.903	ACV/2V	1.9V@100Hz	-----	1.889 to 1.911
DCV/20V	+19V dc	20VDC (VR201) Adjust for +19.00	+18.97 to +19.03	ACV/2V	1.9V@10KHz	-----	1.880 to 1.920
DCV/200V	+190V dc	-----	+189.7 to +190.3	ACV/200mV	190mV@400Hz	VR502 Adjust for 190.0	188.9 to 1.911
DCV/1000V	+1000V dc	1000VDC (VR205) Adjust for +1000	+998 to +1002	ACV/200mV	190mV@100Hz	-----	188.9 to 1.911
20M Ω	19M Ω	20M Ω (VR402) Adjust for 19.00	18.89 to 19.11	ACV/200mV	190mV@10KHz	-----	188.0 to 192.0
K Ω /20K Ω	19K Ω	20K Ω (VR401) Adjust for 19.00	18.95 to 19.05	ACV/20V	19V@20KHz	-----	18.61 to 19.39
K Ω /200 Ω	190 Ω	-----	189.5 to 190.5	ACV/200V	100V@10KHz	VC201 Adjust for 100.0	98.9 to 101.1
K Ω /2K Ω	1.9K Ω	-----	1.895 to 1.905	ACV/20V	19V@10KHz	VC202 Adjust for 19.00	18.80 to 19.20
K Ω /200K Ω	190K Ω	-----	189.5 to 190.5				
K Ω /2000K Ω	1900K Ω	-----	1895 to 1905				
DCmA/200 μ A	+190 μ A	-----	189.5 to 190.5	ACV/1000V	1000V@1KHz	VC201 Adjust for 1000	994 to 1006
DCmA/2mA	+1.9mA	-----	1.895 to 1.905	ACV/20V	19V@10KHz	VC203 Adjust for 19.00	18.80 to 19.20
DCmA/20mA	+19mA	-----	18.95 to 19.05	ACV/1000V	1000V@100Hz	-----	994 to 1006
DCmA/200mA	+190mA	VR202 Adjust for 190.0	189.5 to 190.5				

GDM-625A

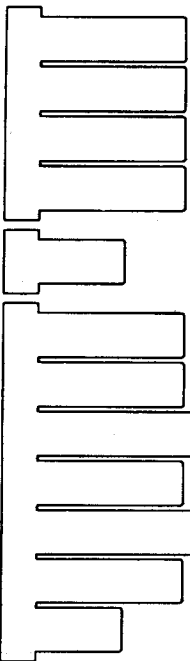
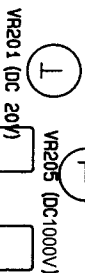
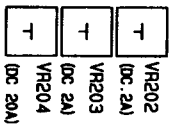
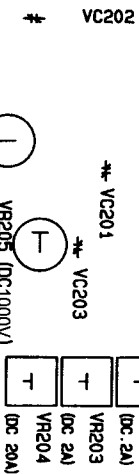
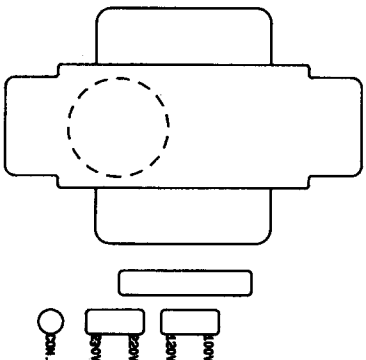
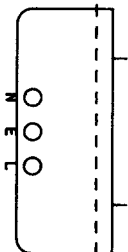
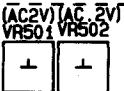
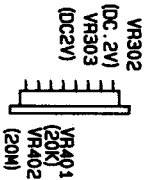

GDM-8135 (ADDITION)

1. ADD TO P4

Operation Environment

indoor use

Altitude up to 2000m

Installation Category III

Pollution Degree 2

Power Consumption

25VA, 10Watts



WARNING. To avoid electrical shock, the power cord protective grounding conductor must be connected to ground.



CAUTION. To avoid damaging the instrument, don't use it in a place where ambient temperature exceeds +50°C.

2. ADD TO P 13



WARNING. For continued fire protection. Replace fuse only with the specified type and rating, and disconnect the power cord before replacing fuse.

EC Declaration of Conformity

We

GOOD WILL INSTRUMENT CO., LTD.

No.7-1, Jhongsing Rd, Tucheng City, Taipei County 236, Taiwan

GOOD WILL INSTRUMENT (SUZHOU) CO., LTD.

No.69 Lushan Road, Suzhou New District Jiangsu, China.

declare that the below mentioned product

GDM-8135

is herewith confirmed to comply with the requirements set out in the Council Directive on the Approximation of the Law of Member States relating to Electromagnetic Compatibility (89/336/EEC, 92/31/EEC, 93/68/EEC) and Low Voltage Equipment Directive (73/23/EEC, 93/68/EEC).

For the evaluation regarding the Electromagnetic Compatibility and Low Voltage Equipment Directive, the following standards were applied:

© EMC

EN 61326-1: Electrical equipment for measurement, control and laboratory use
— EMC requirements (1997+A1: 1998)

Conducted and Radiated Emissions CISPR 22 class B: 1993	Electrostatic Discharge: IEC 1000-4-2:1995
Current Harmonic EN 61000-3-2: 1995	Radiated Immunity: IEC 1000-4-3:1995
Voltage Fluctuation EN 61000-3-3: 1995	Electrical Fast Transients: IEC 1000-4-4:1995
-----	Surge Immunity: EN 61000-4-5: 1995
-----	Conducted Susceptibility: EN 61000-4-6: 1996
-----	Power Frequency Magnetic Field: EN 61000-4-8: 1993
-----	Voltage Dips/ Interrupts: EN 61000-4-11: 1994

Low Voltage Equipment Directive 73/23/EEC

Low Voltage Directive

IEC/EN 61010-1: 2001

FOR UNITED KINGDOM ONLY

**This lead/appliance must only
be wired by competent persons**

**WARNING
THIS APPLIANCE MUST BE
EARTHED
IMPORTANT**

**The wires in this lead are
coloured in accordance with
the following code:**

**Green/
Yellow: Earth
Blue: Netural
Brown: Live(Phase)**



As the colours of the wires in main leads may not correspond with the colours marking identified in your plug/appliance, proceed as follows:

The wire which is coloured Green & Yellow must be connected to the Earth terminal marked with the letter E or by the earth symbol \perp or coloured Green or Green & Yellow.

The wire which is coloured Blue must be connected to the terminal which is marked with the letter N or coloured Blue or Black.

The wire which is coloured Brown must be connected to the terminal marked with the letter L or P or coloured Brown or Red.

If in doubt, consult the instructions provided with the equipment or contact the supplier.

This cable/appliance should be protected by a suitably rated and approved HBC mains fuse : refer to the rating information on the equipment and/or user instructions for details. As a guide, cable of 0.75mm² should be protected by a 3A or 5A fuse. Larger conductors would normally require 13A types, depending on the connection method used.

Any moulded mains connector that requires removal/replacement must be destroyed by removal of any fuse & fuse carrier and disposed of immediately, as a plug with bared wires is hazardous if engaged in a live socket. Any re-wiring must be carried out in accordance with the information detailed on this label.

SAFETY TERMS AND SYMBOLS

These terms may appear in this manual or on the product:

WARNING. Warning statements identify condition or practices that could result in injury or loss of life.

CAUTION. Caution statements identify conditions or practices that could result in damage to this product or other property.

The following symbols may appear in this manual or on the product:



DANGER
High Voltage



ATTENTION
refer to Manual



**Protective
Conductor
Terminal**



**Earth
(Ground)
Terminal**