

# 2kV DC Voltmeter

GVM-9102

---

USER MANUAL

REV. A



ISO-9001 CERTIFIED MANUFACTURER

**GW INSTEK**

This manual contains proprietary information, which is protected by copyrights. All rights are reserved. No part of this manual may be photocopied, reproduced or translated to another language without prior written consent of Good Will company.

The information in this manual was correct at the time of printing. However, Good Will continues to improve products and reserves the right to change specifications, equipment, and maintenance procedures at any time without notice.

Good Will Instrument Co., Ltd.

No. 7-1, Jhongsing Rd., Tucheng Dist., New Taipei City 236, Taiwan (R.O.C.).

# Table of Contents

<b>SAFETY INSTRUCTIONS .....</b>	<b>5</b>
Safety Symbols.....	5
Safety Guidelines .....	6
<b>GETTING STARTED.....</b>	<b>9</b>
Characteristics .....	10
Front Panel Overview .....	12
Rear Panel Overview .....	16
Status Bar.....	19
Set Up .....	23
<b>BASIC MEASUREMENT .....</b>	<b>25</b>
Basic Measurement Overview.....	26
DCV Measurement .....	28
<b>ADVANCED MEASUREMENT .....</b>	<b>33</b>
Advanced Measurement Overview.....	34
Relative Value Measurement .....	34
Trigger Setting .....	36
Filter Setting.....	41
Math Measurement .....	44
<b>DIGITAL I/O .....</b>	<b>54</b>
Digital I/O Overview .....	55
Application: Compare Mode .....	57
Application: 4094 / User Mode .....	64
Application: External Trigger .....	72
<b>SYSTEM &amp; FIRMWARE .....</b>	<b>74</b>
View System Info.....	75
Firmware Update .....	76
<b>MENU SETTING .....</b>	<b>78</b>
Configure System .....	79
Configure Display .....	96
<b>SCREENSHOT &amp; LOG .....</b>	<b>115</b>
Capture .....	116
Save Reading .....	119

<b>DISPLAY SETTING .....</b>	<b>123</b>
Digit .....	124
Display .....	126
Zero Fill .....	146
<b>REMOTE CONTROL .....</b>	<b>147</b>
Configure Interface .....	148
Web Control Interface .....	183
Command Syntax .....	188
Command Set .....	191
Status system.....	234
<b>APPENDIX .....</b>	<b>238</b>
Fuse Replacement.....	239
Battery Replacement.....	240
Factory Default Parameters .....	242
Specifications .....	245
GVM-9102 Section .....	246
Declaration of Conformity .....	248
<b>INDEX .....</b>	<b>249</b>

# S SAFETY INSTRUCTIONS

This chapter contains important safety instructions that you must follow when operating the GVM-9102 and when keeping it in storage. Read the following before any operation to ensure your safety and to keep the GVM-9102 in the best possible condition.

## Safety Symbols

These safety symbols may appear in this manual or on the GVM-9102.

---



WARNING

Warning: Identifies conditions or practices that could result in injury or loss of life.

---



CAUTION

Caution: Identifies conditions or practices that could result in damage to the GVM-9102 or to other property.

---



DANGER High Voltage

---



Attention Refer to the Manual

---



Protective Conductor Terminal

---



Earth (ground) Terminal

---



Do not dispose electronic equipment as unsorted municipal waste. Please use a separate collection facility or contact the supplier from which this instrument was purchased.

---

## Safety Guidelines

---

### General Guideline



#### CAUTION

- Make sure that the voltage input level does not exceed DC 2400 V.
- Do not place any heavy object on the instrument.
- Avoid severe impact or rough handling that can lead to damaging the instrument.
- Do not discharge static electricity to the instrument.
- Use only mating connectors, not bare wires, for the terminals.
- Do not block or obstruct the cooling fan vent opening.
- Do not perform measurement at the source of a low-voltage installation or at building installations (Note below).
- Do not disassemble the instrument unless you are qualified as service personnel.
- Make sure that the Input LO to earth is limited to 500 Vpk.

---

(Note) EN 61010-2-030 specifies the measurement categories and their requirements as follows.

- Measurement is rated for CAT 'none'.
- Measurement category IV is for measurement performed at the source of low-voltage installation.
- Measurement category III is for measurement performed in the building installation.
- Measurement category II is for measurement performed on the circuits directly connected to the low voltage installation.

### Power Supply



#### WARNING

- AC Input voltage: AC 100 V / 120 V / 220 V / 240 V  $\pm 10\%$ , 50 Hz / 60 Hz / 400 Hz  $\pm 10\%$
  - The power supply voltage should not fluctuate more than 10 %.
  - Connect the protective grounding conductor of the AC power cord to an earth ground, to avoid electrical shock.
-

Power Cord Requirement	<p>If the equipment is used in a manner not specified by the manufacturer, the protection provided by the equipment may be impaired. Do NOT replace the detachable MAINS supply cords by inadequately RATED cords.</p> <p>Suitable supply cord set for use with the equipment:</p> <ul style="list-style-type: none"> <li>▪ Mains plug: Shall be national approval</li> <li>▪ Mains connector: C13 type</li> <li>▪ Cable:             <ol style="list-style-type: none"> <li>1. Length of power supply cord: less than 3 m</li> <li>2. Cross-section of conductors: at least 0.75 mm<sup>2</sup></li> <li>3. Cord type shall meet the requirements of IEC 60227 or IEC 60245 (e.g.: H05VV-F, H05RN-F)</li> </ol> </li> </ul>
<p>Fuse</p>  <p>WARNING</p>	<ul style="list-style-type: none"> <li>• Fuse type: T 0.25 A 100 / 120 VAC T 0.125 A 220 / 240 VAC</li> <li>• Make sure the correct type of fuse is installed before power up.</li> <li>• To avoid risk of fire, replace the fuse only with the specified type and rating.</li> <li>• Disconnect the power cord before fuse replacement.</li> <li>• Make sure the cause of a fuse blowout is fixed before fuse replacement.</li> </ul>
Cleaning the Instrument	<ul style="list-style-type: none"> <li>• Disconnect the power cord before cleaning.</li> <li>• Use a soft cloth dampened in a solution of mild detergent and water. Do not spray any liquid into the GVM-9102.</li> <li>• Do not use chemicals or cleaners containing harsh material such as benzene, toluene, xylene, and acetone.</li> </ul>
Operation Environment	<ul style="list-style-type: none"> <li>• Location: Indoor, no direct sunlight, dust free, almost non-conductive pollution (Note below)</li> <li>• Temperature: Full accuracy for 0 °C to 55 °C.</li> <li>• Humidity:             <ul style="list-style-type: none"> <li>&lt; 30 °C: &lt; 80 % RH (non-condensing)</li> <li>30 °C to 40 °C: &lt; 70 % RH (non-condensing)</li> <li>&gt;40 °C: &lt; 50 % RH (non-condensing)</li> </ul> </li> <li>• Altitude: &lt; 2000 m</li> </ul>

---

(Note) EN 61010-1 specifies the pollution degrees and their requirements as follows. The GVM-9102 falls under degree 2. Pollution refers to “addition of foreign matter, solid, liquid, or gaseous (ionized gases), that may produce a reduction of dielectric strength or surface resistivity”.

- Pollution degree 1: No pollution or only dry, non-conductive pollution occurs. The pollution has no influence.
- Pollution degree 2: Normally only non-conductive pollution occurs. Occasionally, however, a temporary conductivity caused by condensation must be expected.
- Pollution degree 3: Conductive pollution occurs, or dry, non-conductive pollution occurs which becomes conductive due to condensation which is expected. In such conditions, equipment is normally protected against exposure to direct sunlight, precipitation, and full wind pressure, but neither temperature nor humidity is controlled.

---

**Storage Environment**

- Location: Indoor
- Temperature:  $-40\text{ }^{\circ}\text{C}$  to  $70\text{ }^{\circ}\text{C}$
- Humidity:  $< 90\%$  RH (non-condensing)

---

**Disposal**



Do not dispose this instrument as unsorted municipal waste. Please use a separate collection facility or contact the supplier from which this instrument was purchased. Please make sure discarded electrical waste is properly recycled to reduce environmental impact.

---



# GETTING STARTED

This chapter describes the GVM-9102 in a nutshell, including an Overview of its main features and front / rear panel introduction. After going through the Overview, follow the Power-up sequence to properly setup the GVM-9102.

Please note the information in this manual was correct at the time of printing. However, as GW Instek continues to improve its products, changes can occur at any time without notice. Please see the GW Instek website for the latest information and content.

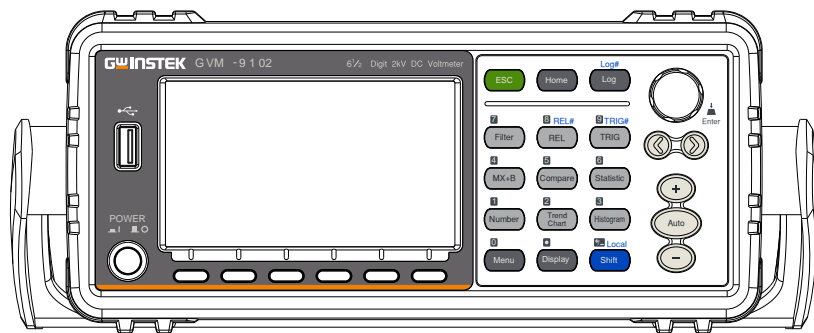

---

<b>Characteristics .....</b>	<b>10</b>
Accessories .....	11
<b>Front Panel Overview .....</b>	<b>12</b>
Measurement Keys .....	14
Math and Statistic Keys .....	15
Display Modes Keys .....	15
<b>Rear Panel Overview .....</b>	<b>16</b>
<b>Status Bar .....</b>	<b>19</b>
<b>Set Up .....</b>	<b>23</b>
Horizontal/Tilt/Vertical Applications .....	23
Power Up .....	24

## Characteristics

The GVM-9102 is a portable, 6 ½ digital DC Voltmeter suitable for a wide range of applications, such as production testing, research, and field verification.

---

<b>Performance</b>	<ul style="list-style-type: none"><li>• The highest DCV accuracy: 100 ppm</li><li>• The highest voltage: 2400 V</li><li>• The fastest sampling rate: 10 k Readings/sec</li><li>• Internal memory: 100 k read memory</li><li>• Data Logging to USB</li></ul>
<b>Features</b>	<ul style="list-style-type: none"><li>• 6 ½ digits</li><li>• Multi functions: DCV, REL, MX+B, Compare and Statistics.</li><li>• Manual or Auto ranging</li><li>• Standard SCPI command set</li><li>• Graph Display: BarMeter, TrendChart, Histogram</li></ul>
<b>Interface</b>	<ul style="list-style-type: none"><li>• USB device/RS232/GPIB (optional)/LAN for remote control</li><li>• 9-pin Digital I/O port</li><li>• USB device port supports USB CDC and USB TMC</li><li>• USB Host</li></ul>

---





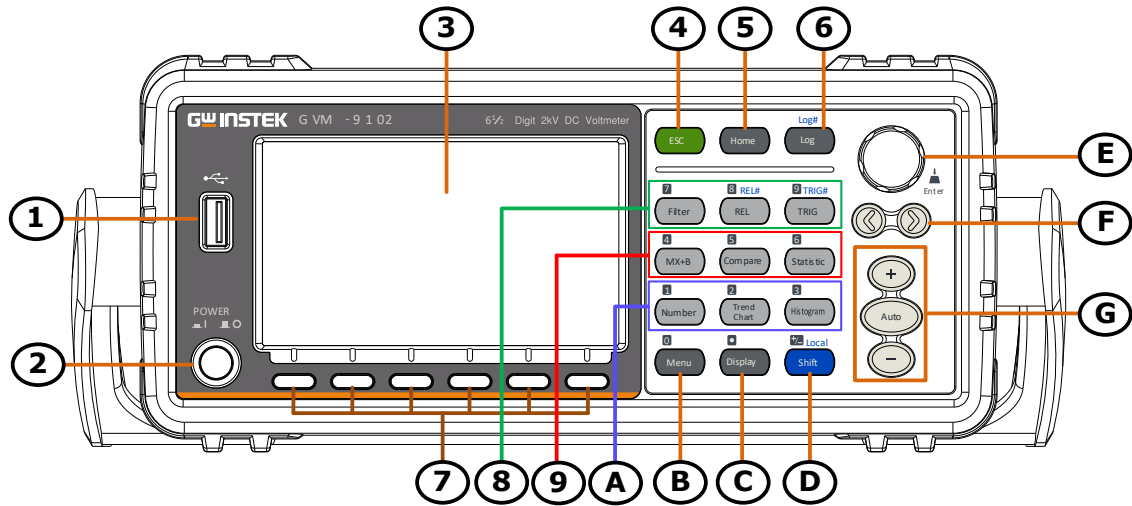

## Accessories





Standard Accessories	Part number	Description
	82DM-90610MA1	Safety Instruction Sheet
	GHT-116B/116R	Test leads
	GTL-246	USB Cable, USB 2.0, A-B type, 1200 mm
Optional Accessories	Part number	Description
	GDM-90G1	GPIB card for GVM-9102
	GTL-234	RS-232 Cable, approx. 2000 mm
	GTL-248	GPIB Cable, approx. 2000 m
	GRA-422	Rack Mount Kit (19" 2U)
	GRA-454	Rack Mount Kit (19", 2U) for two sets

# Front Panel Overview

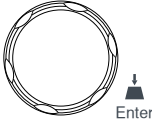
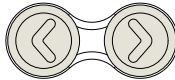
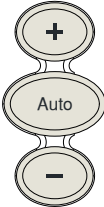





Item	Description
1	USB Host Port
2	Power Switch
3	Main Display
4	ESC (Escape) Key
5	Home screen Key
6	Log menu Key
7	Function keys (F1 through F6, functions vary per modes)
8	Measurement Keys (also the numerical keypad function)
9	Math and Statistic Keys (also the numerical keypad function)
A	Display Modes Keys (also the numerical keypad function)
B	Menu key (also the numerical keypad function)
C	Display key (also the numerical keypad function)
D	Shift key (also the numerical keypad function)
E	Knob key
F	Arrow keys (Speed selection keys)
G	Range keys

USB Host Port		Connects with USB flash drive for data storage.
Power Switch		Turns On  or Off  the main power. For the power up sequence, see page 24.
Main Display	The 4.3" TFT LCD shows measurement results and parameters. For display configurations, see page 96.	
ESC (Escape) Key		Single press to escape from current page. Presses and holds the ESC key for 2 seconds to toggle between full display and simple display, which conceals the status bar, math display as well as additional info for lightweight use.  Refer to page 19, page 102 and page 110 for more details of status bar, math display and additional info, respectively.
Home Key		Returns to the Home screen.
Screenshot / Data Log Saving Key		Captures the current screenshot or saves the data log for reading. For details, refer to page 115.
Function Keys	The 6 keys have varied functions per different settings.	
Knob Key		Scrolls the knob to select parameters in various setting pages. Press the key until click to confirm setting.
Arrow Keys		Presses the left or right arrow keys to move parameter cursor rightward or leftward per requirement.
Range Selection Keys		Presses the Auto key to activate auto-range mode, whilst clicking “+” or “-” key can increase or decrease range parameter, respectively.

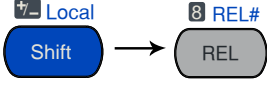

Menu		Enters the setting pages in various Menus (page 79).
Display		Display settings Key (page 123).
Shift		The Shift key is used to select the secondary functions assigned to each front panel key. When pressed, the Shift indicator appears in the display.
Local		For the Local key, it helps release from the remote control and returns the instrument to local panel operation (page 148).

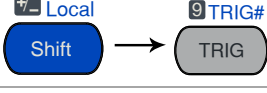
### Measurement Keys

Filter		Manually sets the parameters for the Filter function (page 41).
REL		Measures the Relative value (page 34).
Shift → REL (REL#)		Manually sets the reference value for the Relative value measurement (page 34).
TRIG (Trigger)		Activates the Trigger function (page 36).
Shift → TRIG (TRIG#)		Manually sets the parameters for the Trigger function (page 36).

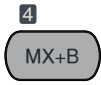

## Math and Statistic Keys

---

MX+B		Enters the MX+B mode under the Math functions (page 51).
Compare		Enters the Compare mode under the Math functions (page 45).
Statistic		Enters the Statistic display to show several values including Minimum, Maximum, Average, Peak-Peak, Standard Deviation and Count.

## Display Modes Keys

---

Number		Enters the Number display mode for measurement (page 126).
Trend Chart		Enters the Trend Chart display mode for measurement (page 132).
Histogram		Enters the Histogram display mode for measurement (page 141).

# Rear Panel Overview

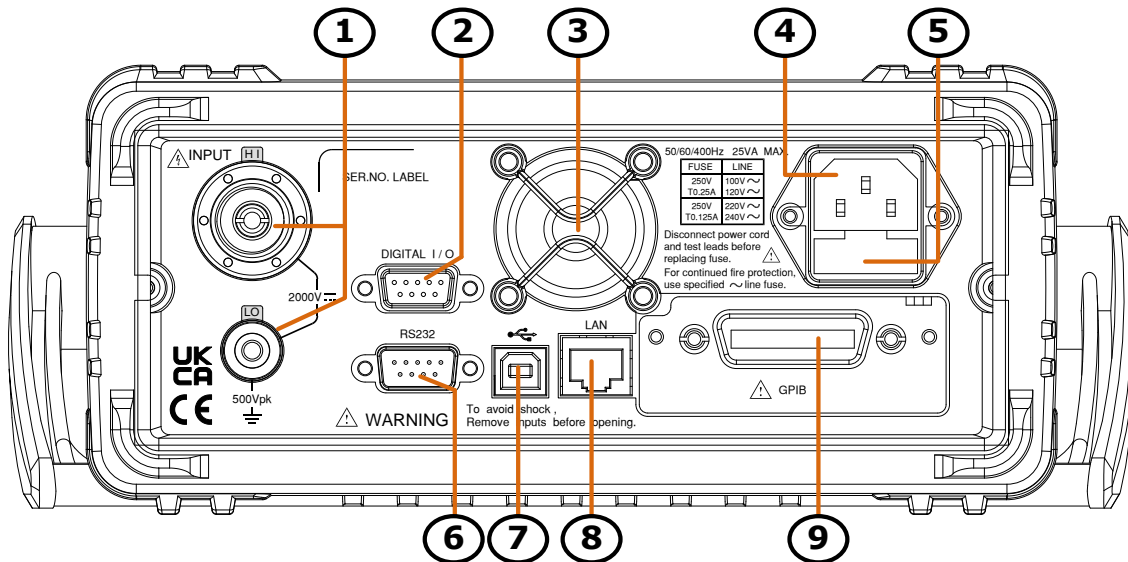

Item	Description
1	HI and LO Input Terminals
2	DIGITAL I/O Connector
3	Fan Vents
4	AC Mains Input (Power Cord Socket)
5	AC Mains Line Voltage Selector and Fuse Socket
6	RS-232 Interface Connector
7	USB Interface Connector (B Type)
8	Ethernet (LAN) Connector
9	GPIB Connector (optional)



Input HI  
Terminal

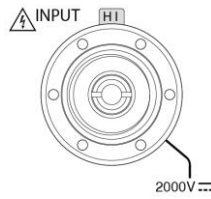

Used as an Hi-volt input port for all measurements.

Input LO Terminal

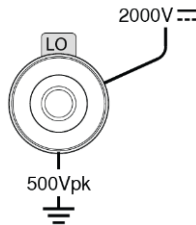

Accepts ground (COM) line in all measurements. The maximum withstand voltage between this terminal and earth is 500 Vpk.

Digital I/O port

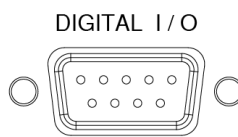

Accepts a digital I/O cable for the Hi/Lo limit tests; DB-9 pin, female connector.

For digital I/O details, see page 54.

Fan Vents

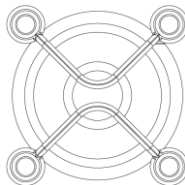

For heat ventilation when machine is under operation.

Power Cord Socket

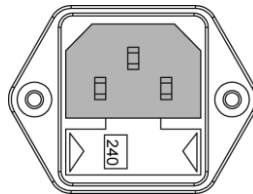

Accepts the power cord. AC 100 V / 120 V / 220 V / 240 V  $\pm$  10 %, 50 Hz / 60 Hz / 400 Hz  $\pm$  10 %.

For power on sequence, see page 24.

Line Voltage Selector and Fuse Socket

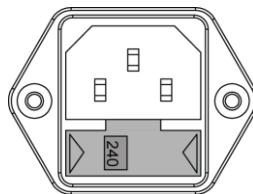

Holds the main fuse:

100 / 120 VAC: T 0.25 A

220 / 240 VAC: T 0.125 A

For fuse replacement details, see page 239.

RS-232C port

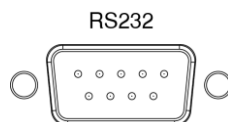

Accepts an RS-232C cable for remote control; DB-9 male connector.

For remote control details, see page 151.

USB device port

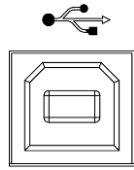

Accepts a USB device cable for remote control; Type B, female connector.

For remote control details, see page 148.

LAN port

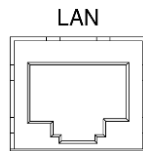

Accepts a LAN for remote control;

For remote control details, see page 166.

Optional GPIB port

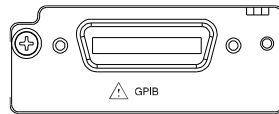

Accepts an optional GPIB card.

For GPIB details, see page 161.







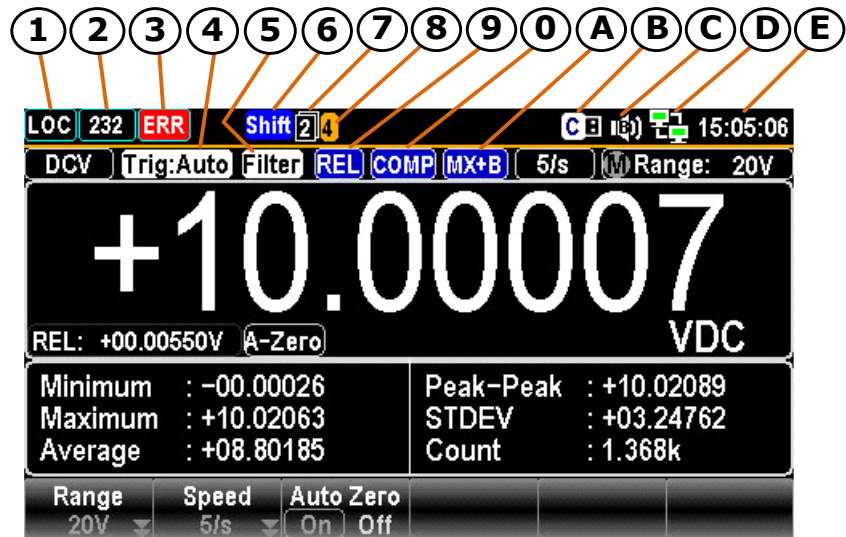



## Status Bar







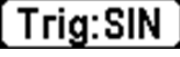
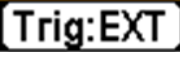





Background Identify each icon and indicator within the top status bar.

Status Bar Display







Item	Description
1	Local/Remote control icon
2	RS-232/USB-CDC/USB-TMC/LAN/GPIB interface icon
3	Error icon for commands from remote control
4	Trigger function indicator
5	Filter function indicator
6	Shift key identification icon
7	The first and second function menu switch icon
8	Digital I/O mode icon (User/4094)
9	Relative value function indicator
0	Compare function indicator
A	MX+B function indicator
B	USB flash drive connection icon
C	Beep/Key Sound setting icon
D	Internet connection status icon
E	Time display

Local Control		It indicates the unit is under local control mode.
Remote Control		It indicates the unit is under remote control. Refer to page 147 for details.
RS-232		It indicates RS-232 interface is activated. Refer to page 151 for details.
USB - CDC		It indicates USB - CDC interface is activated. Refer to page 150 for details.
USB - TMC		It indicates USB - TMC interface is activated. Refer to page 150 for details.
LAN		It indicates LAN interface is activated. Refer to page 166 for details.
GPIB		It indicates GPIB interface is activated. Refer to page 161 for details.
ERROR		It indicates error occurs in commands. To erase the error icon, it is required to read or sweep the error by remote control commands or reboot action. Refer to page 220 for details.
Trigger Auto		It indicates the Trigger Auto mode is activated. Refer to page 36 for details.
Trigger Single		It indicates the Trigger SIN mode is activated. Refer to page 36 for details.
Trigger EXT		It indicates the Trigger EXT mode is activated. Refer to page 37 for details.
Filter		It indicates the filter function is activated. Refer to page 41 for details.
Shift		It indicates the shift key is being pressed ready for in conjunction with other keys for additional functions. Refer to page 14 for details.

First function menu		It indicates the active bottom menu corresponding to function keys is the first menu. Click the Knob key (Enter) to switch to the second function menu.
Second function menu		It indicates the active bottom menu corresponding to functional keys is the second menu. Click the Knob key (Enter) to switch to the first function menu.
Digital I/O – 4094 mode		It indicates Digital I/O – 4094 mode is enabled. Refer to page 64 for details.
Digital I/O – User mode		It indicates Digital I/O – User mode is enabled. Refer to page 64 for details.
Relative		It indicates the Relative value function is activated. Refer to page 34 for details.
Compare		It indicates the Compare function is activated. Refer to page 45 for details.
MX+B		It indicates the MX+B function is activated. Refer to page 51 for details.
Flash Drive – Capture		It indicates the Capture mode is ready for the connected flash drive. Refer to the page 115 for details of Capture.
Flash Drive – Save Reading		It indicates the Save Reading mode is ready for the connected flash drive. Refer to page 119 for details of Save Reading.
Flash Drive – Failure		It indicates something error occurs and thus flash drive fails to connect to unit.
Sound – Beep		It indicates sound of beep is enabled. Refer to page 79 for details.
Sound - Key		It indicates sound of key is enabled. Refer to page 80 for details.
Sound – All		It indicates sounds of beep and key are both enabled.

---

Sound – Off		It indicates sounds of beep and key are both disabled.
Internet On		It indicates internet connection is established. Refer to page 166 for details.
Internet Off		It indicates internet connection is Not well established.
Time Display		It indicates the time display. For detailed setting, refer to page 82.

---

# Set Up

## Horizontal/Tilt/Vertical Applications

---

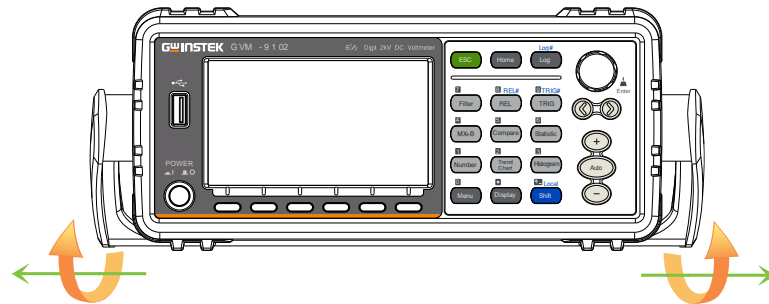

Pull out the handle sideways and rotate it clockwise for the applications below.

---

### Horizontal

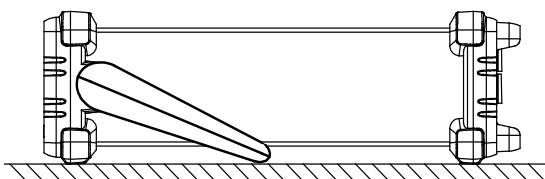

Place the unit horizontally.

### Tilt

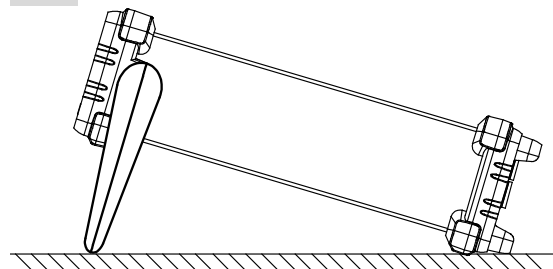

Rotate the handle for tilt stand.

### Vertical

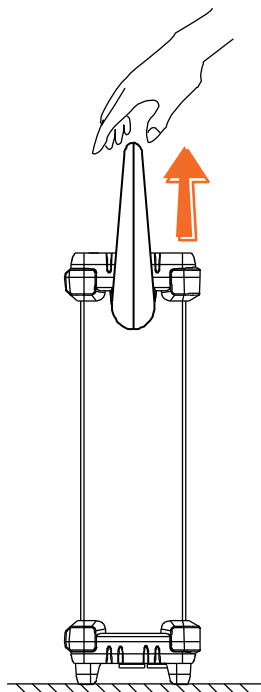

Place the handle vertically for hand carry.

---

## Power Up

---

### Steps

1. Ensure the correct line voltage is clearly shown on the fuse socket (240V in the right figure for example). If not, see page 239 to set the proper line voltage and fuse.

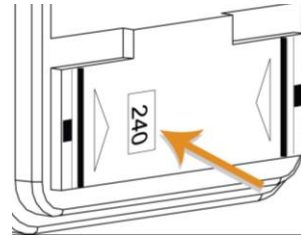

2. Connect the power cord to the AC Voltage input.

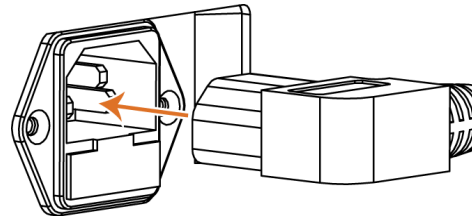

Note

Make sure the ground connector on the power cord is connected to a safety ground. This will affect the measurement accuracy.

3. Push the power button until click to turn on the main power switch on the front panel.



4. The screen firstly shows the logo brand of GWINSTEK followed by the message “Load the default parameter” indicating default parameter is loaded in the initial startup.

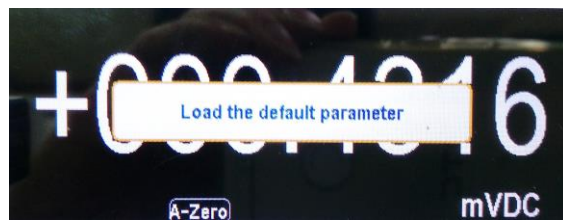



# BASIC MEASUREMENT

---

<b>Basic Measurement Overview .....</b>	<b>26</b>
Refresh Rate .....	26
Automatic (Internal)/Single Triggering .....	27
<b>DCV Measurement .....</b>	<b>28</b>
Select Voltage Range .....	29
General Voltage Setting .....	30
Voltage Conversion Table .....	31
Crest Factor Table .....	32

# Basic Measurement Overview

## Refresh Rate

**Background** Refresh rate defines how frequently the GVM-9102 captures and updates measurement data. A faster refresh rate yields a lower accuracy and resolution. A slower refresh rate yields a higher accuracy and resolution. Consider these tradeoffs when selecting the refresh rate.

Measurement Type	Refresh Rate Available									
DCV	5/s	20/s	60/s	100/s	400/s	1.2k/s	2.4k/s	4.8k/s	7.2k/s	10k/s

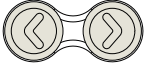
**Selection Procedure** Press the left or right arrow keys to change the refresh rate. 

You can also press the F2 (Speed) key to select a desired rate for measurement. Press corresponding function key in accord with the desired option on screen display. Also, the F6 (More 1/2) key shows when available options are more than single page.

**Speed**

**More 1/2**



The refresh rate will be shown at the upper right corner of the display. See the example below.

Active Refresh Rate



**Reading indicator** The reading indicator , which is located at the lower-right corner of display, flashes according to the defined refresh rate setting.

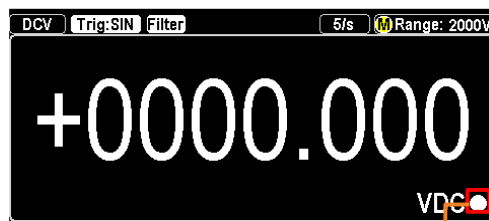

Reading Indicator

## Automatic (Internal)/Single Triggering

**Overview** By default, the GVM-9102 automatically triggers according to the refresh rate. See the previous page for refresh rate setting details. The TRIG key, on the other hand, is used to manually trigger once per click.

**Single Trigger** Simply press the TRIG key to Single trigger measurement. Pressing once stands for trigger for single time. See the figure below for example.



Indicator Single Trigger Mode



**Automatic (Internal) Trigger** Press and hold the TRIG key for 2 seconds to return to the Automatic (Internal) Trigger.



(Press & hold for 2 seconds)

Indicator Auto (Internal) Trigger Mode

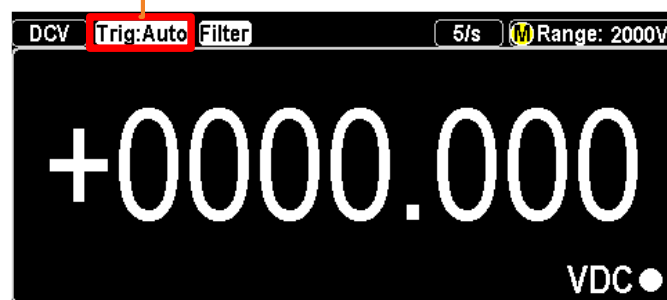

# DCV Measurement

Voltage type      DC      0 ~ 2400 V

DCV mode display appears      The mode will switch to DCV mode immediately. See the figure below for example.

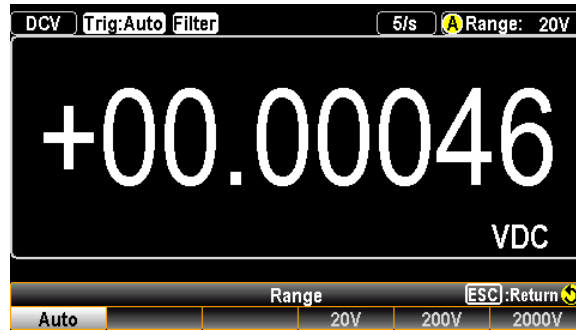

DCV	Indicates DCV mode
5/s	Indicates the active refresh rate
	Indicates Automatic range selection
Range: 20 V	Indicates the available range of Voltage
+00.00046 VDC	Indicates the exact measured value

Connect the test leads and measure      Connect the test leads between the Input HI and Input LO terminals. The display updates the reading.

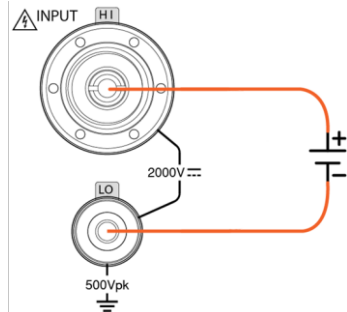

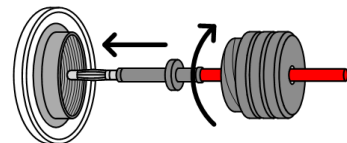

HI Input terminal Connection      Connect the high voltage test lead (Red) to the Input HI terminal and screw clockwise firmly into place as the figure in right side shown.



## Select Voltage Range

**Auto range** To turn the automatic range selection On/Off, press the Auto key. 

**Manual range** Press the “+” or the “-” key to select the range. The Auto indicator  turns to  indicating Manual range selection.

If the appropriate range is unknown, select the highest range.

You can also press the F1 (Range) key to select a range for the measurement.



Press the F1 ~ F6 key to select a desired range for the voltage measurement.



Selection list	Range		
	Range	Resolution	Full scale
	20 V	10 $\mu$ V	24.00000 V
	200 V	100 $\mu$ V	240.0000 V
	2000 V	1 mV	2400.000 V

 **Note** For more detailed parameters, see the specifications on page 246.

## General Voltage Setting

F2 (Speed) key to select refresh rate

Press the F1 ~ F5 key to select the desired rate



Press the F6 (More 1/2) key for next page with more options as the figure shown below.



F3 (Auto Zero) key to enable Auto Zero





**Background** Autozero provides the most accurate measurements, but requires additional time to perform the zero measurement. With autozero enabled (On), the GVM-9102 internally measures the offset following each measurement. It then subtracts that measurement from the preceding reading. This prevents offset voltages present on the GVM-9102's input circuitry from affecting measurement accuracy. With autozero disabled (Off), the GVM-9102 measures the offset once and subtracts the offset from all subsequent measurements.



**Display** When turning On the Auto Zero, the display shows an icon **A-Zero** indicating the Auto Zero mode is currently being activated.

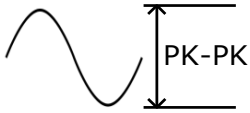
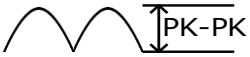

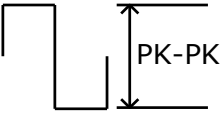

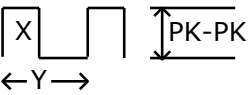
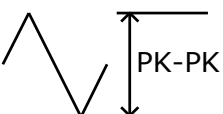

## Voltage Conversion Table

**Background** This table shows the relationship DC reading in various waveforms.

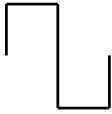
Waveform	Peak to Peak	AC (True RMS)	DC
Sine 	2.828	1.000	0.000
Rectified Sine (full wave) 	1.414	0.435	0.900
Rectified Sine (half wave) 	2.000	0.771	0.636
Square 	2.000	1.000	0.000
Rectified Square 	1.414	0.707	0.707
Rectangular Pulse 	2.000	$2K$ $K = \sqrt{D - D^2}$ $D = X/Y$	$2D$ $D = X/Y$
Triangle Sawtooth 	3.464	1.000	0.000

## Crest Factor Table

**Background** Crest factor is the ratio of the peak signal amplitude to the RMS value of the signal. It determines the accuracy of AC measurement. If the crest factor is less than 3.0, voltage measurement will not result in error due to dynamic range limitations at full scale. If the crest factor is more than 3.0, it usually indicates an abnormal waveform as seen from the below table.

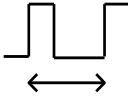
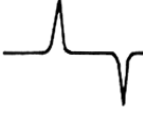
Waveform	Shape	Crest factor
Square wave		1.0
Sine wave		1.414
Triangle sawtooth		1.732
Mixed frequencies		1.414 ~ 2.0
SCR output 100% ~ 10%		1.414 ~ 3.0
White noise		3.0 ~ 4.0
AC Coupled pulse train		>3.0
Spike		>9.0



# ADVANCED MEASUREMENT

---

<b>Advanced Measurement Overview</b> .....	<b>34</b>
<b>Relative Value Measurement</b> .....	<b>34</b>
<b>Trigger Setting</b> .....	<b>36</b>
Automatic/Single Triggering .....	36
Use External Trigger .....	37
Set Trigger Delay .....	40
<b>Filter Setting</b> .....	<b>41</b>
Digital Filter Overview .....	41
Digital Filter Setting .....	43
<b>Math Measurement</b> .....	<b>44</b>
Compare Mode .....	45
MX+B Measurement.....	51

# Advanced Measurement Overview

**Background**      Advanced measurement mainly refers to the type of measurement which uses the result obtained by one of the basic measurements:

Advanced Measurement	Basic Measurement
	DC Voltage
Relative	✓
Trigger	✓
Filter	✓
Compare	✓
MX+B	✓

## Relative Value Measurement

**Background**      Relative measurement stores a value, typically the data at the moment, as the reference. The following measurement is shown as the delta between the references. The reference value will be cleared upon exit.

REL, basically, is to subtract a certain value in the following measurement. The value is fixed and remains its effect even user exits and returns back to this function again.

One of the most seen purposes of REL is to eliminate impedance of test lead from measurement. Before operating impedance measurement, short circuit the test lead followed by pressing the [REL] button. For other measurements, press the [REL] button after putting test lead in a null circuit.

Alternatively, user can modify the value by pressing the [REL#] button followed by using the knob or number keys to enter a specified value. Press the [REL] button again to disable null operation.

**Activate Relative measurement**      Press the REL key. The measurement reading at the moment becomes the reference value.



Relative measurement display appears

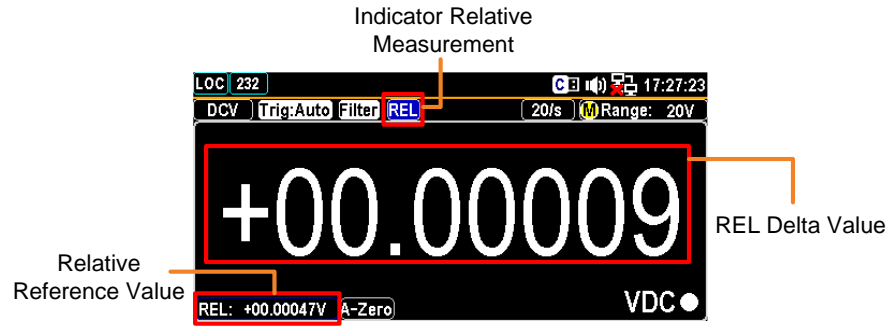

REL Indicates Relative value measurement

REL: +00.00047 V Shows the stored reference value

+00.00009 Shows the delta between the current measurement data and the reference value

Manually set the reference value

To set the reference (REL) value manually, press the Shift key followed by the REL key. The setting appears.

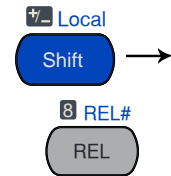

First use function keys to decide unit value. Then use the Left/Right arrow keys to move cursor and scroll the Knob key or press Number keys to enter the desired value.

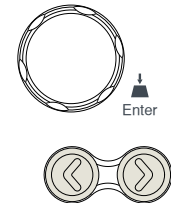

Press the F6 (Enter) key or the Knob key until click to confirm the relative value setting.

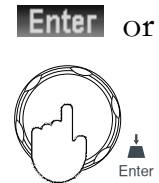

Deactivate Relative measurement

To cancel the Relative measurement, press the REL key again, or simply activate another measurement.



# Trigger Setting

## Automatic/Single Triggering

**Automatic triggering (default)** By default, the GVM-9102 triggers according to the refresh rate automatically. See the previous page for refresh rate setting details. The figure below shows the screen of Automatic Trigger measurement.

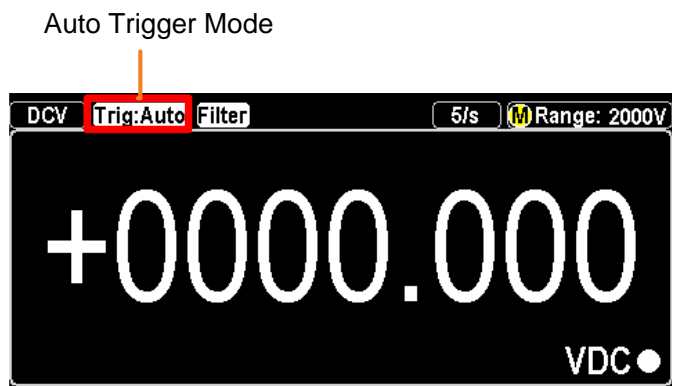

**Single triggering** Press the TRIG key to Single trigger measurement. See below for details.

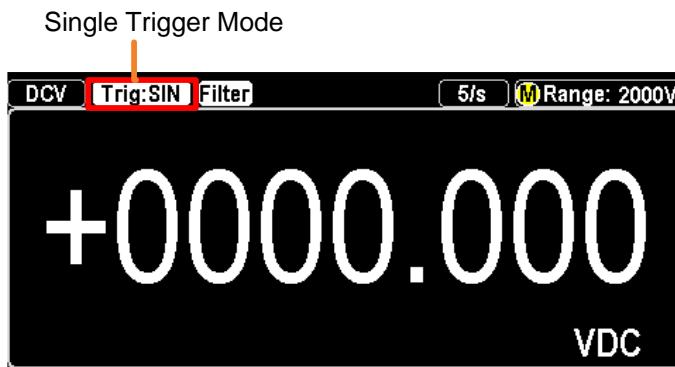

- Change mode**
- Under Single Trigger mode, press and hold the TRIG button for at least 2 second to return to Auto Trigger mode.
  - Under Auto Trigger mode, simply press the TRIG button to return to Single Trigger mode.



## Use External Trigger

**Background** The GVM-9102 uses the internal trigger by default, for example to count the frequency and the period. Using an external trigger allows customized triggering conditions.

**Signal connection** Connect the external trigger signal to the Digital I/O port located on the rear panel.

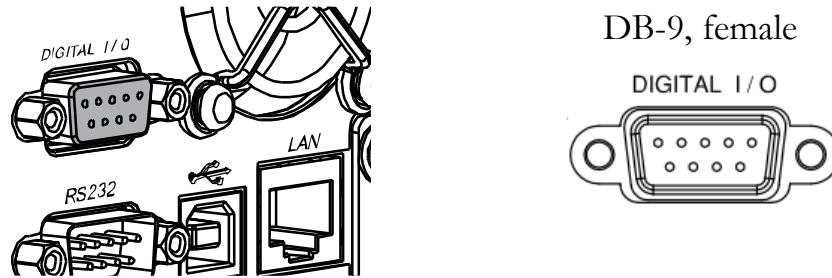

**Digital I/O pin assignment**

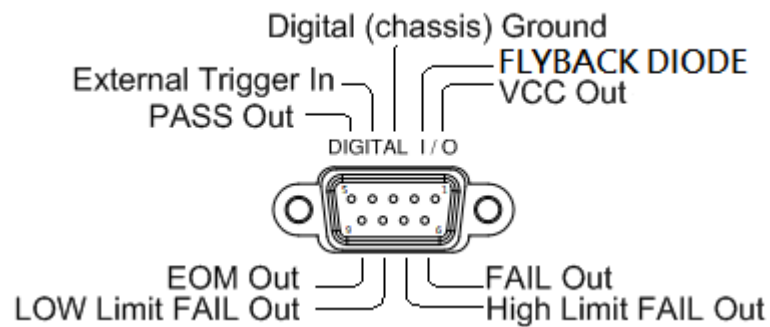

Activate external trigger

Press the Shift + TRIG key to activate setting menu of trigger.

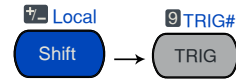

Press the F1 (TrigSource) key to enter the trigger source menu followed by pressing the F3 (EXT) to select External Trigger mode.

**TrigSource**

**EXT**



The “EXT” indicator appears on the display.

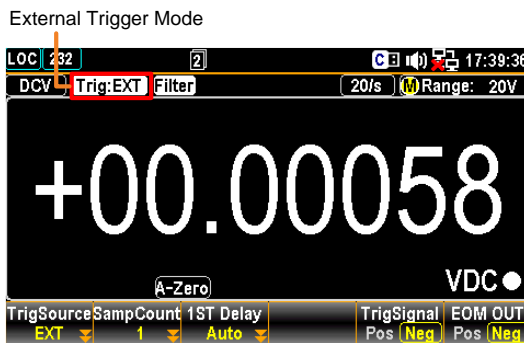

Set sample count

- Under the setting menu of trigger, press the F2 (SampCount) key to enter the ensuing setting of Sample Count. Use the Left/Right arrow keys to move cursor and scroll the Knob key or press Number keys to enter the desired counts.

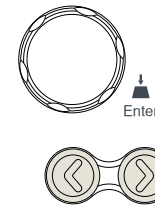

- Push the Knob key (Enter) or press the F6 (Enter) key to confirm the input value.  
Range: 1 ~ 1,000,000

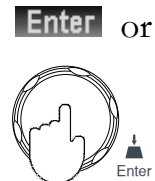

Set Trigger Signal

Background When utilizing external trigger, select either positive or negative terminal as the main trigger source in light of the actual applications.

Press the F5 (TrigSignal) key to toggle between Positive and Negative mode for Trigger Signal.

**TrigSignal**



**Set EOM OUT Background** It indicates EOM (End Of Measurement) output signal. Select Positive or Negative as the output signal for extension applications when necessary.

Press the F6 (EOM OUT) key to toggle between Positive and Negative mode for EOM OUT setting.



**Reading indicator** The reading indicator  does not flash before triggering (can be on or off). After triggering, the indicator flashes according to the external signal trigger timing.

**Exit external trigger**

Press the F1 (TrigSource) key to reenter the TrigSource menu followed by pressing the F1 (Auto) or the F2 (Single) key to switch to other trigger modes.



Alternatively, it is viable to simply click the TRIG button to change to Trig:SIN mode or click and hold the TRIG button for 2 seconds to enter the Trig:Auto mode.



## Set Trigger Delay

**Background** Trigger delay defines the time delay between triggering and measurement start. The default is set at 200us.

**Manual trigger delay**

1. Press the Shift + TRIG key to activate setting menu of trigger.

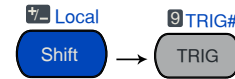

2. Press the F3 (1ST Delay) key to enter the Trigger Delay (1ST) menu. The Trigger Delay setting appears as the figure below.



3. Press the F4 (AutoDelay) key to switch to the manual delay time setting.



4. Use F1 – F3 keys to decide unit value. Then use the Left/Right arrow keys to move cursor and scroll the Knob key or press Number keys to enter the desired value.

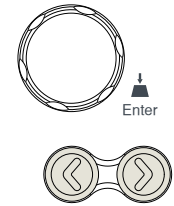

5. Push the Knob key (Enter) or press the F6 (Enter) key to confirm the input value.



Range: 0 ~ 3600s, 1us resolution

- Auto trigger delay**
1. Repeat the steps 1 – 2 of manual trigger delay first, and press the F4 (AutoDelay) key to switch the display as the following.



2. Press the ESC key to return to the previous page and have the auto trigger delay setting take effect. The 1ST display will be shown like the following figure.





# Filter Setting

## Digital Filter Overview

**Filter basics**      The GVM-9102 internal digital filter converts the analog input signal into digital format before passing it to internal circuits for processing. The filter affects the amount of noise included in the measurement result.

**Filter type**      The digital filter averages a specific number of input signal samples to generate one reading. The filter type defines the averaging method. The following diagrams highlight the differences between the Moving and Repeating filter using 4 samples per reading.

**Moving (default)**      The Moving filter takes in one new sample and discards the oldest sample per reading. This is the default behavior when the digital filter is not specified, and is recommended for most applications.

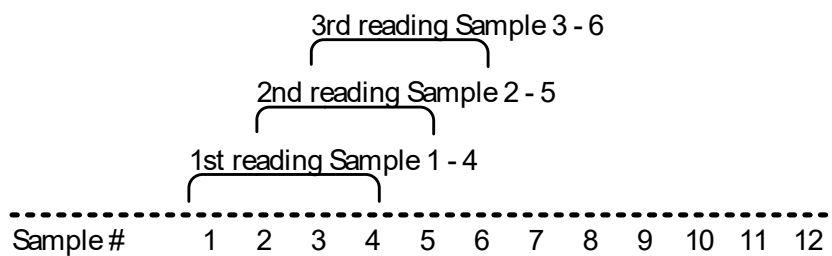

**Repeating**      The Repeating filter renews a whole group of samples per reading.

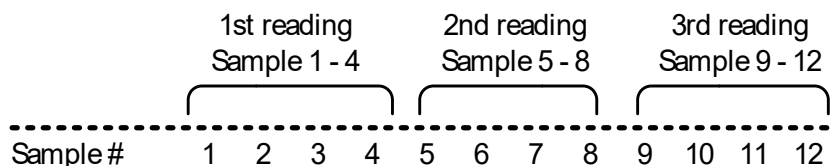

**Filter count** Filter count defines the number of samples to be averaged per reading. More samples offer low noise but a long delay. Less samples offer high noise but a short delay.

**Range** 2 ~ 100

**Filter window** Filter window defines the threshold for when the digital filter data is updated again. When the AD data falls in the range between TH and TL, the filter keeps processing. When the AD data falls out of the range between TH and TL, the filter will restart. When measuring unstable signals, appropriately setting the filter window can improve the measurement speed.

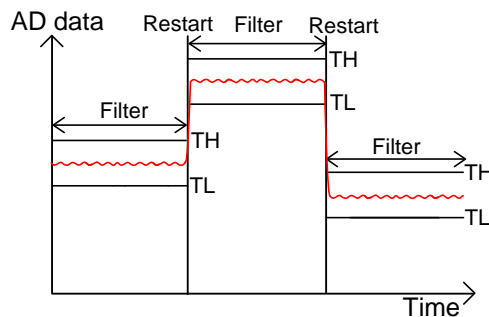

TH: Threshold High, TL: Threshold Low

**Filter window Formula**

**Measure:**  
 $Previous\ Meas * (1 - window) < threshold < Previous\ Meas * (1 + window).$

**Range:**  
 $Previous\ Measure + (Range * window) < threshold < Previous\ Measure + (Range * window)$

There are 5 windows range settings that can be chosen: 10%, 1%, 0.1%, 0.01% and none

## Digital Filter Setting

**Filter setting** Press the Filter key. The Filter setting menu shows as the figure below.



**Turn on filter** Press the F2 (Filter) key to turn On or Off filter function. The Filter indicator appears on the display.

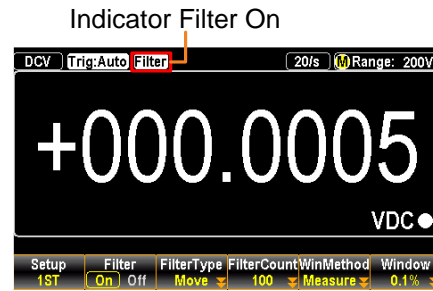

**Choose filter type** Press the F3 (FilterType) key to enter the subsequent menu. Press the F1 or F2 keys to select desired filter type.



**Define filter count** Press the F4 (FilterCount) key to enter the subsequent menu. Use the Left/Right arrow keys to move cursor and scroll Knob key or press Number keys to enter the desired value.



Press the F6 (Enter) key or the Knob key until click to confirm the filter count settings.

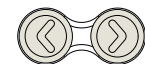

Range: 2 ~100

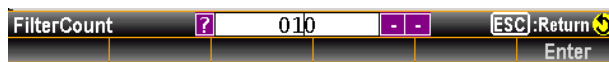

**Set filter window method** Select the Filter Window Method by clicking the F5 (WinMethod) key. The display changes accordingly as the figure below shown. Press the F1 or F2 keys to choose desired Filter Window Method.



**Define filter window** Press the F6 (Window) key to enter the subsequent menu. Press the F1 – F5 keys to choose desired Filter Window percentage.



**Range** 0.01%, 0.1%, 1%, 10%, None

**Turn off Filter** Press the Filter key. Press the F2 (Filter) key to turn Off Filter function.



The Filter indicator will disappear from display.



## Math Measurement

**Background** Math measurement runs 2 types of mathematical operations, Compare and MX+B based on the other measurement results.

**Math Equation** **Compare** Checks and updates if measurement data stays between the specified upper (high) and lower (low) limit.

**MX+B** Multiplies the reading (X) by the factor (M) and adds/subtracts offset (B).

## Compare Mode

**Background** The Compare mode checks and updates if measurement data stays between the specified upper (high) and lower (low) limit.

**Activate Compare mode** Click the Compare key on the front panel followed by pressing the F1 (COMP) key to turn ON the Compare function. The screen, after activation, will appear as figure below.

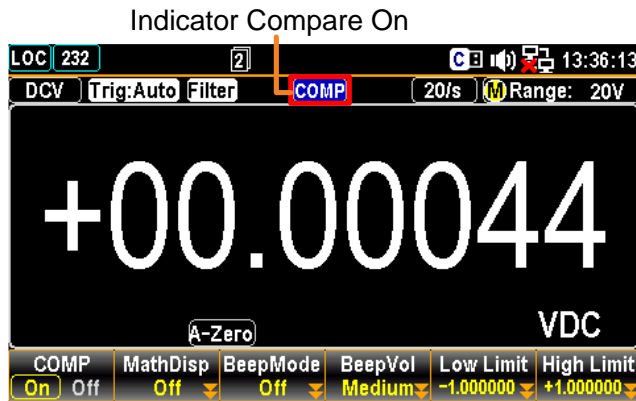

**F6 (High Limit) to set high limit**

Press the F6 (High Limit) key to enter the setting menu.



First use the functions keys to determine the unit, which varies by different measure modes. Then use the Left/Right arrow keys to move cursor and scroll the Knob key or press Number Keys to enter the desired value of high limit.

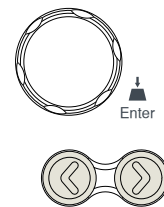

Push the F6 (Enter) key or the Knob key (Enter) to make the setting into effect.

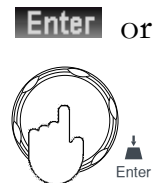

**F5 (Low Limit) to set low limit**

Press the F5 (Low Limit) key to enter the setting menu.



First use the functions keys to determine the unit, which varies by different measure modes. Then use the Left/Right arrow keys to move cursor and scroll the Knob key or press Number Keys to enter the desired value of low limit.

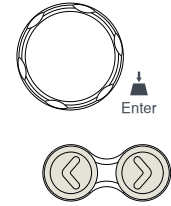

Push the F6 (Enter) key or the Knob key (Enter) to make the setting into effect.

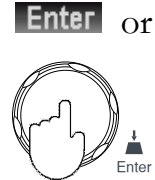

**F3 (BeepMode) to define beep mode**

Press the F3 (BeepMode) key to enter the beep mode setting. By enabling beep mode, user can be aware of the latest state promptly by beep voice.

The display shows as the figure below. Press the F2 (Pass) or F3 (Fail) key to determine the condition of beep alarm.

Press the F1 (Off) key to disable beep mode.



**BeepMode**

**Pass**

or

**Fail**

**Off**

**F4 (BeepVol) to select beep volume**

Press the F4 (BeepVol) key to enter the beep volume setting.

Select the intensity of beep volume via pressing F1 – F3 key for desired level as the figure shown below.



**BeepVol**

**Small**

or

**Medium**

or

**Large**

Compare mode result

When the measured result is within the range of high and low limit, the display shows as the figure below with purely black background indicating the state of “Pass”.

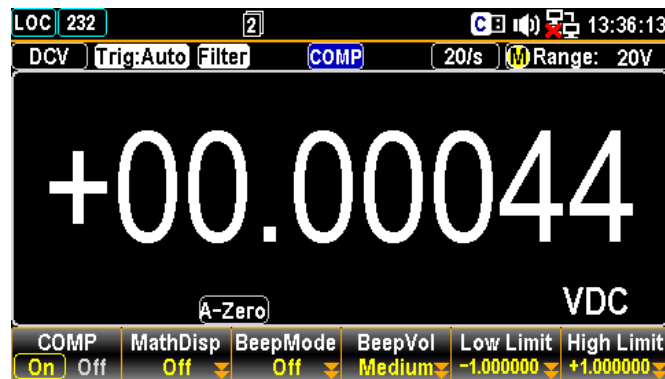

However, when measured result is either above or less than the limit range, the display appears as the figure below with boldly red background indicating the state of “Fail”.

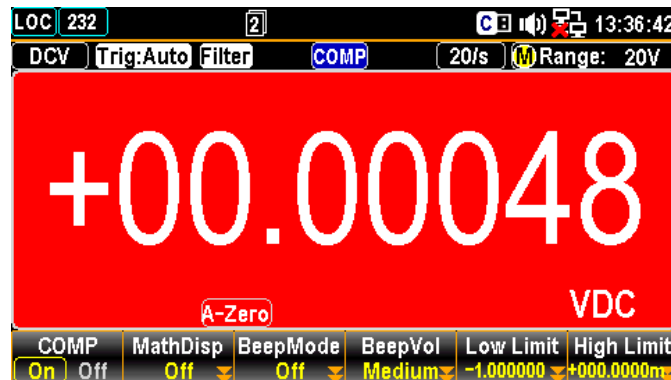

See the contents below for more details of each state in compare mode

**High** If the compare result is High, the relative pins of digital I/O port in action are as the follows.

Digital I/O: FAIL Out (Pin 6) and HIGH Limit FAIL Out (Pin 7) are activated.

**Low** If the compare result is Low, the relative pins of digital I/O port in action are as the follows.

Digital I/O: FAIL Out (Pin 6) and LOW Limit FAIL Out (Pin 8) are activated.

**Pass** If the compare result is Pass, the relative pin of digital I/O port in action is as the follows.

Digital I/O: PASS Out (Pin 5) is activated.

F2 (MathDisp) key Press the F2 (MathDisp) key to show the Math Display menu as the figure below to show STAT, Math & Math+STAT (Math) or F4 (Math+STAT) display in accord with the following chapters.



**Show STAT result** Background The STAT page in MathDisp allows you to make statistical calculations for several measurements including Minimum, Maximum, Average Peak-Peak, Standard Deviation and Count.

Operation Press the F2 (STAT) key **STAT** to show the statistical data as the figure below.

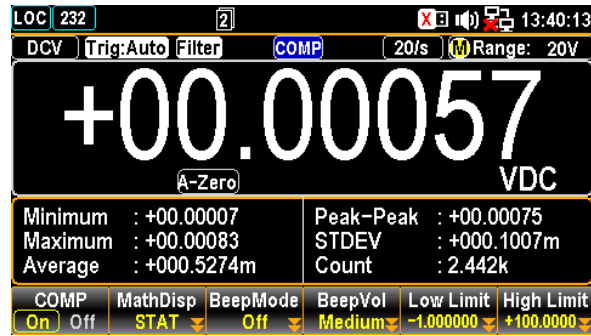

View Data	+00.00057 VDC	Indicates the currently measured VDC value
	Minimum	Indicates the minimum data value
	Maximum	Indicates the maximum data value
	Average	Indicates the mean (average) value
	Peak-Peak	Indicates the peak to peak data
	STDEV	Indicates the standard deviation of the data
	Count	Indicates the latest counts of compare

**Show Math result** Background The Math page in MathDisp allows you to view mathematical calculations for several parameters.



Operation Press the F3 (Math) key **Math** to show the mathematical analysis as the figure below.

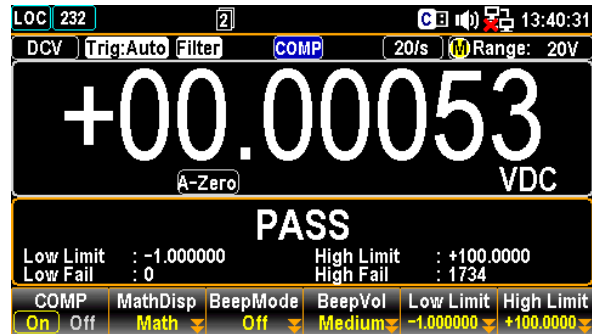

View Data	+00.00053 VDC	Indicates the currently measured VDC value
	Low Limit	Indicates the defined low limit
	Low Fail	Indicates the counts of below the defined low limit
	High Limit	Indicates the defined high limit
	High Fail	Indicates the counts of above the defined high limit

Show Math+STAT result

Background The Math+STAT page in MathDisp allows you to view data from both statistical calculations and mathematical analysis.

Operation Press the F4 (Math+STAT) key **Math+STAT** to show the hybrid page of Math & STAT instantly as figure below.

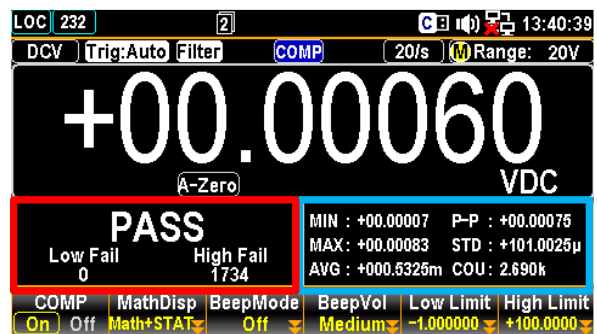

View Data	+00.00060 VDC	Indicates the currently measured VDC value
	Blue Section	It is identical to the contents of STAT display. Refer to the previous chapter for details.

Red Section It is identical to the contents of Math display. Refer to the previous chapter for details.

Compare live-result in MathDisp

The latest state of compare measurement, whether it's "Pass", "High" or "Low", will also appear within each mode of MathDisp. See the example below for the "High" result in Math+STAT mode.

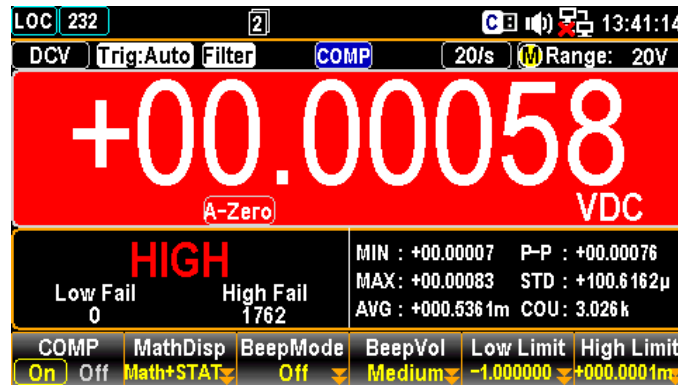

The boldly red background along with the indicator "HIGH" within the display means the compare result is over the range of defined high limit.

Digital I/O

The Compare measurement result comes out from the rear panel Digital I/O terminal. For the terminal details, see page 54.

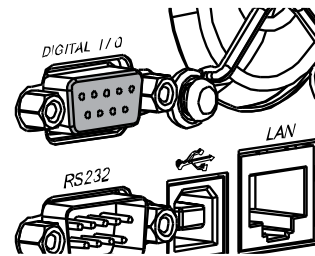

Deactivate Compare measurement

To cancel the Compare measurement, press the F1 (COMP) key and toggle to Off to deactivate the function.



## MX+B Measurement

**Activate MX+B** Click the MX+B key on the front panel followed by pressing the F1 (MX+B) key to turn ON the MX+B function. The screen, after activation, will appear as figure below.

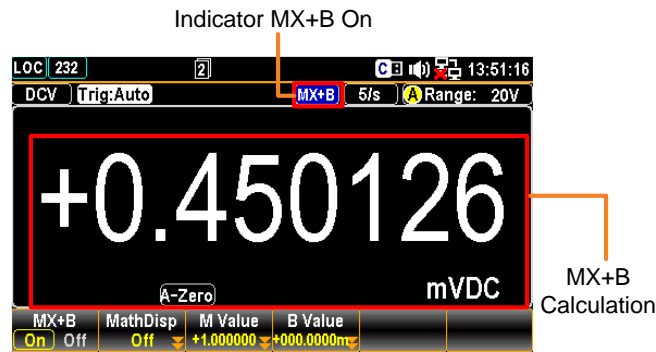
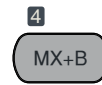

**F3 (M Value) key to set the factor M** Press the F3 (M Value) key to enter the MX+B M Value menu. First use function keys to decide unit value, which may vary by different measurements. Then use the Left/Right arrow keys to move cursor and scroll the Knob key or press Number keys to enter the desired value. See the figure below.

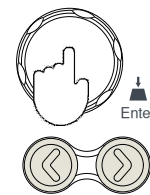

Press the F6 (Enter) key or the Knob key until click to confirm the input M value.



**F4 (B Value) key to set the offset B** Press the F4 (B Value) key to enter the setting menu. First use function keys to decide unit value, which may vary by different measurements. Then use the Left/Right arrow keys to move cursor and scroll the Knob key or press Number keys to enter the desired value. See the figure below.

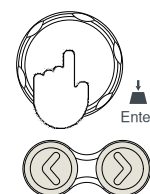

Press the F6 (Enter) key or the Knob key until click to confirm the input B value.



F2 (MathDisp) key to show STAT & Math

Press the F2 (MathDisp) key to show the option menu as the figure below shown.



Proceed to the F2 (STAT) or F3 (Math) display in accord with the following chapters.



Show STAT result

**Background** The STAT page in MathDisp allows you to make statistical calculations for several measurements including Minimum, Maximum, Average Peak-Peak, Standard Deviation and Count.

**Operation** Press the F2 (STAT) key  to show the statistical data immediately as the figure below.

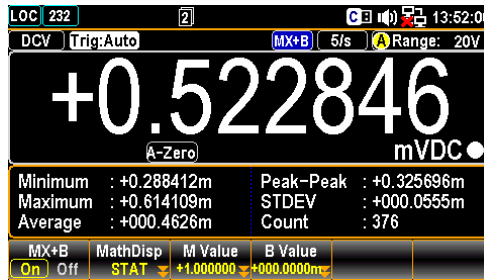

View Data	+0.522846 mVDC	Indicates the currently MX+B calculating result
	Minimum	Indicates the minimum data value
	Maximum	Indicates the maximum data value
	Average	Indicates the mean (average) value
	Peak-Peak	Indicates the peak to peak data
	STDEV	Indicates the standard deviation of the data
	Count	Indicates the latest counts of MX+B

**Show Math result**      **Background**      The Math page in MathDisp allows you to view mathematical calculations for several parameters.

**Operation**      Press the F3 (Math) key  to show the mathematical analysis instantly as below.

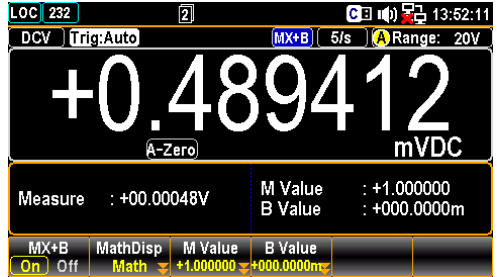

<b>View Data</b>	+0.489412 mVDC	Indicates the currently MX+B calculating result
	Measure: +00.00048 V	Indicates the originally measured Voltage value
	M Value	Indicates the defined M value
	B Value	Indicates the defined B value

**Deactivate MX+B measure**      To cancel the MX+B measurement, press the F1 (MX+B) key and toggle to Off to deactivate the function. 

# DIGITAL I/O

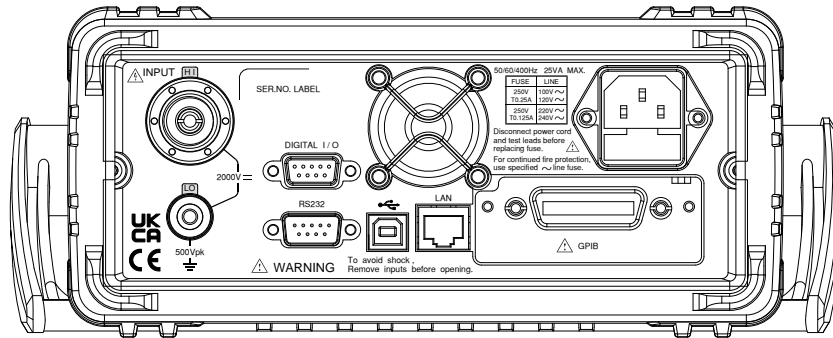

---

<b>Digital I/O Overview .....</b>	<b>55</b>
<b>Application: Compare Mode .....</b>	<b>57</b>
<b>Application: 4094 / User Mode .....</b>	<b>64</b>
User Mode – IO (Output) Mode .....	64
User Mode – Switch Mode (LED).....	66
User Mode – Switch Mode (Relay) .....	68
4094 Mode .....	70
<b>Application: External Trigger .....</b>	<b>72</b>

# Digital I/O Overview

**Background** The Digital I/O port is a triple function port. By default (Compare Mode) the port is used with the compare function to output Hi Fail, Lo Fail, Pass, and EOM (end of measurement) signals. In addition, there is also a TRIG IN input pin.

As a secondary function (4094 Mode) and third function (User Mode), the Digital I/O port can have the output state of pins 5 ~ 8 controlled via remote control.

By providing separate VCC power for the terminal, the outputs can also be used as a power source for TTL and CMOS circuits.

**Related Commands**

DIGital:INTerface:MODE ?

DIGital:INTerface:MODE {COMP | 4094 | IO}

DIGital:INTerface:DATA:OUTPut (For 4094 Mode)

DIGital:INTerface:DATA:SETup (For User Mode)

**Pin Assignment** Connector type: DB-9 female

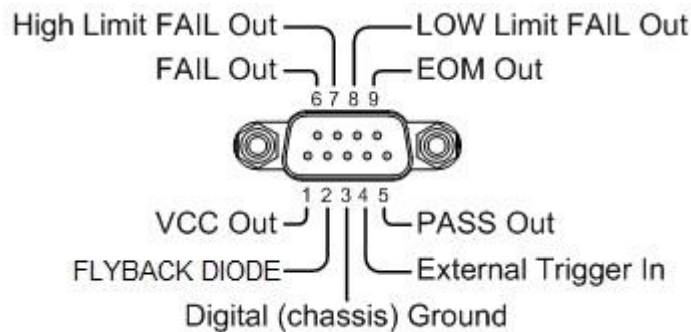
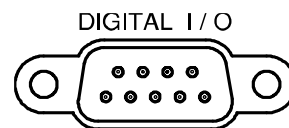

Pin No	Compare Mode	4094 Mode	User Mode
1	VCC Out	VCC Out	VCC Out
2	Flyback Diode	Flyback Diode	Flyback Diode
3	Digital Ground	Digital Ground	Digital Ground
4	External Trigger In	External Trigger In	External Trigger In

5	Pass Out	Clock	OUT1
6	Fail Out	Output Enable	OUT2
7	High Limit Fail Out	Strobe	OUT3
8	Low Limit Fail Out	Serial Input	OUT4
9	EOM Out	EOM Out	EOM Out

**Pin1** VCC output, 5 V. Serves as the unregulated max power source for the external device/logic.  
The maximum current is 100 mA.

**Pin2** Flyback Diode. Connect to VCC or External power source.

**Pin3** Digital (chassis) Ground.

**Pin4** External Trigger Input. Accepts external trigger signals. For using external signals.

Pins 3-4 output wiring diagram

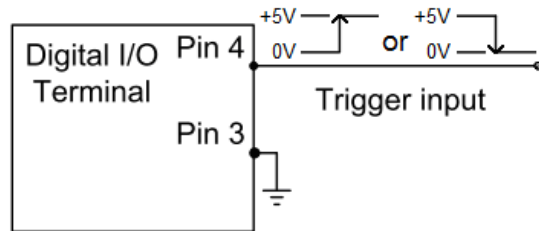

**Pin5-8** Pin 5-8 are designed as composite pins, which can be specified by user for diversified functions as follows:

Compare/4094/User Mdoe

Refer to the page 45 for details of Compare Mode, and the page 64 for details of 4094/User Mode.

Pins 5-8 output wiring diagram

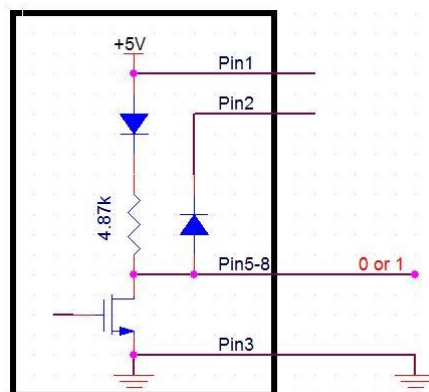



**Pin9** EOM (End Of Measurement) signal Output.  
 Activates when compare measurement is over.  
 It is also available in other measurements.

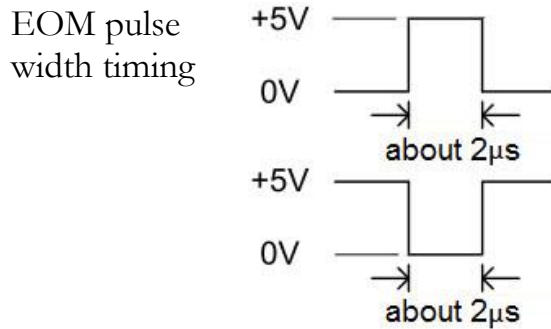

## Application: Compare Mode

**Background** The Compare Mode outputs the pass/fail results of the Compare function. Each signal is an active low signal. In addition, an active low pulse of approximately 2 µs is output to indicate the end of compare measurement (EOM).

When the input signal exceeds the high threshold or the low threshold, the High Fail or Low Fail pin is pulled low. When the signal stays within the threshold levels, the Pass pin is pulled low.

Pin Assignment	Pin No	Compare Mode	Description
	1	VCC Out	Option (Vcc)
	2	Flyback Diode	No Use
	3	Digital Ground	GND
	5	Pass	Out
	6	Fail	Out
	7	High Limit Fail	Out
	8	Low Limit Fail	Out

Activate Compare mode

Click the Compare key on the front panel followed by pressing the F1 (COMP) key to turn ON the Compare function. The screen, after activation, will appear as figure below.

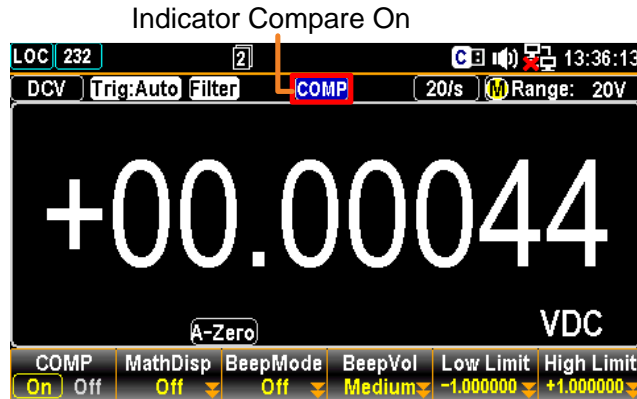

F6 (High Limit) to set high limit

Press the F6 (High Limit) key to enter the setting menu.



First use the functions keys to determine the unit, which varies by different measure modes. Then use the Left/Right arrow keys to move cursor and scroll the Knob key or press Number Keys to enter the desired value of high limit.

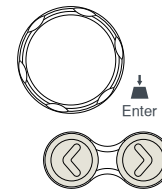

Push the F6 (Enter) key or the Knob key (Enter) to make the setting into effect.



F5 (Low Limit) to set low limit

Press the F5 (Low Limit) key to enter the setting menu.



First use the functions keys to determine the unit, which varies by different measure modes. Then use the Left/Right arrow keys to move cursor and scroll the Knob key or press Number Keys to enter the desired value of low limit.

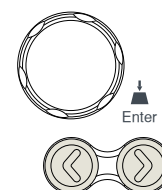

Push the F6 (Enter) key or the Knob key (Enter) to make the setting into effect.



**F3 (BeepMode) to define beep mode**

Press the F3 (BeepMode) key to enter the beep mode setting. By enabling beep mode, user can be aware of the latest state promptly by beep voice.

The display shows as the figure below. Press the F2 (Pass) or F3 (Fail) key to determine the condition of beep alarm.

Press the F1 (Off) key to disable beep mode.



**BeepMode**

**Pass**

or

**Fail**

**Off**

**F4 (BeepVol) to select beep volume**

Press the F4 (BeepVol) key to enter the beep volume setting.

Select the intensity of beep volume via pressing F1 – F3 key for desired level as the figure shown below.



**BeepVol**

**Small**

or

**Medium**

or

**Large**

Compare mode result

the measured result is within the range of high and low limit, the display shows as the figure below with purely black background indicating the state of “Pass”.

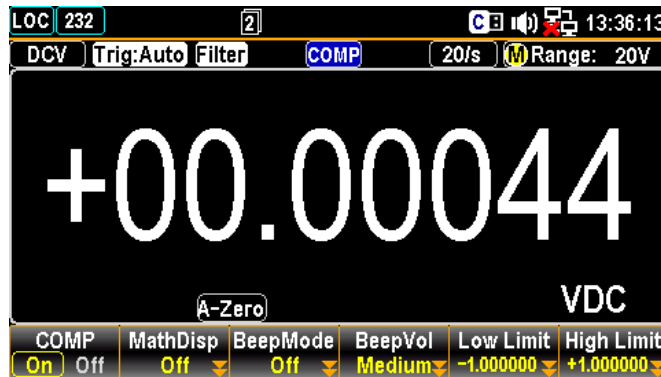

However, when measured result is either above or less than the limit range, the display appears as the figure below with boldly red background indicating the state of “Fail”.

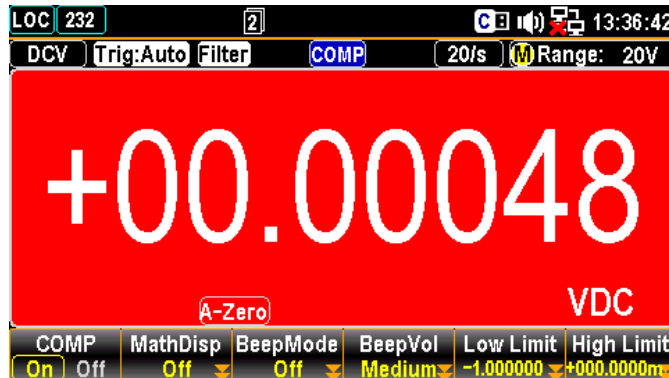

See the contents below for more details of each state in compare mode.

**High** If the compare result is High, the relative pins of digital I/O port in action are as the follows.

Digital I/O: FAIL Out (Pin 6) and HIGH Limit FAIL Out (Pin 7) are activated.

**Low** If the compare result is Low, the relative pins of digital I/O port in action are as the follows.

Digital I/O: FAIL Out (Pin 6) and LOW Limit FAIL Out (Pin 8) are activated.

**Pass** If the compare result is Pass, the relative pin of digital I/O port in action is as the follows.

Digital I/O: PASS Out (Pin 5) is activated.

F2 (MathDisp) key Press the F2 (MathDisp) key to show the Math Display menu as the figure below shown. Proceed to the F2 (STAT), F3 (Math) or F4 (Math+STAT) display in accord with the following chapters.



Show STAT result Background The STAT page in MathDisp allows you to make statistical calculations for several measurements including Minimum, Maximum, Average Peak-Peak, Standard Deviation and Count.

Operation Press the F2 (STAT) key **STAT** to show the statistical data as the figure below.

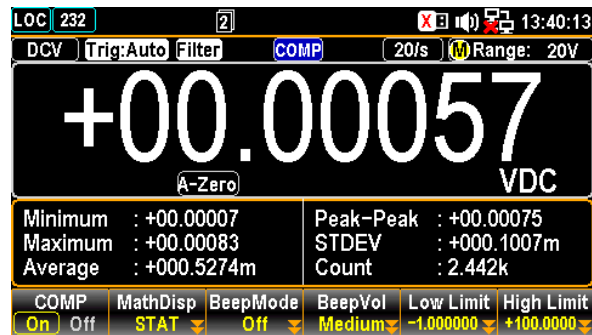

View Data	+00.00057 VDC	Indicates the currently measured VDC value
	Minimum	Indicates the minimum data value
	Maximum	Indicates the maximum data value
	Average	Indicates the mean (average) value
	Peak-Peak	Indicates the peak to peak data
	STDEV	Indicates the standard deviation of the data
	Count	Indicates the latest counts of compare

Show Math result Background The Math page in MathDisp allows you to view mathematical calculations for several parameters.

Operation Press the F3 (Math) key **Math** to show the mathematical analysis as the figure below.

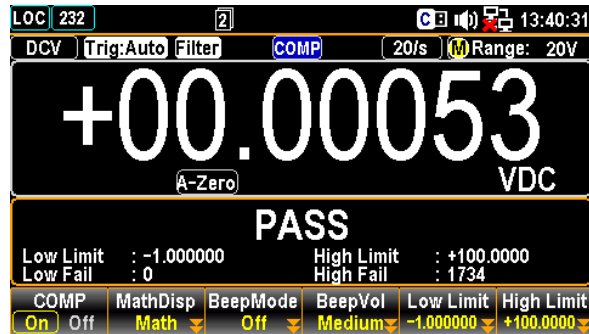

View Data	+00.00053 VDC	Indicates the currently measured VDC value
	Low Limit	Indicates the defined low limit
	Low Fail	Indicates the counts of below the defined low limit
	High Limit	Indicates the defined high limit
	High Fail	Indicates the counts of above the defined high limit

Show Math+STAT result

Background The Math+STAT page in MathDisp allows you to view data from both statistical calculations and mathematical analysis.

Operation Press the F4 (Math+STAT) key **Math+STAT** to show the hybrid page of Math & STAT instantly as figure below.

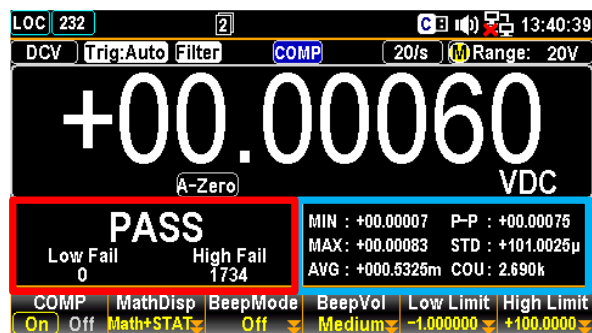

View Data	+00.00060 VDC	Indicates the currently measured VDC value
	Blue Section	It is identical to the contents of STAT display. Refer to the previous chapter for details.

Red Section It is identical to the contents of Math display. Refer to the previous chapter for details.

Compare live-result in MathDisp

The latest state of compare measurement, whether it's "Pass", "High" or "Low", will also appear within each mode of MathDisp. See the example below for the "High" result in Math+STAT mode.

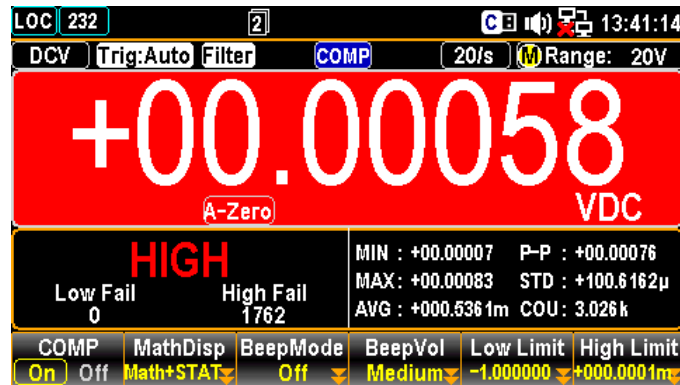

The boldly red background along with the indicator "HIGH" within the display means the compare result is over the range of defined high limit.

Timing Diagram for pins 5-8 when the Compare function is activated

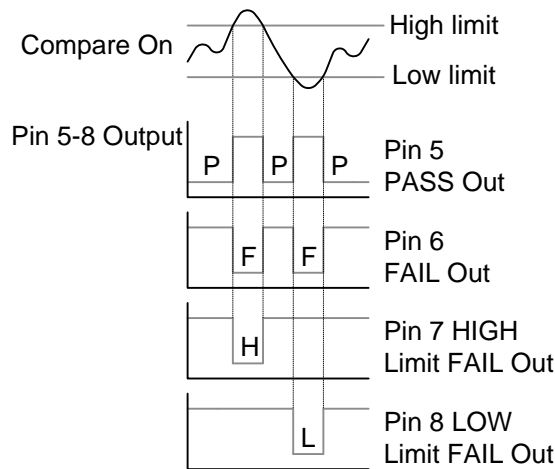

Deactivate Compare measurement

To cancel the Compare measurement, press the F1 (COMP) key and toggle to Off to deactivate the function.



## Application: 4094 / User Mode

**Overview** 4094 and User mode can only used when using a remote control interface. Likewise this mode can only be enabled or disabled via remote control. Please see the digital I/O commands on page 210 for full usage details.

### User Mode – IO (Output) Mode

**Overview** It is the mode utilizing output as general IO (Output) usage with up to 4 pins available for use simultaneously. Refer to the following introductions along with diagrams for more details. Please see the digital I/O commands on page 210 for full usage details.

**Related Commands** DIG:INT:MODE IO (switch to IO mode)  
 DIG:INT:DATA:SET 0,1,1,0  
 => OUT1 (Pin5) : +0 V  
       OUT2 (Pin6) : +5 V  
       OUT3 (Pin7) : +5 V  
       OUT4 (Pin8) : +0 V

Pin	Pin No	User Mode	Description
Assignment	1	VCC Out	Option (Vcc: +5 V)
	2	Flyback Diode	No Use
	3	Digital Ground	GND
	5	OUT1	Use
	6	OUT2	Use
	7	OUT3	Use
	8	OUT4	Use



Pin Diagram **\* Use the built-in power supply**

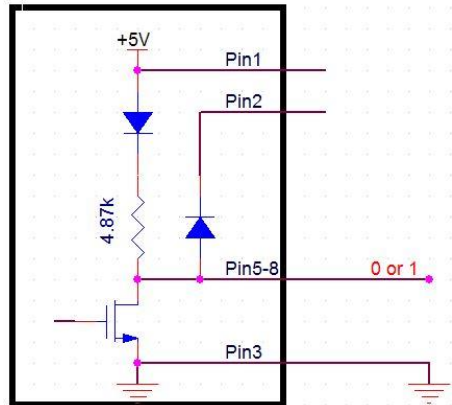

⚠ Note: Pin1 and Pin2 Not in use

**\* Use in conjunction with the logic gate**

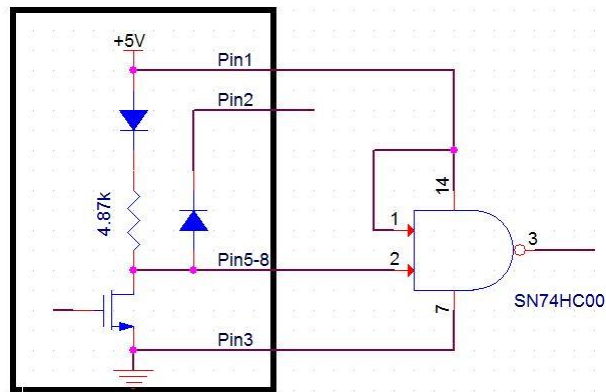

⚠ Note: Pin2 Not in use

## User Mode – Switch Mode (LED)

---

**Overview** It is the mode driving LED as status display for user with up to 4 pins available for use simultaneously. Refer to the following introductions along with diagrams for more details. Please see the digital I/O commands on page 210 for full usage details.

---

**Related Commands** DIG:INT:MODE IO (switch to IO mode)  
 DIG:INT:DATA:SET 1,0,0,1  
 => OUT1(Pin5) : LED OFF  
       OUT2(Pin6) : LED ON  
       OUT3(Pin7) : LED ON  
       OUT4(Pin8) : LED OFF

---

Pin	Pin No	User Mode	Description
Assignment	1	VCC Out	Option (Vcc: + 5V)
	2	Flyback Diode	No Use
	3	Digital Ground	Option (GND)
	5	OUT1	Use
	6	OUT2	Use
	7	OUT3	Use
	8	OUT4	Use

Pin Diagram

**\* Use the built-in power supply**

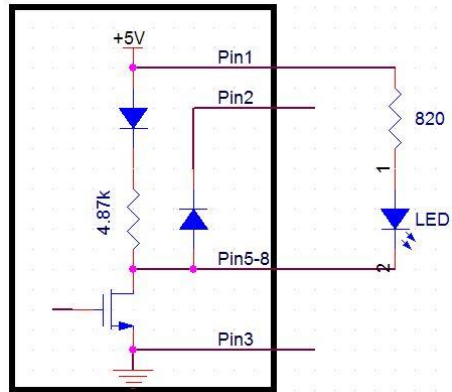

Note:

Pin2 and Pin3 Not in use

**\* Use the external power**

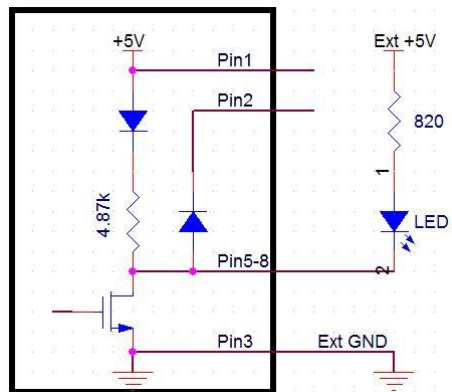

Note:

Pin1 and Pin2 Not in use

## User Mode – Switch Mode (Relay)

**Overview** It is the mode driving Relay to control external circuit with up to 4 pins available for use simultaneously. Refer to the following introductions along with diagrams for more details. Please see the digital I/O commands on page 210 for full usage details.

**Related Commands** DIG:INT:MODE IO (switch to IO mode)  
 DIG:INT:DATA:SET 1,0,1,0  
 => OUT1 (Pin5) : RELAY OFF  
       OUT2 (Pin6) : RELAY ON  
       OUT3 (Pin7) : RELAY OFF  
       OUT4 (Pin8) : RELAY ON

Pin	Pin No	User Mode	Description
Pin Assignment	1	VCC Out	Option (Vcc: +5 V)
	2	Flyback Diode	Use (connect to Pin1 or Ext Vcc)
	3	Digital Ground	GND
	5	OUT1	Use
	6	OUT2	Use
	7	OUT3	Use
	8	OUT4	Use

Pin Diagram

**\* Use the built-in power supply which provides the power of maximum 100mA**

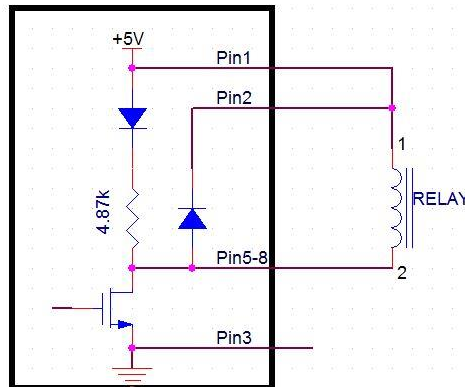

**!** Note:  
Pin3 Not in use

**\* Use the external power (+5~24V) (Maximum Ids of each channel: 400mA)**

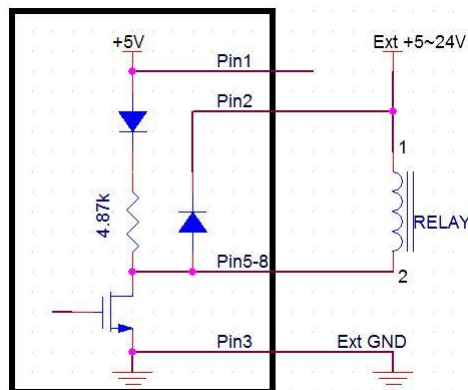

**!** Note:  
Connect Pin2 to Ext Vcc

## 4094 Mode

**Overview** It is the mode for IO expansion via converting serial data into parallel data. Up to 8 pins are available simultaneously when single 4094 is in operation, whereas it rises to the maximum of 16 pins available simultaneously if putting two 4094 in series. Refer to the following introductions along with diagrams for more details. Please see the digital I/O commands on page 210 for full usage details.

**Related Commands** DIG:INT:MODE 4094 (switch to 4094 mode)

**4094 x 1(8 Pin)**

DIG:INT:DATA:OUTP 10 , 1

=> 4094 Output(Out1~Out8) : 01010000

**4094 x 2(16 Pin)**

DIG:INT:DATA:OUTP 22,0

DIG:INT:DATA:OUTP 88,1

=> 4094 Output(Out1~Out8) : 01101000

(Out9~Out16): 00011010

 **Note:** 0=> output is Low (+0 V); 1=> output is High (+5 V)

Pin	Pin No	4094 Mode	Description
Assignment	1	VCC Out	Option (Vcc: +5 V)
	2	Flyback Diode	Option (connect to Pin1)
	3	Digital Ground	GND
	5	Clock	Use
	6	Output Enable	Option (connect to Vcc when not in use)
	7	Strobe	Use
	8	Serial Input	Use

Pin Diagram

**\* Use the built-in power supply**

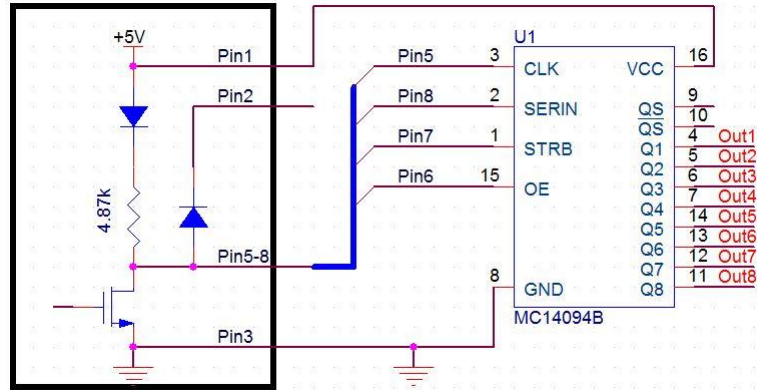

⚠ Note: Pin2 Not in use

**\* Use the external power**

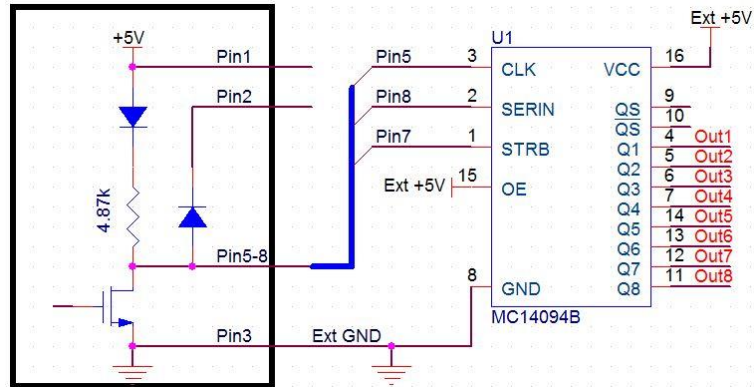

⚠ Note: Pin1 and Pin2 Not in use

**\* Method of series**

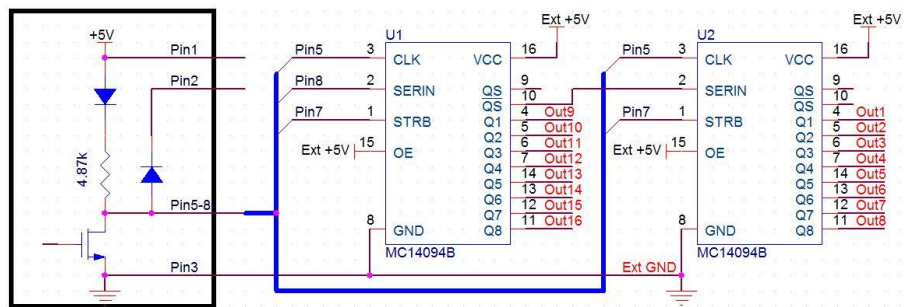

⚠ Note: Pin1 and Pin2 Not in use

# Application: External Trigger

**Background** The external trigger uses the digital I/O pin for manual triggering of the GVM-9102. To trigger the GVM-9102 a pulse of  $\geq 10 \mu\text{s}$  is needed.

The READ? command can also be used to externally trigger the GVM-9102 when the GVM-9102 is in the external trigger mode. See page 202 for details.

**Signal connection** Connect the external trigger signal to the Digital I/O port located on the rear panel.

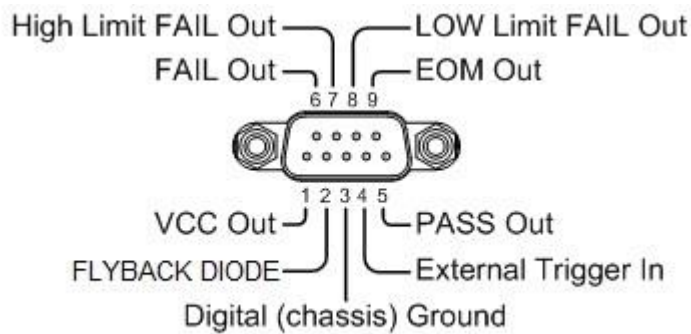

**Pin4** External Trigger Input pin

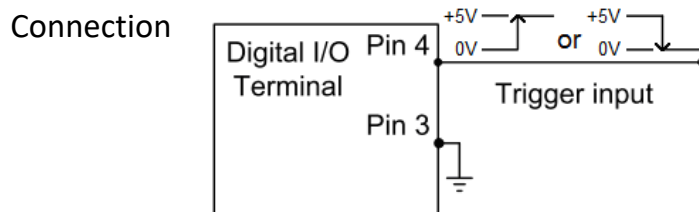



Activate external trigger

Press the Shift + TRIG key to activate setting menu of trigger.

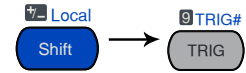

Press the F1 (TrigSource) key to enter the trigger source menu followed by pressing the F3 (EXT) to select External Trigger mode.

**TrigSource**



**EXT**

The “EXT” indicator appears on the display.

External Trigger Mode

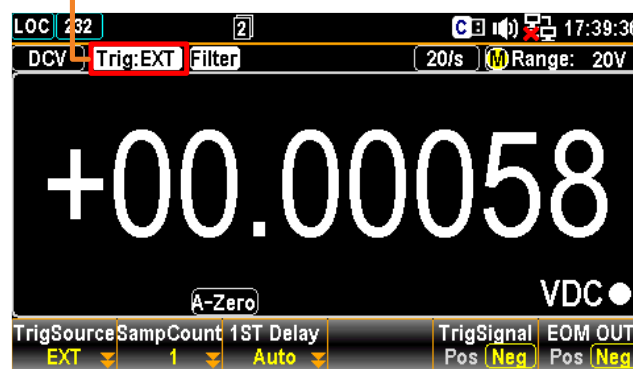

Reading indicator

The reading indicator  does not flash before triggering (can be on or off). After triggering, the indicator flashes according to the external signal trigger timing.

Exit external trigger

Press the Shift key followed by the TRIG key. The EXT indicator disappears and the trigger goes back to internal mode.

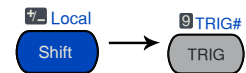

# **S**YSTEM & FIRMWARE

---

<b>View System Info .....</b>	<b>75</b>
<b>Firmware Update .....</b>	<b>76</b>

# View System Info

**Background** View system information including Vendor, Model Name, Serial Number, Master Firmware and Slave Firmware.

- Step**
1. Press the Menu key, the System configuration menu appears. And press the NEXT key repeatedly or scroll the Knob key to move to the Security&Info – SystemInfo field.

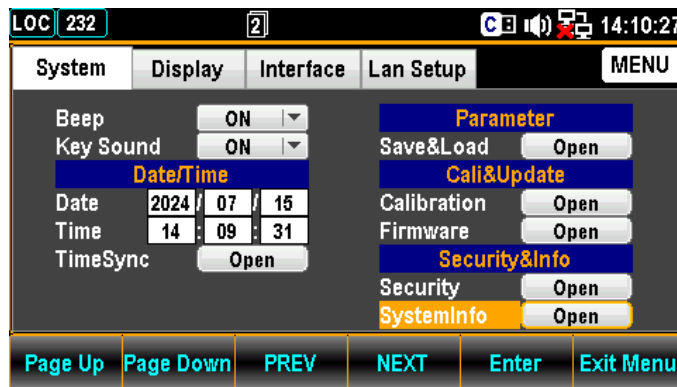
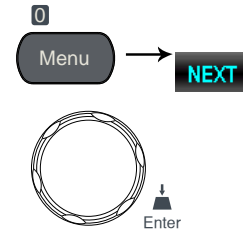

2. Press the F5 (Enter) key or Knob key to enter the System Information where all the critical contents are exposed for check.



# Firmware Update

**Background** This section is for updating the latest firmware.

- Step**
1. Press the Menu key, the System configuration menu appears. And press the NEXT key repeatedly or scroll the Knob key to move to the Cali&Update - Firmware field.

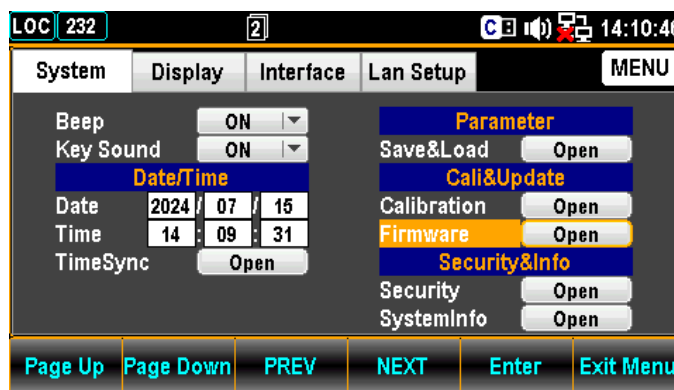
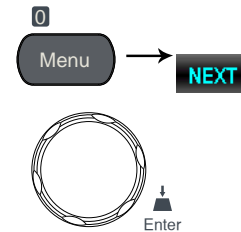

2. Press the F5 (Enter) key or Knob key to enter the Firmware Update menu.



Firmware Update	Update Process	<p>Prior to update, make sure if the required firmware file is stored within the flash drive plugged into the USB port on the front panel. Also, user can check the current Master and Slave firmware version respectively in this menu.</p>
-----------------	----------------	--

-  **Note** Prior to update, please rename the downloaded firmware files as below:
- ✓ Master file: M\_IMAGE.bin
  - ✓ Slave file: S\_IMAGE.bin

1. Press the F5 (Enter) key or Knob key first, the qualified firmware version will show then.



Note: If flash drive has no update files, it will show as the figure below.



2. Press the NEXT key or scroll Knob key to move to the Update followed by pressing the F5 (Enter) key or Knob key to Start update.



# MENU SETTING

---

<b>Configure System</b> .....	<b>79</b>
Beep Setting .....	79
Key Sound Setting .....	80
Date Setting.....	81
Time Setting .....	82
TimeSync Setting .....	83
Save and Load Setting .....	84
Calibration Setting .....	89
Firmware Update .....	90
Security Setting.....	92
View System Info .....	95
<b>Configure Display</b> .....	<b>96</b>
Brightness Setting .....	96
Auto Off Setting .....	97
Auto Off Time Setting.....	98
1ST Color Setting .....	100
Math Color Setting.....	102
Display Mode Setting .....	104
Anti Aliasing Setting .....	109
Additional Info Setting .....	110
Language Setting .....	112

# Configure System

## Beep Setting

Background Enable or Disable Beep Sound.

- Step 1. Press the Menu key, the System configuration menu appears.

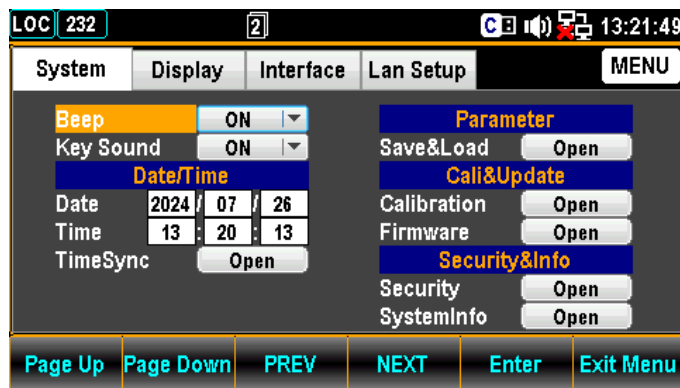

2. Press the F5 (Enter) key or Knob key followed by scrolling Knob key or pressing +/- keys to land on the ON option.

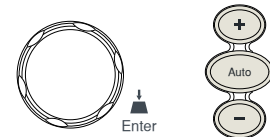

Enter

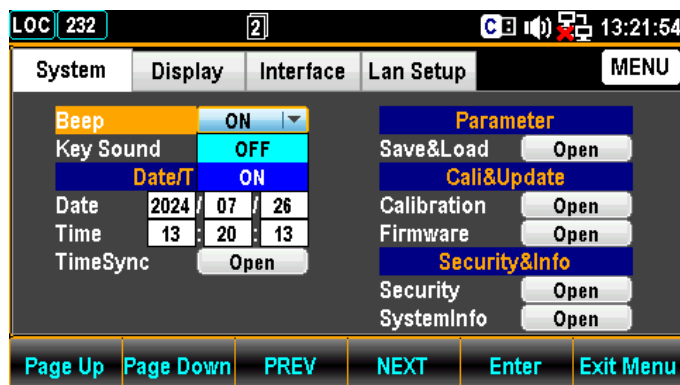

3. Press the F5 (Enter) key or Knob key to select the ON option.

Enter



## Key Sound Setting

Background Enable or Disable Key Sound.

- Step 1. Press the Menu key, the System configuration menu appears. And then press the NEXT key repeatedly or scroll the Knob key to move to the Key Sound field.

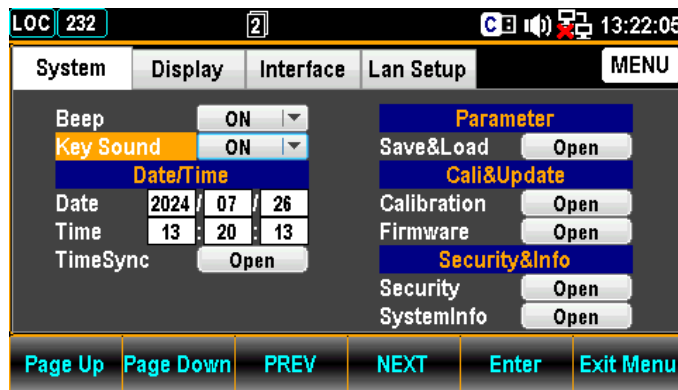
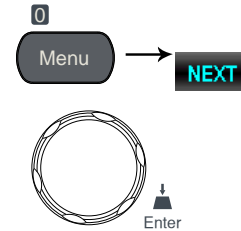

2. Press the F5 (Enter) key or Knob key followed by scrolling Knob key or pressing +/- keys to land on the On option.

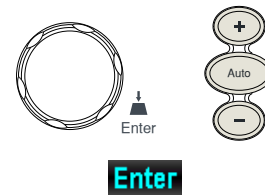

**Enter**

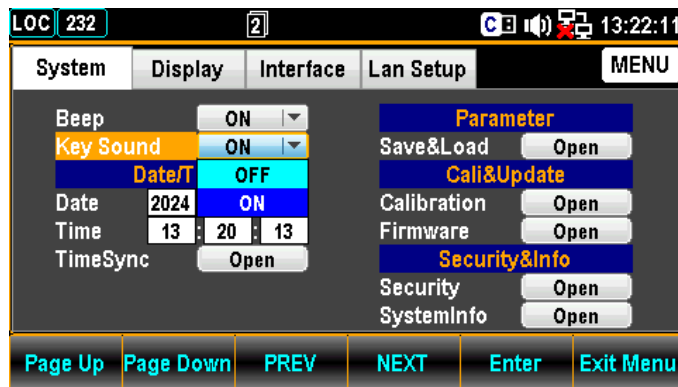

3. Press the F5 (Enter) key or Knob key to select the ON option for Key Sound.



**Enter**



## Date Setting

**Background** Manually adjust date for system or automatically set date via TimeSync setting.

- Step**
1. Press the Menu key, the System configuration menu appears. And press the NEXT key repeatedly or scroll the Knob key to move to the Date/Time - Date field.

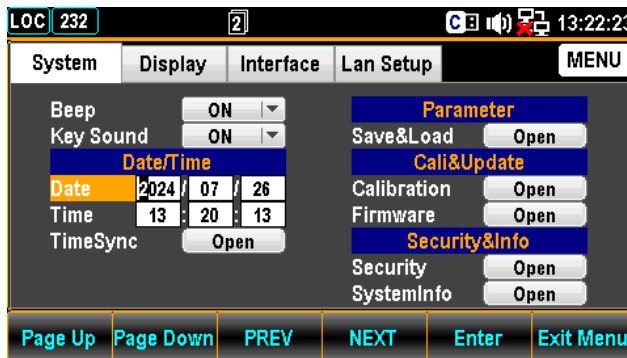
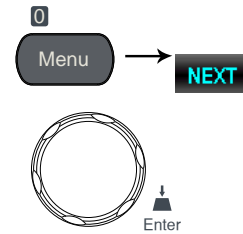

2. Use the Left/Right keys to move the cursor followed by scrolling Knob key or pressing +/- keys to define year of Date. Also, you can press Number keys to directly input a specific digit.

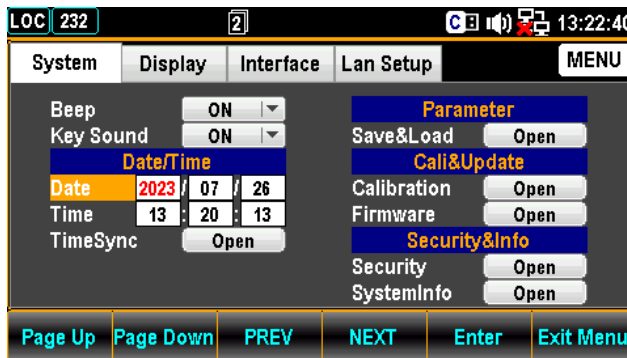
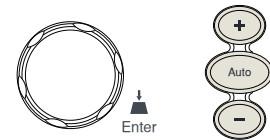

3. Press the F5 (Enter) key or Knob key to confirm the input digit for year of Date.



4. Repeat steps 2 to 3 for month and day.

## Time Setting

**Background** Manually adjust time for system or automatically set time via TimeSync setting.

- Step**
1. Press the Menu key, the System configuration menu appears. And press the NEXT key repeatedly or scroll the Knob key to move to the Date/Time - Time field.

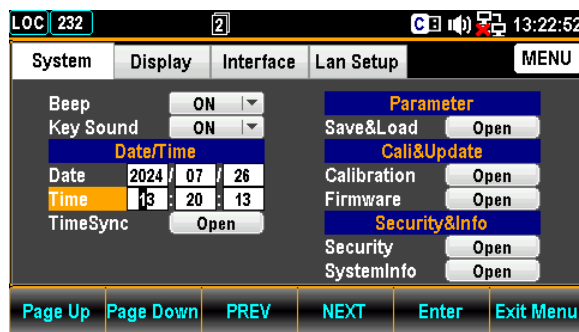
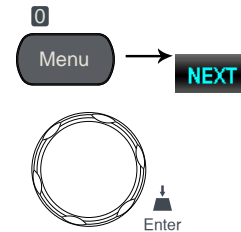

2. Use the Left/Right keys to move the cursor followed by scrolling Knob key or pressing +/- keys to define hour of Time. Also, you can press Number keys to directly input a specific digit.

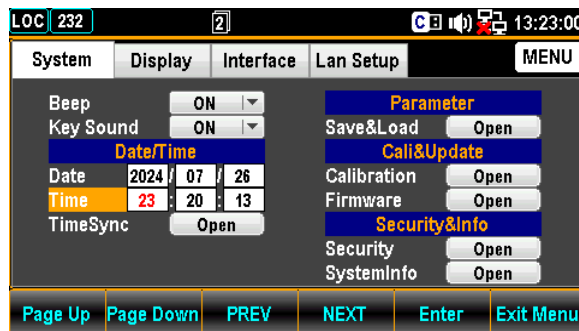
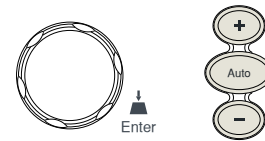

3. Press the F5 (Enter) key or Knob key to confirm the input digit for hour of Time.



4. Repeat steps 2 to 3 for minute and second.

## TimeSync Setting

**Background** TimeSync is only available when connecting to internet with appropriate network setting.

- Step**
1. Press the Menu key, the System configuration menu appears. And press the NEXT key repeatedly or scroll the Knob key to move to the Date/Time - TimeSync field.

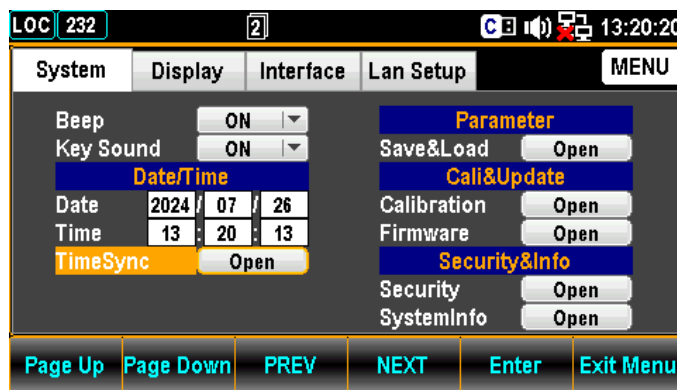
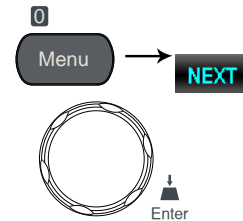

2. Press the F5 (Enter) key or Knob key to enter the Internet Time Sync menu.

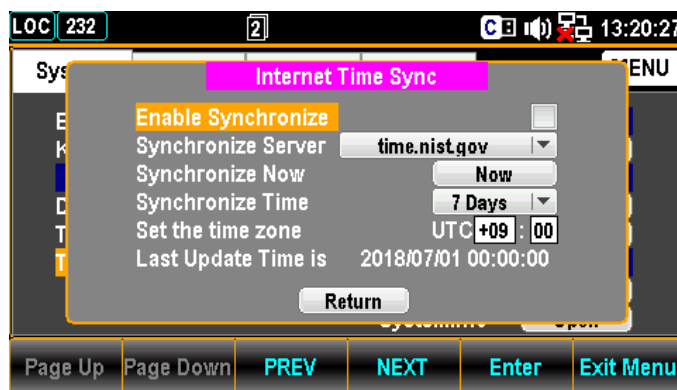

**Internet Time Synchronize** Enable Synchronize      Enable or disable time sync  
 Check / Uncheck

Synchronize Server      Choose remote server for time sync

	time.nust.gov / time-nw.nist.gov The 2nd server is available for user customization. Refer to page 203 for SCPI setting.
Synchronize Now	Retrieve the currently standard time from the remote sever.
Synchronize Time	Define an interval to retrieve the currently standard time from the remote sever.  7 Days / 14 Days / 30 Days
Set the time zone	Set UTC (Coordinated Universal Time)  hour / minute
Last Update Time is	Display the currently standard time.

## Save and Load Setting

**Background** The GVM-9102 can save up to 5 instrument settings. The settings can save the state, function, I/O and range. The Recall function enables saved settings or default settings to be recalled at the next power up or immediately.

- Step**
1. Press the Menu key, the System configuration menu appears. And press the NEXT key repeatedly or scroll the Knob key to move to the Parameter – Save&Load field.

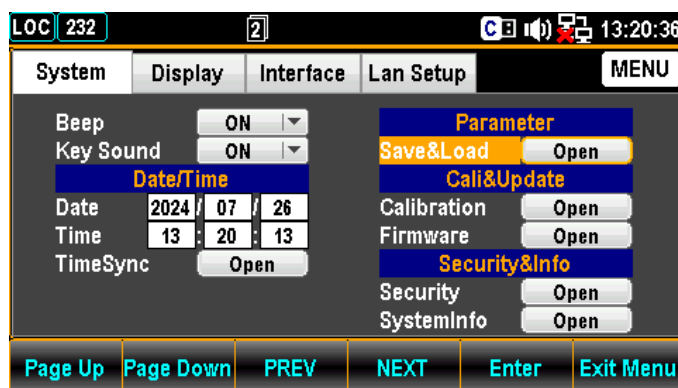
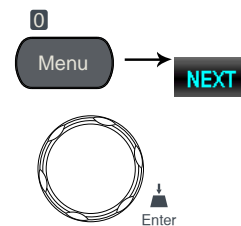

2. Press the F5 (Enter) key or Knob key to enter the Parameter Save&Load menu.

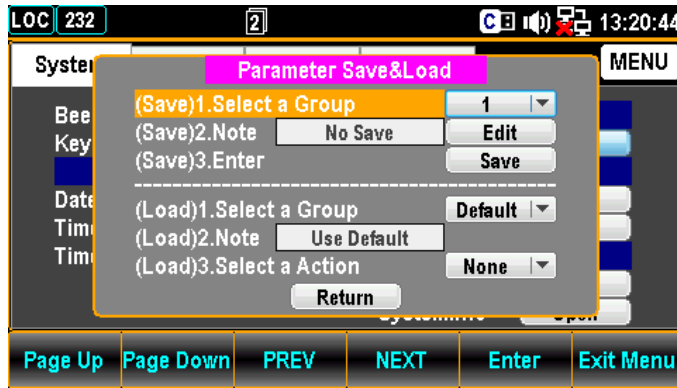
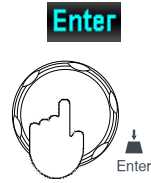

Parameter Save&Load

Save

- Select a Group
1. Press the F5 (Enter) key or Knob key to open the dropdown menu.

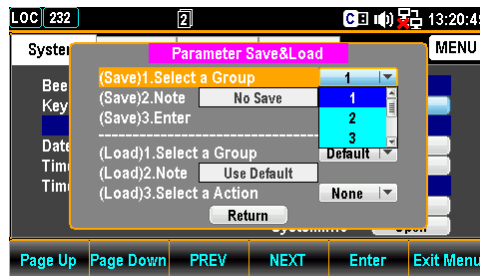

2. Scroll the Knob key or pressing +/- keys followed by pressing the F5 (Enter) key or Knob key to confirm the group selection.

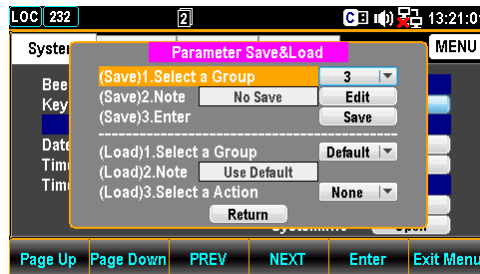
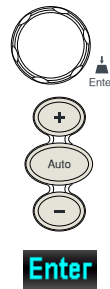

- Note
1. Press the F5 (Enter) key or Knob key to open the KeyBoard page.



2. Press the F2 (Backspace) key to clear default words.



3. Use the Left/Right and +/- keys or scroll the Knob key to move the cursor to desired word followed by pressing the F5 (Input) key or Knob key to input the word.

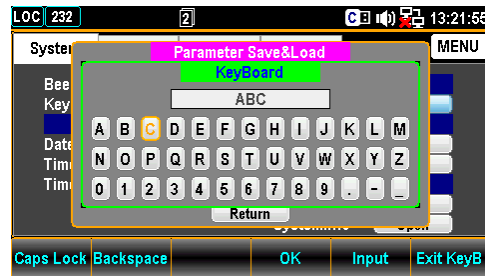
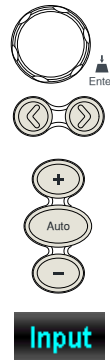

4. Press the F4 (OK) or the Knob key to confirm the input words.

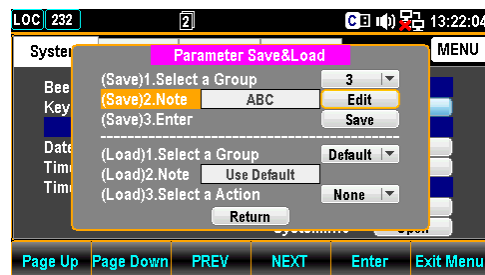

- Enter 3. Press the F5 (Enter) key or Knob key to saved the input words.

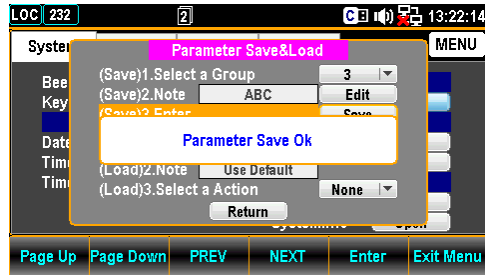

## Load

- Select a Group 1. Press the F5 (Enter) key or Knob key to open the dropdown menu.

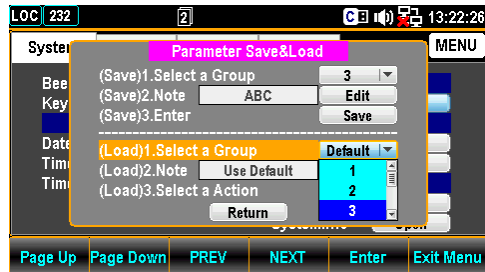

2. Scroll the Knob key or press +/- keys followed by pressing the F5 (Enter) key or Knob key to confirm the group selection.

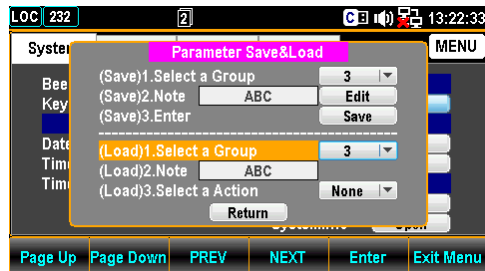
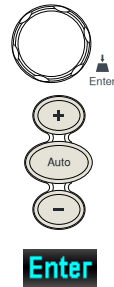

- Note 1. The currently selected group name appears in the Note field.

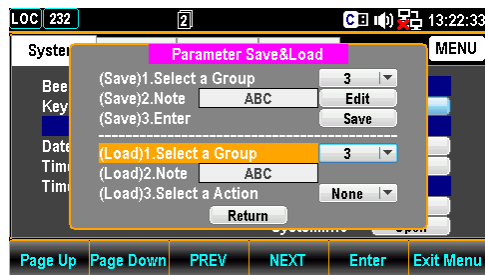

- Select a Action
1. Press the F5 (Enter) key or Knob key to open the dropdown menu.

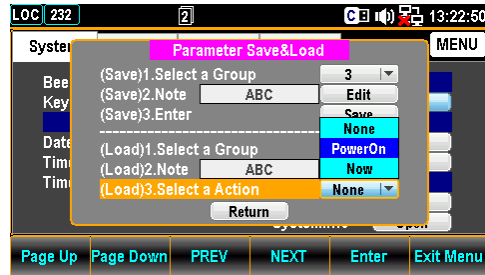

2. Scroll the Knob key or press +/- keys followed by pressing the F5 (Enter) key or Knob key to confirm the action selection.

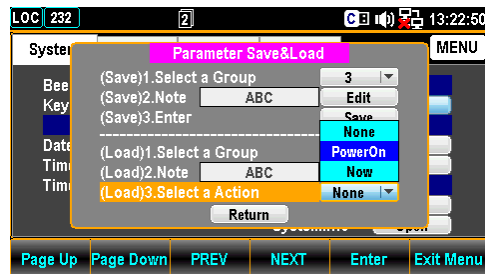
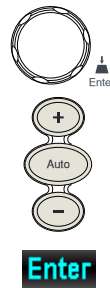

3. Press the F5 (Enter) key or Knob key to confirm the action selection.

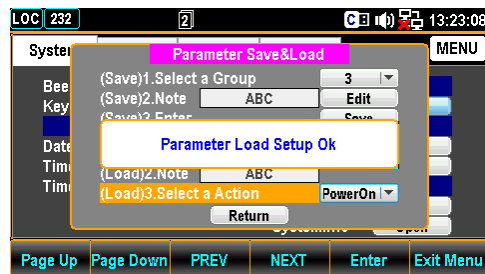

Parameter	None: no recall action
	Power On: recall at next power up
	Now: recall instantly



## Calibration Setting

**Background** This section mainly provides several calibrations for frequency, DC gain and DMM. Note that only the certified technician can operate the calibration procedure. Refer to the qualified personnel for more details when necessary.

- Step**
1. Press the Menu key, the System configuration menu appears. And press the NEXT key repeatedly or scroll the Knob key to move to the Cali&Update - Calibration field.

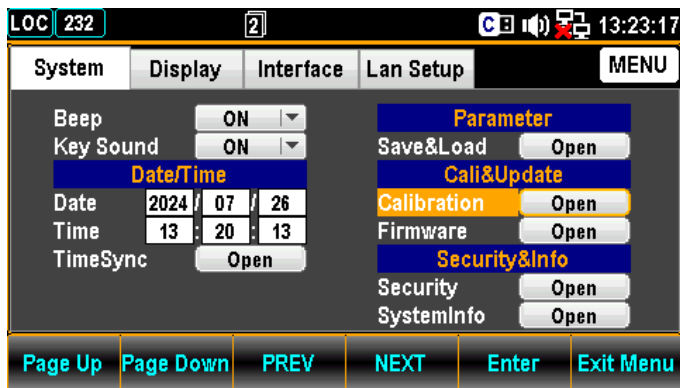
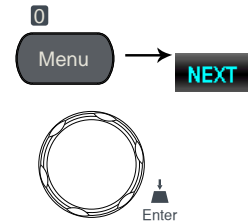

2. Press the F5 (Enter) key or Knob key to enter the Calibration menu.

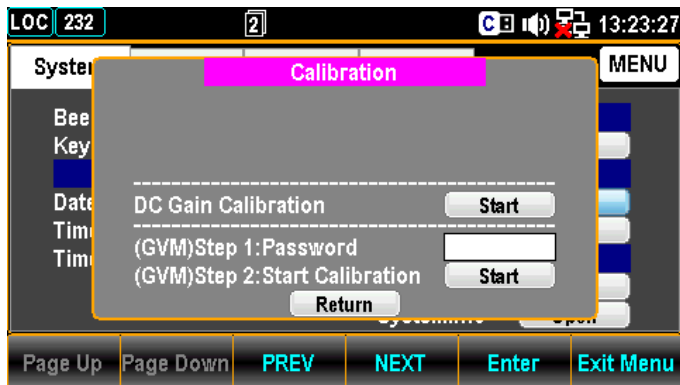

DC Gain Calibration	DC Gain Calibration	Click “Start” to execute DC Gain Calibration, which is an internally self-calibration function that does Not require external signal source. It corrects the gain of internal amplifier, though it is not necessary for general conditions unless the significant change in the gain of internal amplifier. It is suggested performing this calibration one time monthly.
---------------------	---------------------	---

DMM Calibration	 <b>NOTE</b>	The calibration procedure can be only executed by the certified technician in accordance with the standard instruments. Refer to the manufacturer or qualified personnel of authorized dealer for details.
-----------------	---	--

## Firmware Update

**Background** This section is for updating the latest firmware.

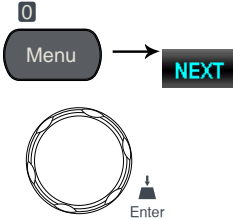
<b>Step</b>	1. Press the Menu key, the System configuration menu appears. And press the NEXT key repeatedly or scroll the Knob key to move to the Cali&Update - Firmware field.	
-------------	---	---

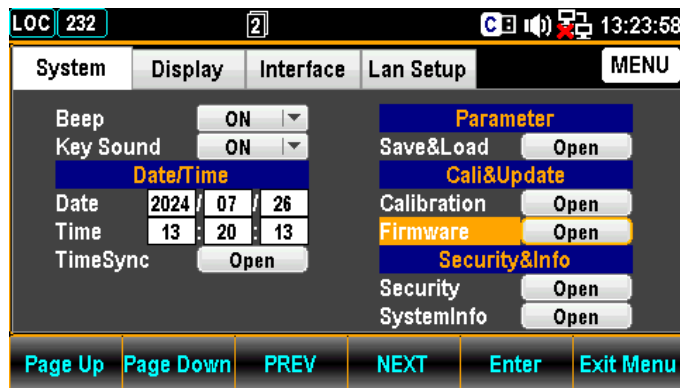

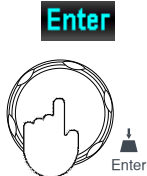
2. Press the F5 (Enter) key or Knob key to enter the Firmware Update menu.	
--	---

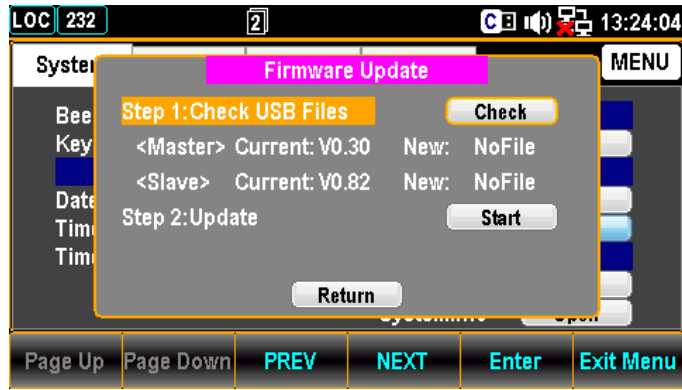

Firmware Update

Update Process

Prior to update, make sure if the required firmware file is stored within the flash drive plugged into the USB port on the front panel. Also, user can check the current Master and Slave firmware version respectively in this menu.

1. Press the F5 (Enter) key or Knob key first, the qualified firmware version will show then.



Note: If flash drive has no update files, it will show as the figure below.



2. Press the NEXT key or scroll Knob key to move to the Update followed by pressing the F5 (Enter) key or Knob key to Start update.



## Security Setting

**Background** This section is to change the password and enable or disable Lan password.

1. Press the Menu key, the System configuration menu appears. And press the NEXT key repeatedly or scroll the Knob key to move to the Security&Info – Security field.

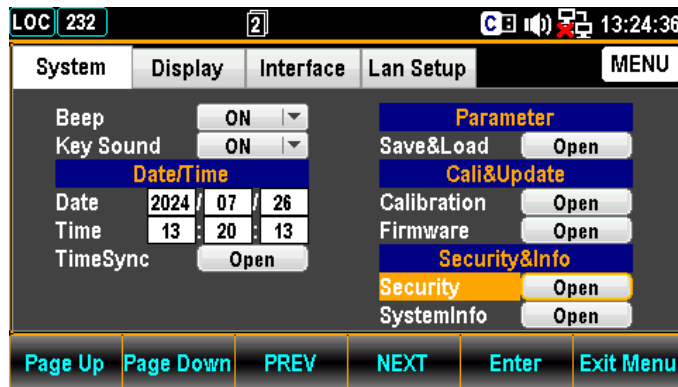

3. Press the F5 (Enter) key or Knob key to enter the Please Input Password page.



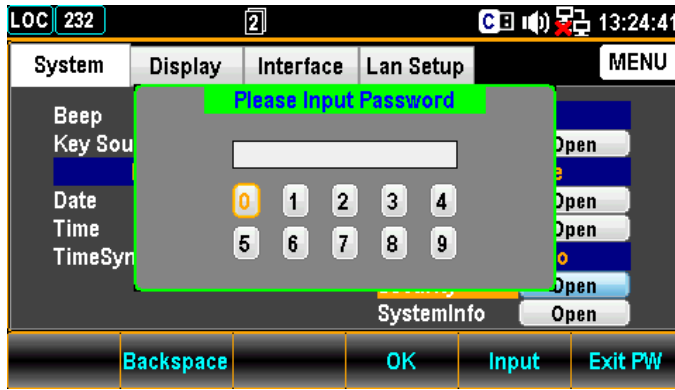

- Use the Left/Right and +/- keys or scroll the Knob key to move the cursor followed by pressing the F5 (Input) key or the Knob key to input the password.

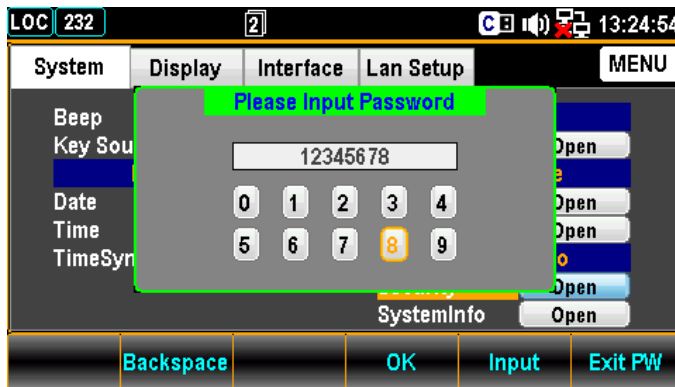
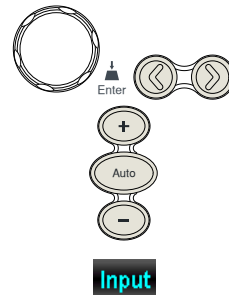

- Press the F4 (OK) key or Knob key to enter the Security page.

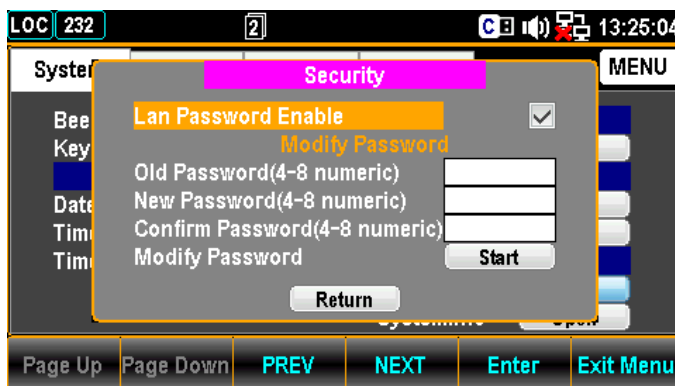
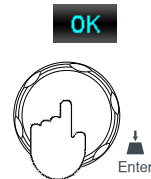

---

Security	Lan Password Enable	Enable or disable password requirement for Lan web and telnet Control. Check / Uncheck
	Old Password	Enter the old password
	New Password	Enter the new password
	Confirm Password	Enter the new password again
	Modify Password	Change password by clicking Start

---

## View System Info

**Background** View system information including Vendor, Model Name, Serial Number, Master Firmware and Slave Firmware.

- Step**
1. Press the Menu key, the System configuration menu appears. And press the NEXT key repeatedly or scroll the Knob key to move to the Security&Info – SystemInfo field.

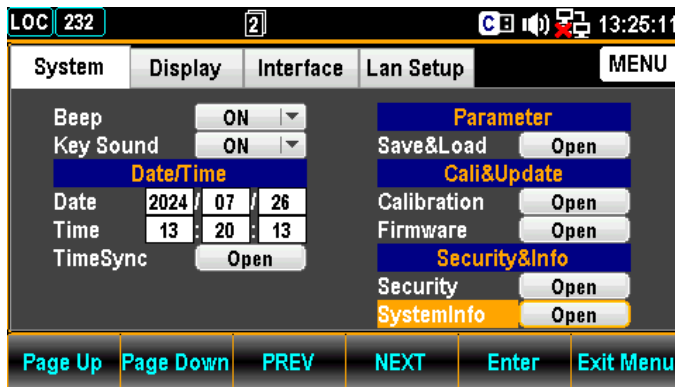
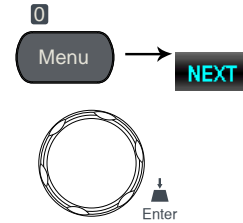

2. Press the F5 (Enter) key or Knob key to enter the System Information where all the critical contents are exposed for check.

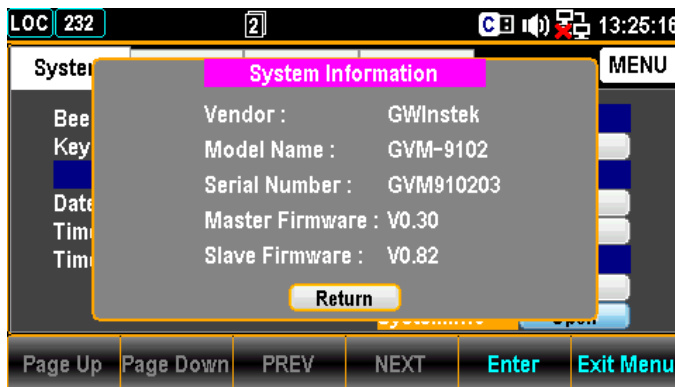

# Configure Display

## Brightness Setting

Background Backlight brightness adjustment

- Step 1. Press the Menu key followed by pressing the Page Down key repeatedly until the Display configuration menu appears.

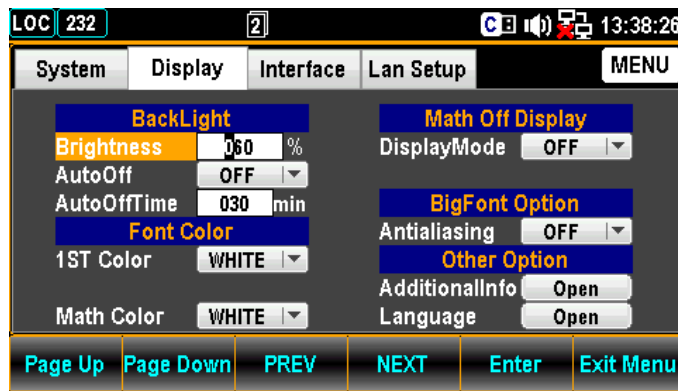
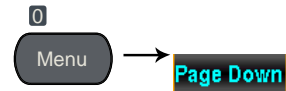

2. Use the Left/Right keys to move the cursor followed by scrolling Knob key or pressing +/- keys to define digit. Also, you can press Number keys to directly input a specific digit.

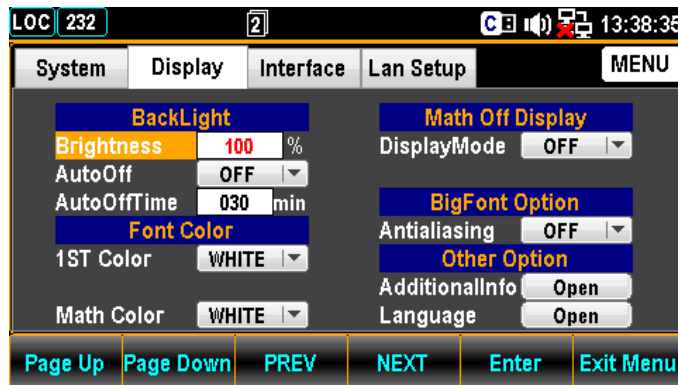
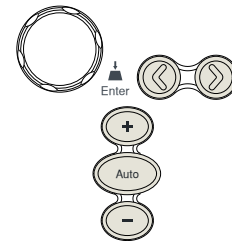



- Press the F5 (Enter) key or Knob key to confirm the input digit for backlight brightness.

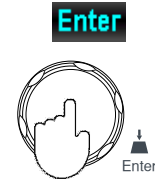

## Auto Off Setting

**Background** Enable or disable automatic brightness adjustment

- Press the Menu key followed by pressing the Page Down key repeatedly until the Display configuration menu appears.

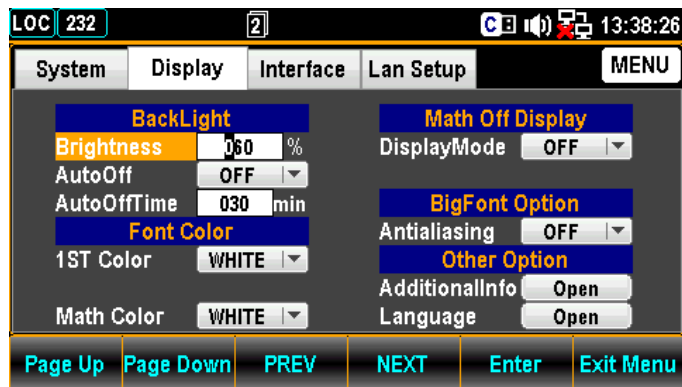

- Press the NEXT key repeatedly or scroll the Knob key to move to the BackLight - AutoOff field.

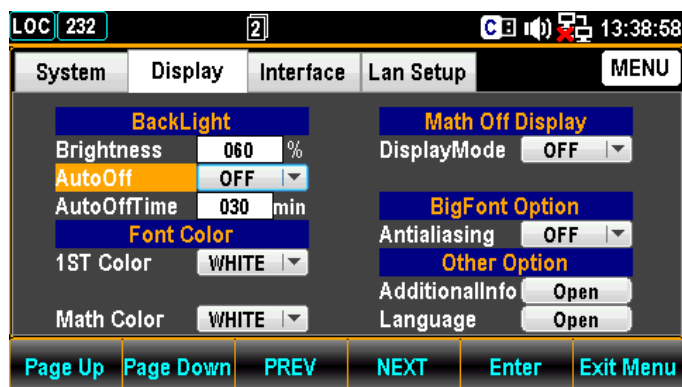

3. Press the F5 (Enter) key or Knob key followed by scrolling Knob key or pressing +/- keys to select the ON option.

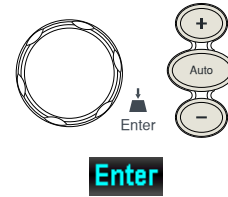

Enter

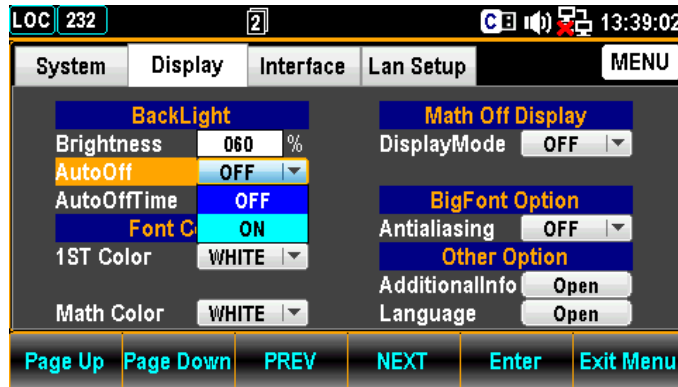

4. Press the F5 (Enter) key or Knob key to confirm the ON option for AutoOff.



Enter

## Auto Off Time Setting

### Background

Set the duration before automatic brightness adjustment. When the machine has been idle for the set duration, the screen will change to automatic brightness adjustment.

**NOTE:** Auto Off Time will be activated only when Auto Off option is turned ON.

### Step

1. Press the Menu key followed by pressing the Page Down key repeatedly until the Display configuration menu appears.

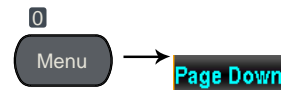

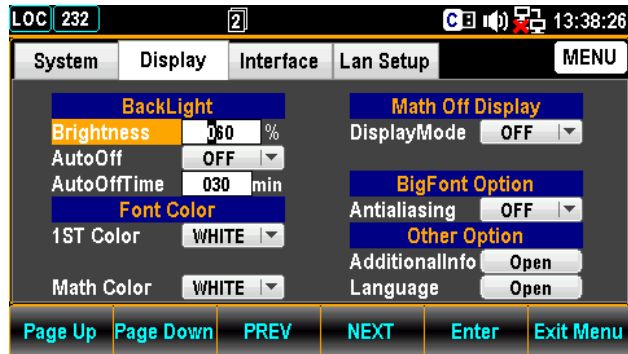

2. Press the NEXT key repeatedly or scroll the Knob key to move to the BackLight – AutoOffTime field.

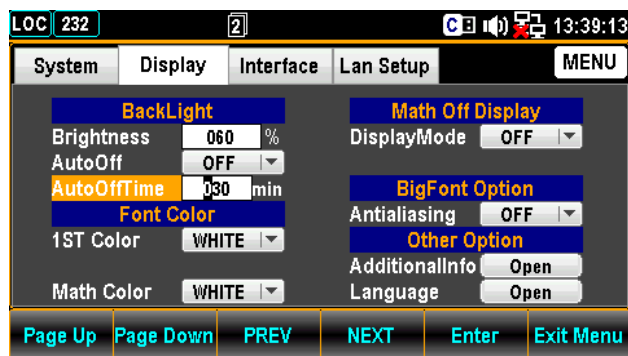

3. Use the Left/Right keys to move the cursor followed by scrolling Knob key or pressing +/- keys to define minutes. Also, you can press Number keys to directly input a specific minute.

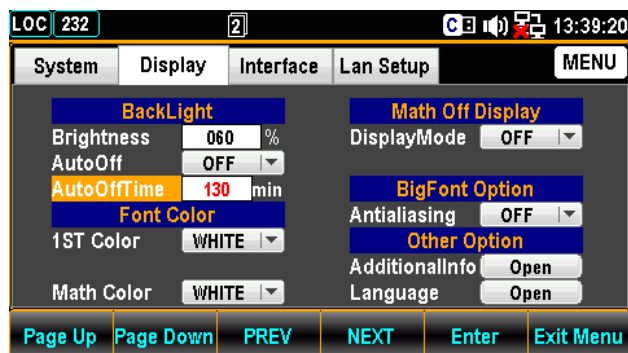
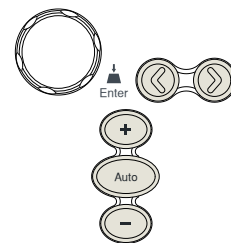

4. Press the F5 (Enter) key or Knob key to confirm the input minutes for Auto Off Time.



## 1ST Color Setting

**Background** Set the theme color of 1ST display

- Step**
1. Press the Menu key followed by pressing the Page Down key repeatedly until the Display configuration menu appears.

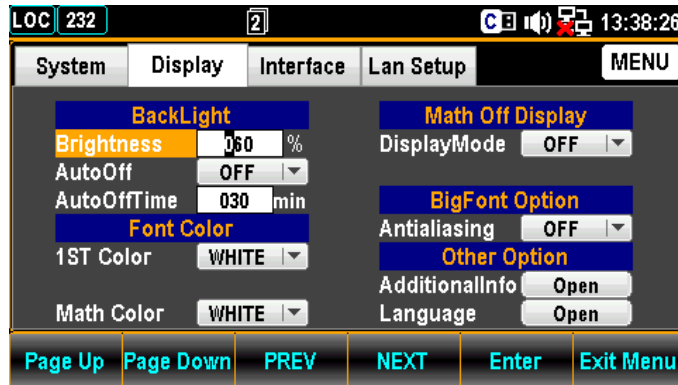
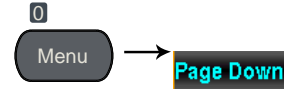

2. Press the NEXT key repeatedly or scroll the Knob key to move to the Font Color – 1ST Color field.

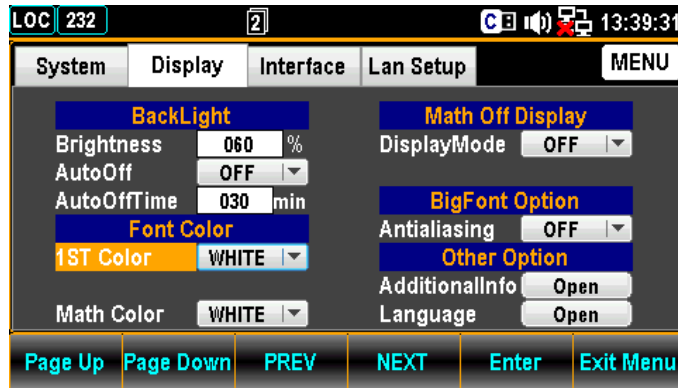

3. Press the F5 (Enter) key or Knob key followed by scrolling Knob key or pressing +/- keys to select desired color for 1ST display.

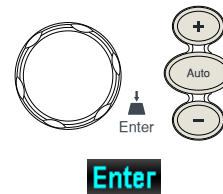

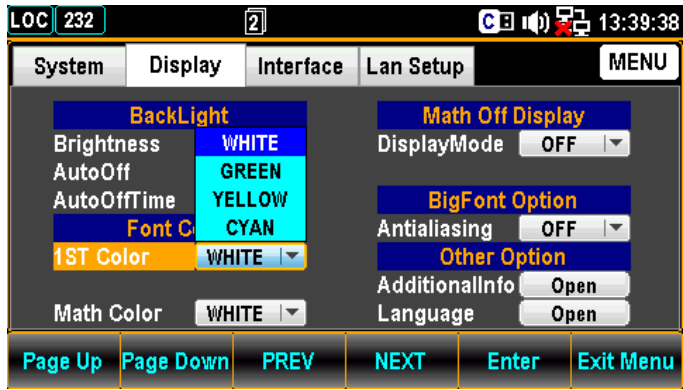

4. Press the F5 (Enter) key or Knob key to confirm the selected color.

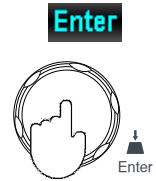

Display result

The following figure demonstrates the defined yellow color for 1ST display.

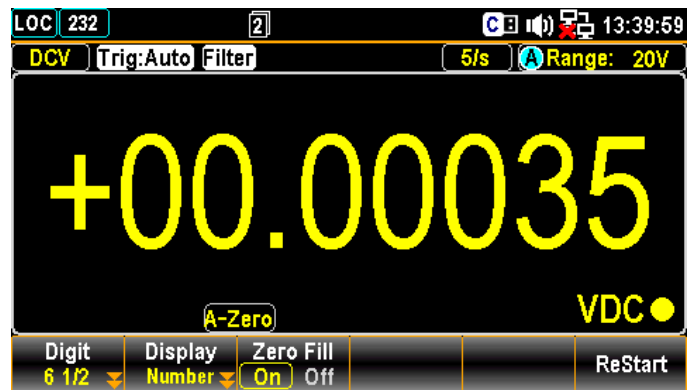

## Math Color Setting

**Background** Set the theme color of Math functions

- Step**
1. Press the Menu key followed by pressing the Page Down key repeatedly until the Display configuration menu appears.

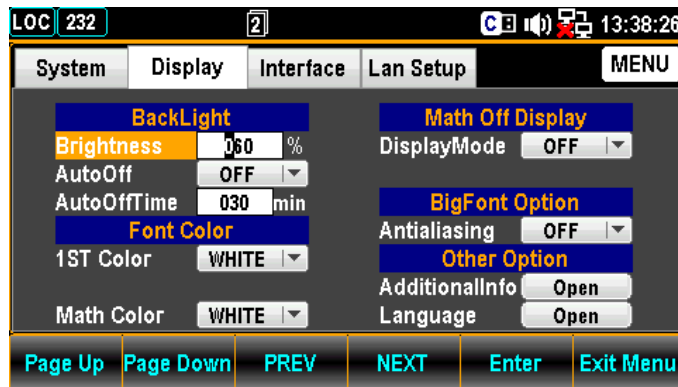
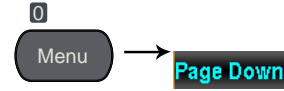

2. Press the NEXT key repeatedly or scroll the Knob key to move to the Font Color – Math Color field.

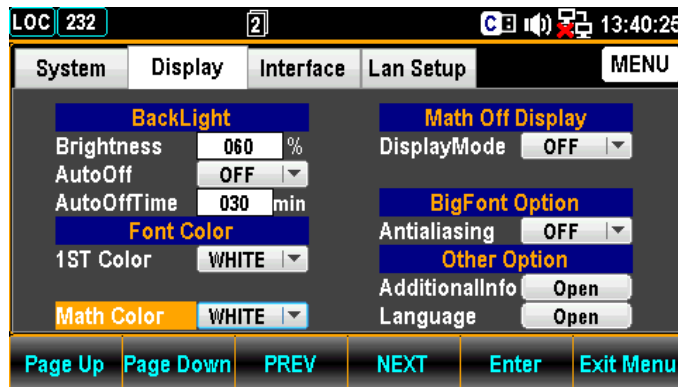

3. Press the F5 (Enter) key or Knob key followed by scrolling Knob key or pressing +/- keys to select desired color for Math display.

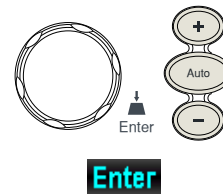

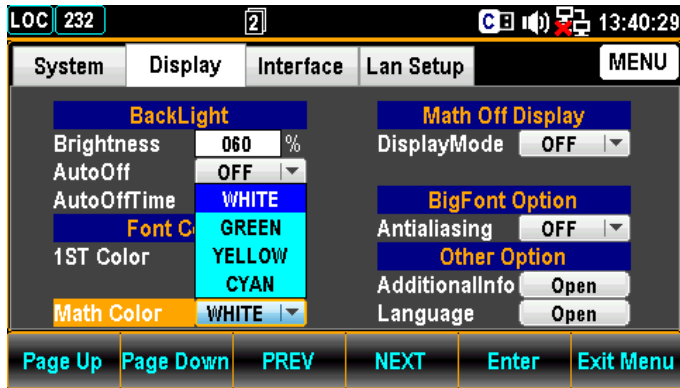

4. Press the F5 (Enter) key or Knob key to confirm the selected color.

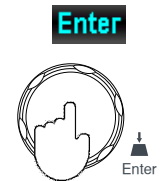

Display result

The following figure demonstrates the defined cyan color for Math display.

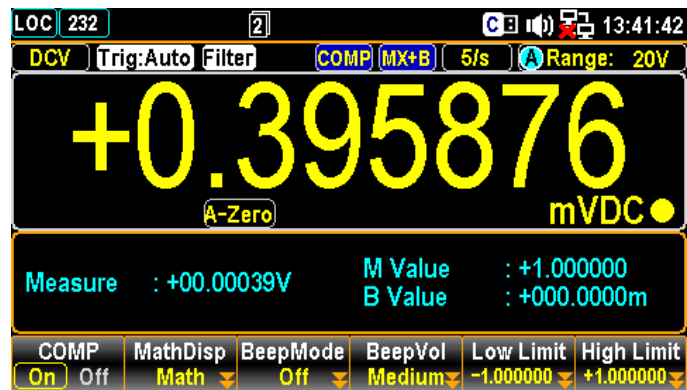

## Display Mode Setting

**Background** Enable or disable if time info or user-defined text is shown in the 1ST display only when MathDisp is off.

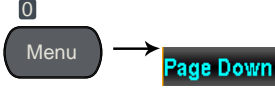
- Step**
1. Press the Menu key followed by pressing the Page Down key repeatedly until the Display configuration menu appears. 

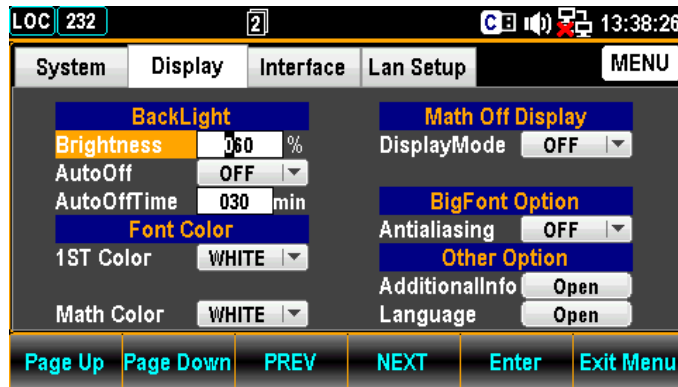

2. Press the NEXT key repeatedly or scroll the Knob key to move to the Math Off Display – DisplayMode field. 

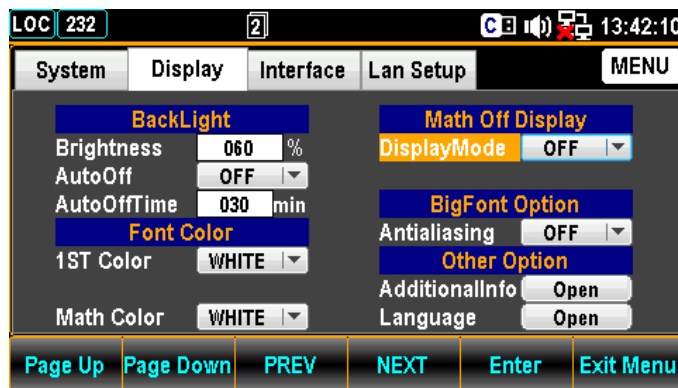

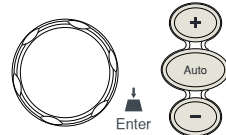
- Time display**
1. Press the F5 (Enter) key or Knob key followed by scrolling Knob key or pressing +/- keys to select the Time option. 
- Enter**



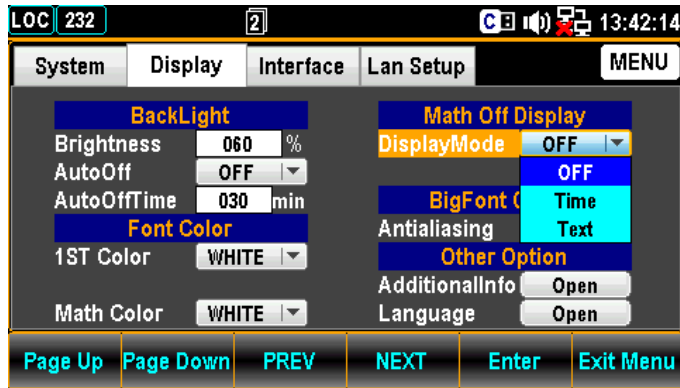

2. Press the F5 (Enter) key or Knob key to confirm the Time option.

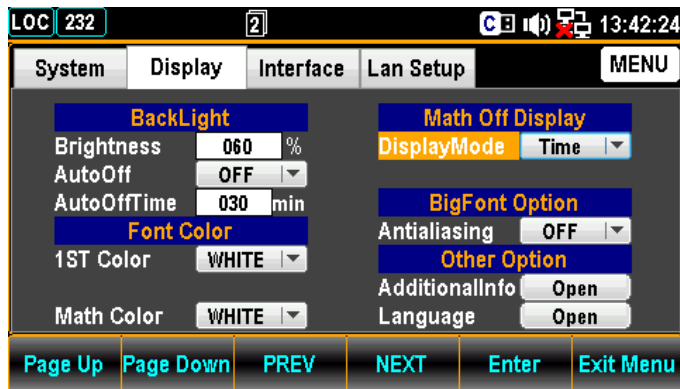
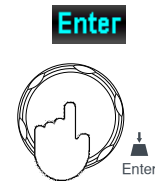

Display result

The following figure demonstrates the time info shown in the 1ST display.

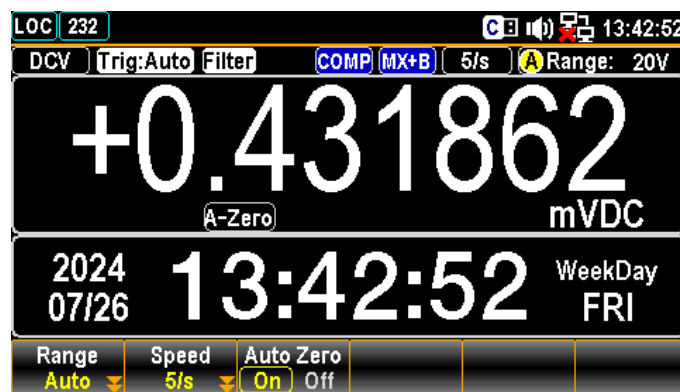

Text display

1. Press the F5 (Enter) key or Knob key followed by scrolling Knob key or pressing +/- keys to select the Text option.

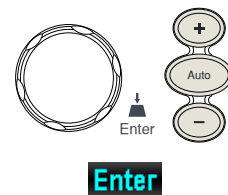

Enter

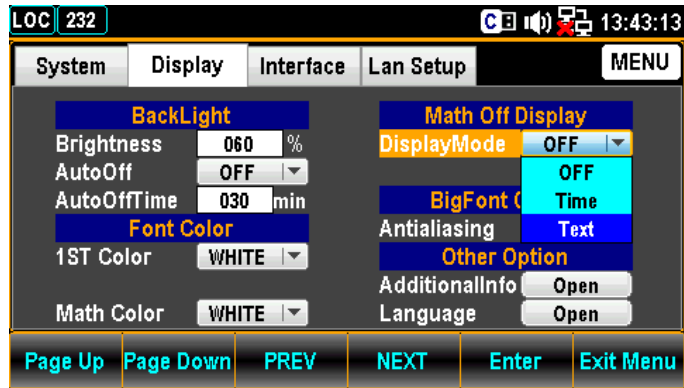

2. Press the F5 (Enter) key or Knob key to confirm the Text option.

Enter

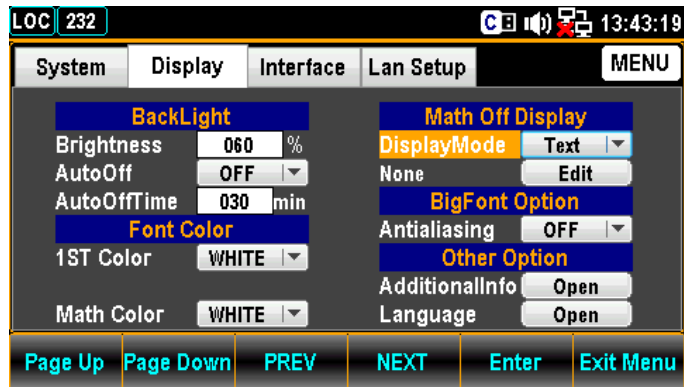

3. Press the NEXT key or scroll the Knob key to move to the Math Off Display – Edit field.

NEXT

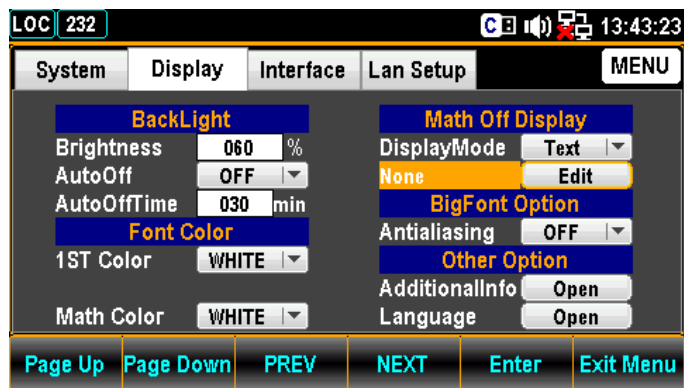

4. Press the F5 (Enter) key or Knob key to enter the KeyBoard page.

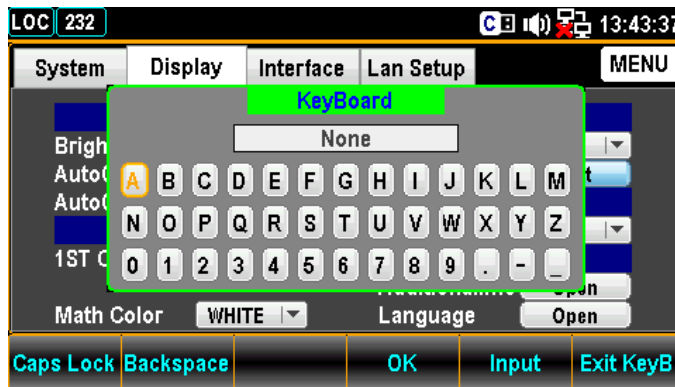
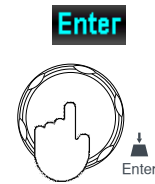

5. Press Backspace to clear default text first. Use the Left/Right & +/- keys or scroll the Knob key to move the cursor followed by pressing the F5 (Input) key or Knob key to input desired words.

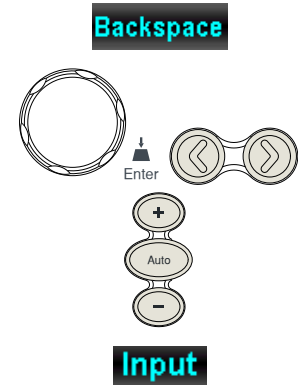

Note: F1 (Caps Lock) key is for high and low case shift.

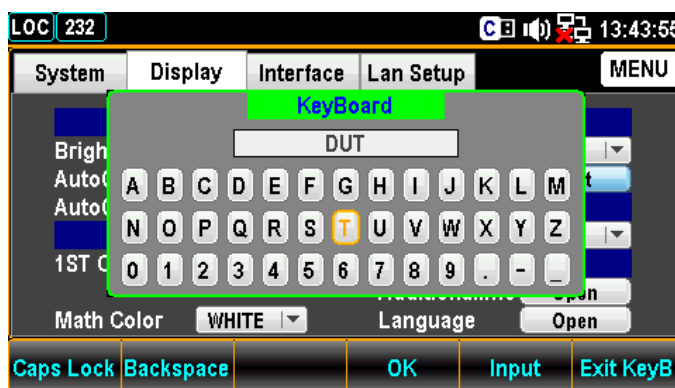

6. Press the F4 (OK) key to confirm the input words.



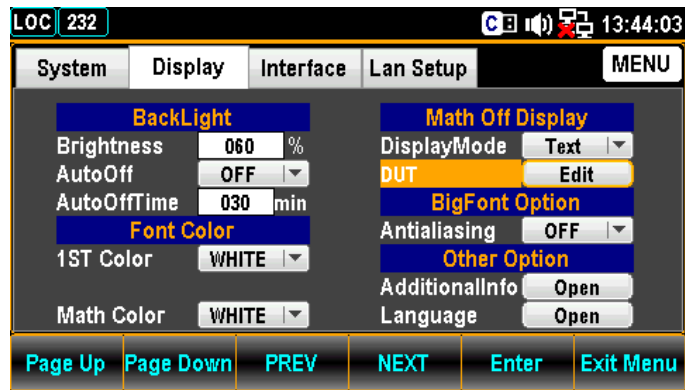

Display result

The following figure demonstrates the defined text shown in the 1ST display.

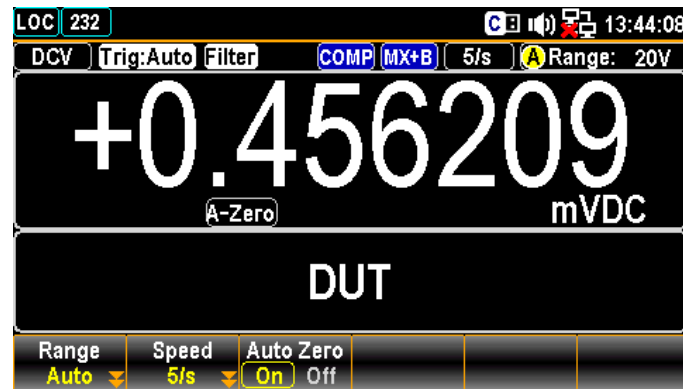

## Anti Aliasing Setting

**Background** Enable or disable the anti-aliasing function, which facilitates the display of measured value much smoother and easy-readable. Note that this function is available for up to 1.2 k / s refresh rate. The 2.4 k / s above refresh rates are Not supported by anti-aliasing.

**⚠NOTE:** When Auto Zero or dual measure mode, both of which lower down computing speed, is activated, anti-aliasing function can support up to the maximum 10 k / s refresh rate.

**Step** 1. Press the Menu key followed by pressing the Page Down key repeatedly until the Display configuration menu appears.

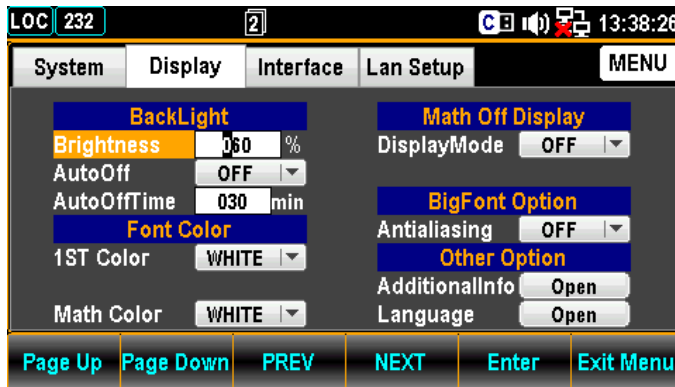

2. Press the NEXT key repeatedly or scroll the Knob key to move to the BigFont Option – Antialiasing field.

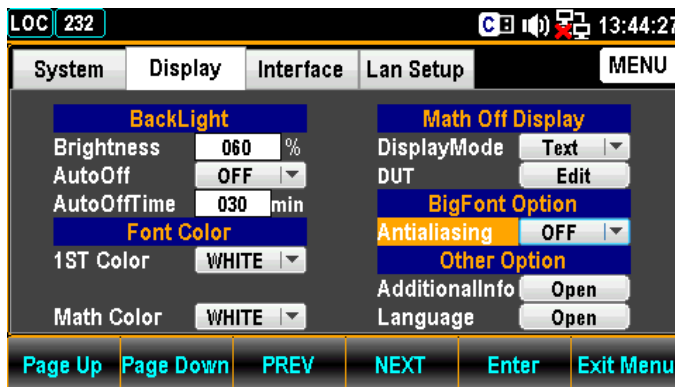

- Press the F5 (Enter) key or Knob key followed by scrolling Knob key or pressing +/- keys to select the ON option.

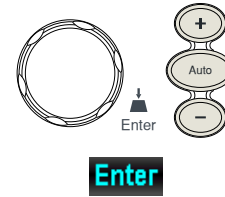

Enter

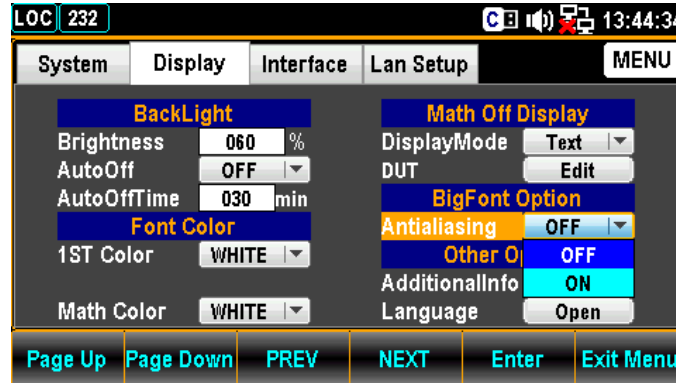

- Press the F5 (Enter) key or Knob key to confirm the ON selection.

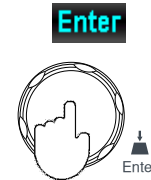

Enter

## Additional Info Setting

**Background** Enable or disable the additional information display.

- Press the Menu key followed by pressing the Page Down key repeatedly until the Display configuration menu appears.

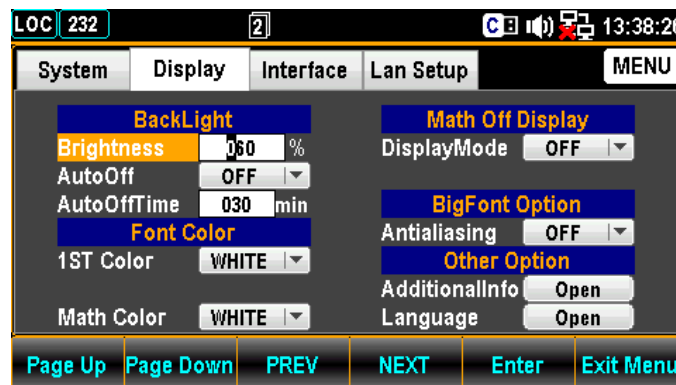
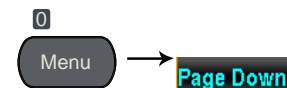

- Press the NEXT key repeatedly or scroll the Knob key to move to the Other Option – AdditionalInfo field.

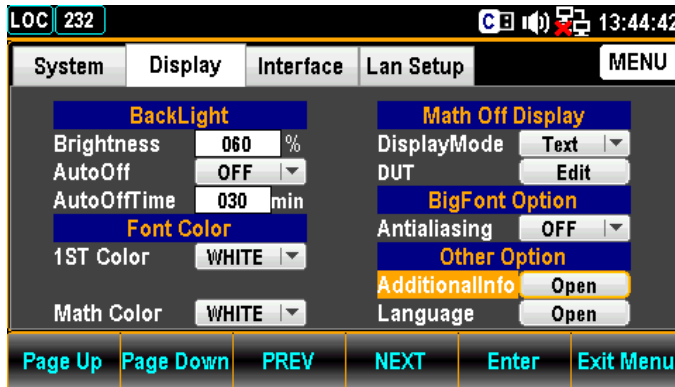

- Press the F5 (Enter) key or Knob key to enter the Additional menu. Press the Next key or scroll the Knob key followed by pushing the F5 (Enter) key or Knob key to enable/disable each option. Move to the Return option followed by pressing the F5 (Enter) key or Knob key to have the setting take effect.

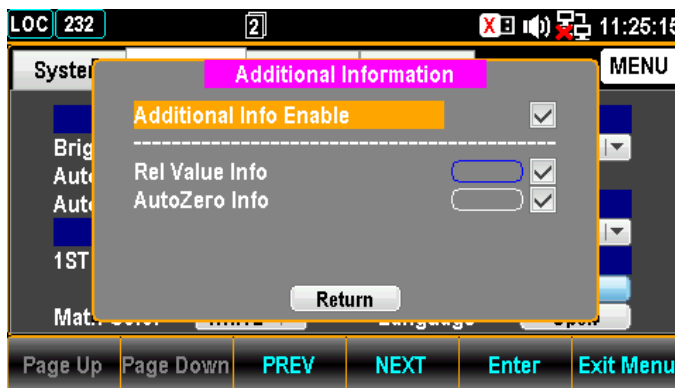
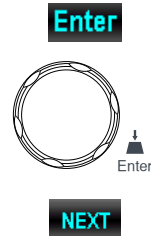

Display result

Take the following figure below for example, we can clearly recognize the colors with info as follows.

- Rel Value Info is outlined by blue frame.
- Auto Zero Info is outlined by white frame.

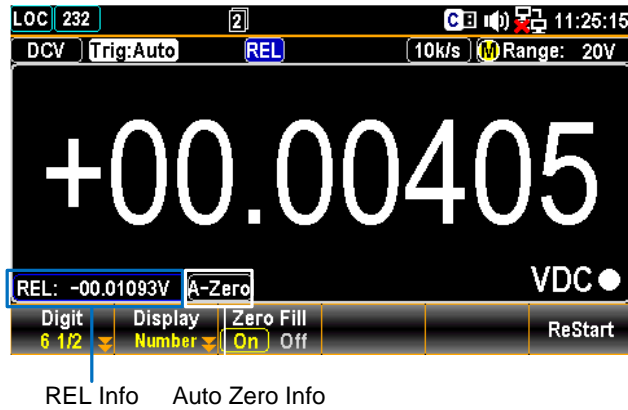

## Language Setting

**Background** Select language for user interface display.

**Step**

1. Press the Menu key followed by pressing the Page Down key repeatedly until the Display configuration menu appears.

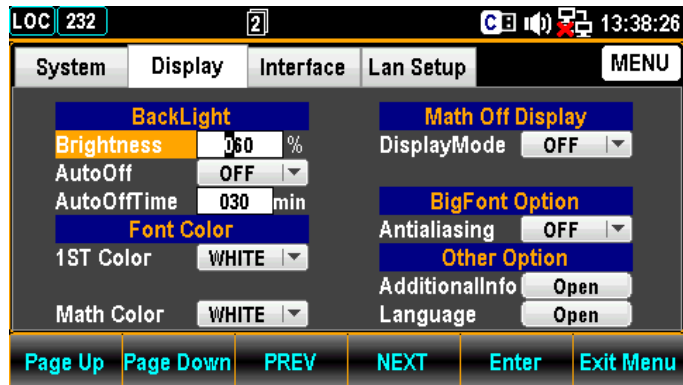
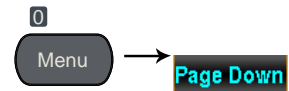

2. Press the NEXT key repeatedly or scroll the Knob key to move to the Other Option – Language field.





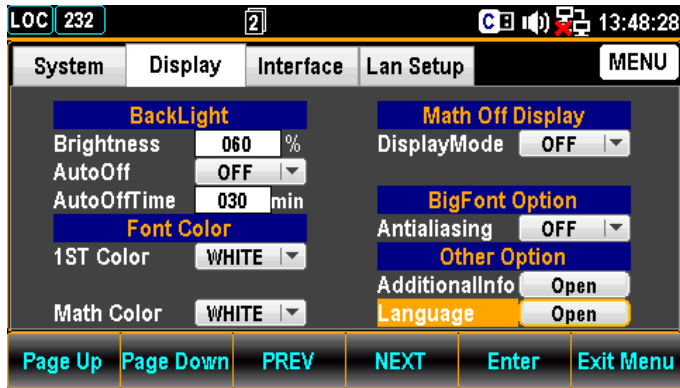

- Press the F5 (Enter) key or Knob key to enter the Language menu. Press the Next key or scroll the Knob key followed by pushing the F5 (Enter) key or Knob key to select one of the language options. Move to the Return option followed by pressing the F5 (Enter) key or Knob key to have the setting take effect.

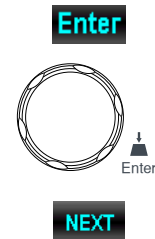

English

繁體中文 (Traditional Chinese)

Options 简体中文 (Simplified Chinese)

日本語 (Japanese)

한국어 (Korean)





NOTE

When “日本語” is checked, only prompt message will be shown in Japanese. The user interface still remains in full English display. See the figure below.



# **S**CREENSHOT & LOG

---

Capture .....	116
Save Reading .....	119

# Capture

**Background** Configure the mode of screenshot capturing.

Supported USB Sticks:

USB Disk Type: Flash Disk Only

FAT Format: Fat 16 or Fat 32 (Recommended)

Max memory size: 128 GB

 **Note** Flash disks which need to use card adaptors are not recommended to be used in this application.

**Step**

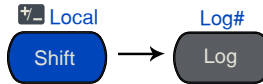
1. Press the Shift key followed by the LOG/LOG# key and the following menu appears.
 



2. Press the F1 (Log Mode) key followed by clicking the F1 (Capture) key to enable the Capture mode for screenshot.
 



3. Press the F2 (FileName) key to enter the Log FileName Mode menu. Further press the F1 (Default) key to let system saves screenshot by auto name in serial number or press the F2 (Manual) key to determine file name by user.
 



**Number Range** The auto name in serial number ranges from SCREEN00 to SCREEN99.

**Number Zero** Replugging the USB disk will zero the serial number to the initial.

 **Note** When the serial number reaches the maximum, e.g., SCREEN99, the save action will be Not available.

4. Press the F3 (EditName) key to enter the KeyBoard page where user can press the F2 (Backspace) key to clear default text. Use the Left/Right & +/- keys or scroll the Knob key to move the cursor followed by pressing the F5 (Input) key or Knob key to input desired words. The F1 (Caps Lock) key is for high and low case shift.

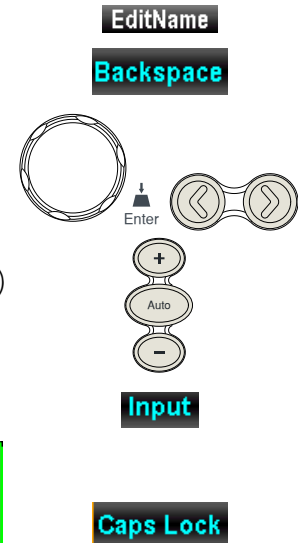

5. Press the F4 (OK) key to confirm the input words.

**OK**

 **Note** It is only available when “Manual” is selected for Log FileName Mode.

6. Press the F4 (OverWrite) key to enter the Log OverWrite Mode menu where user can press the F1 (Always) key to automatically overwrite filename when saving or press the F2 (Query) key to let system query first before saving.

**OverWrite**

**Always**

**Query**





Note

**For File Name - Default**

- Under Overwrite – “Always mode”, when replugging the USB disk, the serial number will be zeroed to the initial and the existed file in the USB disk will be overwritten automatically when saving.
- Under Overwrite – “Query mode”, when replugging the USB disk, the serial number will be zeroed to the initial and a prompt message asks, when saving, if to overwrite the existed file, click F1 (Yes) to overwrite, whilst click F2 (No) to save in a non-occupied serial number of file name. Click ESC key to simply discard the overwrite action.

**For File Name - Manual**

- Under Overwrite – “Always mode”, when replugging the USB disk, the file to save will overwrite the existed file in the USB disk by the user-editted name.
  - Under Overwrite – “Query mode”, when replugging the USB disk, a prompt message asks if to overwrite the existed file, click F1 (Yes) to overwrite, whilst click F2 (No) to bring out the KeyBoard page to reedit a file name to save. Click ESC key to simply discard the overwrite action.
-

# Save Reading

**Background** Configure the mode of data log saving.

**Step**

1. Press the Shift key followed by the LOG/LOG# key and the following menu appears.

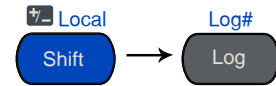

2. Press the F1 (Log Mode) key followed by clicking the F2 (SaveRead) key to enable the Save and Read mode for data log.



3. Press the F2 (FileName) key to enter the Log FileName Mode menu. Further press the F1 (Default) key to let system saves screenshot by auto name in serial number or press the F2 (Manual) key to determine file name by user.



**Number** **For Count Source**

- Range**
- The auto name in serial number ranges from DATAC000 to DATAC999.

**For Recent Source**

- The auto name in serial number ranges from DATAR000 to DATAR999.

**Number Zero** Replugging the USB disk will zero the serial number to the initial.

**Note**  When the serial number reaches the maximum, e.g., DATAC999, the save action will be Not available.

4. Press the F3 (EditName) key to enter the KeyBoard page where user can press the F2 (Backspace) key to clear default text. Use the Left/Right & +/- keys or scroll the Knob key to move the cursor followed by pressing the F5 (Input) key or Knob key to input desired words. The F1 (Caps Lock) key is for high and low case shift.

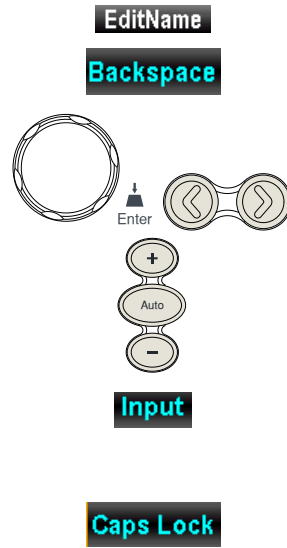

5. Press the F4 (OK) key to confirm the input words.



Note: it is only available when Manual is selected for Log FileName Mode.

6. Press the F4 (OverWrite) key to enter the Log OverWrite Mode menu where user can press the F1 (Always) key to automatically overwrite filename when saving or press the F2 (Query) key to let system query first before saving.







Note

**For File Name - Default**

- Under Overwrite – “Always mode”, when replugging the USB disk, the serial number will be zeroed to the initial and the existed file in the USB disk will be overwritten automatically when saving.
- Under Overwrite – “Query mode”, when replugging the USB disk, the serial number will be zeroed to the initial and a prompt message asks, when saving, if to overwrite the existed file, click F1 (Yes) to overwrite, whilst click F2 (No) to save in a non-occupied serial number of file name. Click ESC key to simply discard the overwrite action.

**For File Name - Manual**

- Under Overwrite – “Always mode”, when replugging the USB disk, the file to save will overwrite the existed file in the USB disk by the user-editted name.
  - Under Overwrite – “Query mode”, when replugging the USB disk, a prompt message asks if to overwrite the existed file, click F1 (Yes) to overwrite, whilst click F2 (No) to bring out the KeyBoard page to reedit a file name to save. Click ESC key to simply discard the overwrite action.
-

7. Press the F5 (Source) key to enter the SaveRead Source(Log) menu where user can select either source to save and read. Determine the source mode by further pressing the F1 (Count) key or the F2 (Recent) key. “Count” indicates the saved data log contains the total counts of measurement, whilst “Recent” represents each count of measurement has user-defined interval in the saved data log. For details, refer to page 134.

**Source**

**Count**

**Recent**



# D DISPLAY SETTING

---

<b>Digit</b> .....	<b>124</b>
<b>Display</b> .....	<b>126</b>
Number .....	126
Bar Meter .....	127
Trend Chart.....	132
Histogram .....	141
<b>Zero Fill</b> .....	<b>146</b>

# Digit

**Background** Define the maximum digit numbers for each measurement.

**Step**

1. Press Display key followed by clicking the F1 (Digit) key, the Digit menu appears where several digit options are available to select.



2. Further press F2 (6 1/2), F3 (5 1/2), F4 (4 1/2) keys for desired maximum digit numbers on display, or press the F1 (Auto) key to allow system determine digit numbers for display per measuring situation.



**Digit Parameter**    **Display**

6 1/2

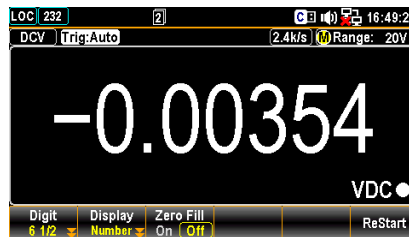

5 1/2

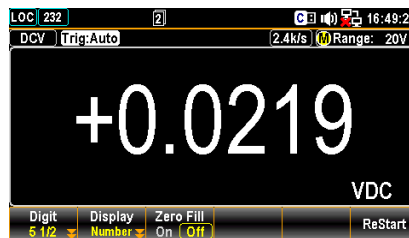

4 1/2

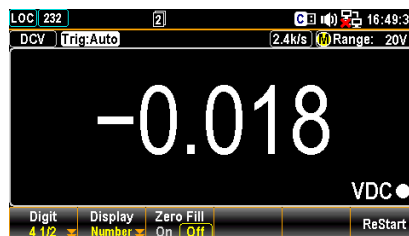

Auto

The maximum digit numbers may vary in accord with the applied measuring functions and refresh rates.

The correlation between measure types and speeds for available digit numbers

Measure Type \ Speed	Speed												
	1/s	2/s	5/s	20/s	60/s	100/s	400/s	1.2k/s	2.4k/s	4.8k/s	7.2k/s	10k/s	
DCV	-	-	6 1/2	6 1/2	6 1/2	6 1/2	5 1/2	5 1/2	5 1/2	4 1/2	4 1/2	4 1/2	

The correlation between frequency/period and gate time for available digit numbers

Measure Type \ Gate Time	Gate Time		
	1/s	100 ms	10 ms
Frequency/Period	6 1/2	5 1/2	4 1/2

# Display

## Number

**Background** Shift to the Number display mode for each measurement.

**Step** 1. Press the Display key followed by clicking the F2 (Display) key, the Display menu appears where several display options are available for selection.

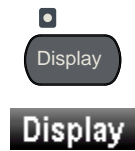

2. Press the F1 (Number) key, the screen shows the Number mode for measurement display. The measured value is presented in the clear number way for viewing, along with the maximum digits display depending on the Digit selection.



Or press the Number key on front panel to access to the Number display mode directly.



**Display**

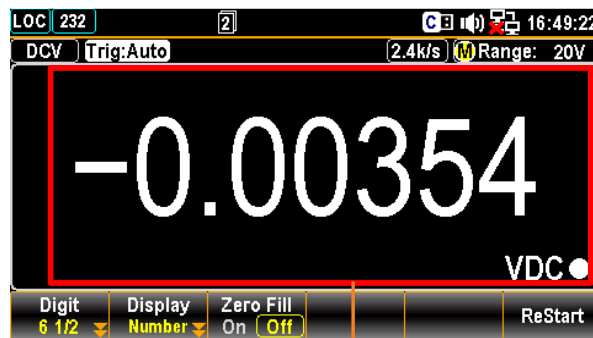

Measured value displayed in Number

## Bar Meter

**Background** Shift to the Bar Meter display for each measurement.

- Step**
1. Press the DISP key followed by clicking the F2 (Display) key, the Display menu appears where several display options are available for selection.



2. Press the F2 (Bar Meter) key, the screen shows the Bar Meter mode for measurement display. The measured value is presented in the bar meter way for viewing, along with the maximum digits display depending on the Digit selection.



**Display**

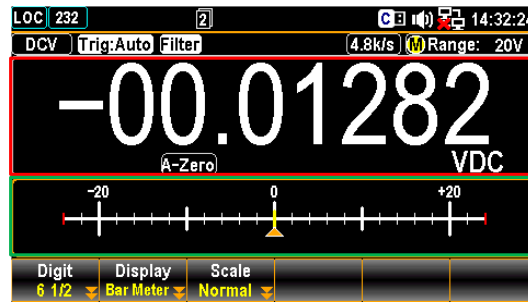

**Red Sect.** It indicates the currently measured value in number display.

**Green Sect.** It indicates the currently measured value in bar meter display.

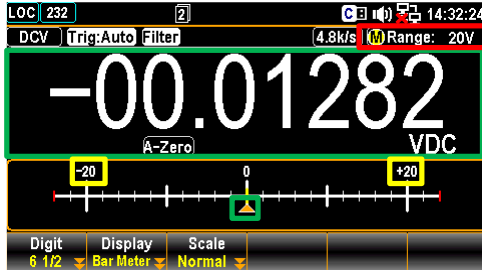
F3 (Scale) key to decide scale mode	Background	Press the F3 (Scale) key to enter the Scale Mode menu where Normal and Manual options are available for selection.
	Normal	Selecting “Normal” allows the scale of meter bar to be symmetric with the selected range of measurement.
		
		Red Sect. The user-specified range for measurement.
		Yellow Sect. The endpoints of 2 sides are “-20” and “+20” respectively, which perfectly correspond to the specified range of measurement.
		Green Sect. The currently measured value in both Number and Bar display modes, respectively.
	Manual	Selecting “Manual” allows user to customize the available scale for meter bar on display.



F4 (Method) key to decide Method mode      Backgro und      When user selects “Manual” option under the F3 (Scale) key, the Method can be further defined here for varied applications.

LowHigh      When LowHigh is selected, it is available to further determine the exact scales for both the high and low ends on the bar meter display.

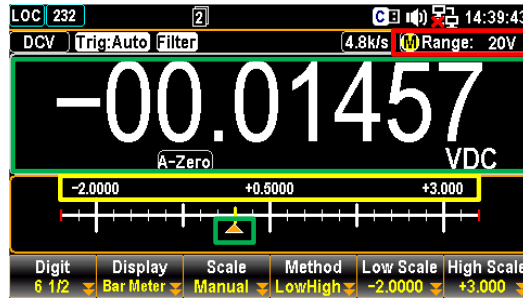

Yellow Sect.      The available scale of bar meter starts from the lowest (-2.0000) to the highest (+3.000), which are defined by user individually.

Red Sect.      The user-specified range for measurement.

Green Sect.      The currently measured value in both Number and Bar display modes, respectively.

Center      When Center is selected, it is available to further determine the exact Center value and the Span Scale for the meter bar display.

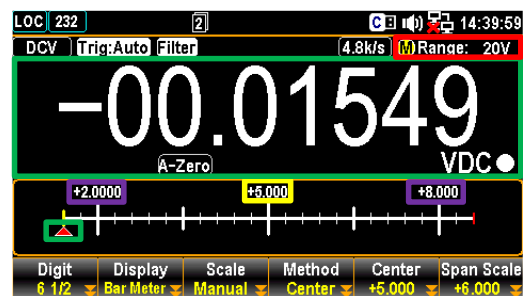

Yellow Sect.      The Center value defined by user.

Purple Sect.      The Span Scale defined by user.

Red Sect.      The user-specified range for measurement.

Green Sect.      The currently measured value in both Number and Bar display modes, respectively.

F5 (Low Scale) & F6 (High Scale) keys      After user selects “LowHigh” option under the F4 (Method) key, the low and high scales can be specified individually via F5 (Low Scale) & F6 (High Scale) keys.

Display

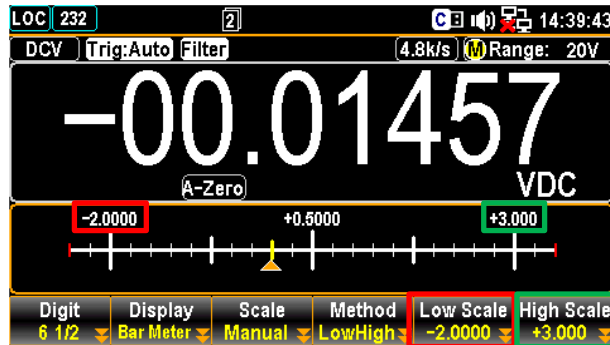

Red Sect.      The specified Low Scale (-2.0000) in F5 key is identical with the upper value in red frame on the low scale of meter bar.

Green Sect.      The specified High Scale (+3.0000) in F6 key is identical with the upper value in green frame on high scale of meter bar.

F5 (Center) & F6 (Span Scale) keys  
 When Center method is opted, user can further determine the Center and Span Scale individually via F5 (Center) & F6 (Span Scale) keys.

Display

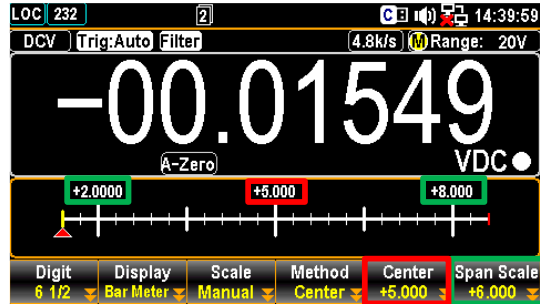

Red Sect. The specified Center (+5.000) in F5 key is identical with the upper value in red frame on the center value of meter bar.

Green Sect. The specified Span Scale (+6.000) in F6 key indicates the whole scale of the meter bar, which means +6.000 will be evenly divided into 2 ends of the meter bar that results in +2.000 in the left end and +8.000 in the right end as the figure shown.

## Trend Chart

**Background** Shift to the Trend Chart display for each measurement.

**Step** 1. Press the DISP key followed by clicking the F2 (Display) key, the Display menu appears where several display options are available for selection.



2. Press the F3 (TrendChart) key, the screen shows the Trend Chart mode for measurement display. The measured value is presented in the trend chart way for viewing, along with the maximum digits display depending on the Digit selection.



Or press the Trend Chart key on front panel to access to the Trend Chart display mode directly.



**Display**

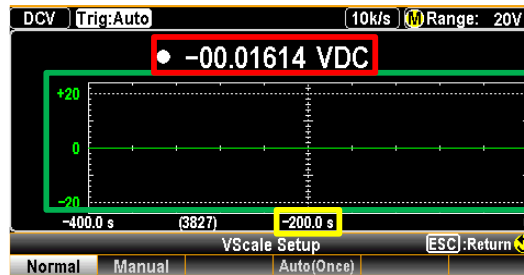

**Red Sect.** It indicates the currently measured value in number display.

**Green Sect.** It indicates the latest measurements of 400 counts in the intuitive trend chart.

**Yellow Sect.** The total counts of measurement with the maximum of 100,000. Only 400 counts, however, can be displayed in the trend chart at once.

**F3 (VScale) key to define** **Background** Press the F3 (Scale) key to enter the VScale Setup menu where Normal and Manual options are available for selection.

vertical scale      Normal      Selecting “Normal” allows the vertical scale of trend chart to be symmetric with the selected range of measurement.

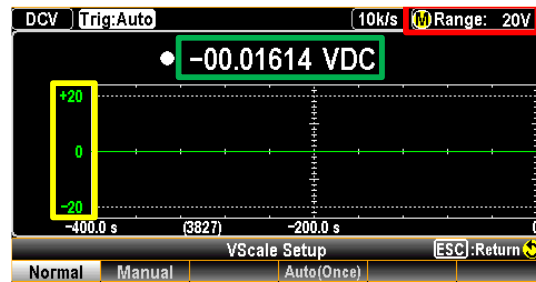

Red Sect.              The user-specified range for measurement.

Yellow Sect.          The highest scale (+20) corresponds to the upper defined manual range 20 V, and the lowest scale is the relative value in the opposite spectrum.

Green Sect.           The currently measured value.

Manual                Selecting “Manual” allows user to customize the available scale for trend chart on display.

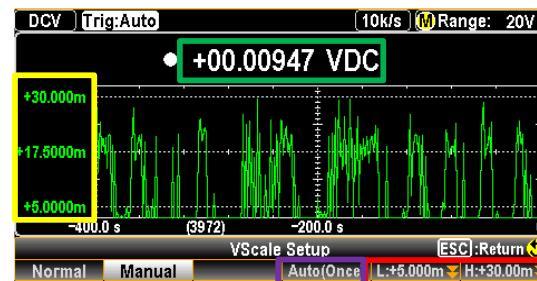

Red Sect.              The user-specified highest and lowest scales. Press the F5 and F6 keys to set up individually.

Yellow Sect.          Both the highest scale (+30.000m) and the lowest scale (+5.0000m) correspond to the user-specified values in the red section.

Green Sect.           The currently measured value.

Purple Sect.          Press the F4 (Auto(Once)) key to obtain the highest and lowest scales from the latest 400 counts of measurements into the trend

chart as a baseline of vertical scale. Take the figure below for instance, the highest and lowest ends in vertical scale are irregular values +29.555 m and -24.700 m which come from the latest measurements.

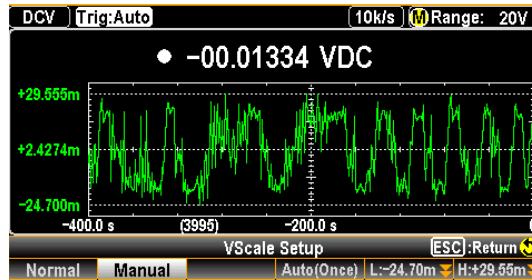

F4 (HScale) key to define horizontal scale

Background  
und  
Count

Press the F4 (HScale) key to enter the HScale Setup menu where Count and Recent options are available for selection.

Selecting “Count” allows the horizontal scale of trend chart to be symmetric with the defined refresh rate of measurement.

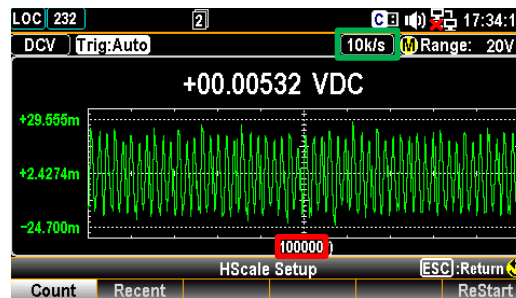

Green Sect. The user-defined refresh rate.

Red Sect. The refreshing frequency of the total counts of measurements is consistent with the refresh rate. For example, setting 10 k/s results in the fastest frequency, while 1s leading to the slowest frequency.

Recent

Selecting “Recent” allows the horizontal scale of trend chart to be customized by user.

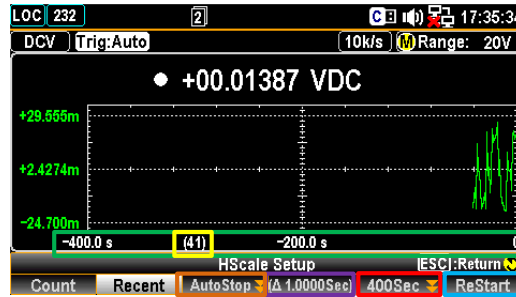

Red Sect. The user-specified range of horizontal scale in the unit of second. Press the F5 key to set up individually.

Green Sect. The horizontal scale ranging from the right-side 0 to the left-hand -400.0 s that corresponds to the user-specified range of horizontal scale.

Yellow Sect. The currently total counts of measurement.

Orange Sect. The user-specified auto-stop feature of the F3 key, which automatically suspends recording after a course of time period defined by user from the field highlighted in red as follows.

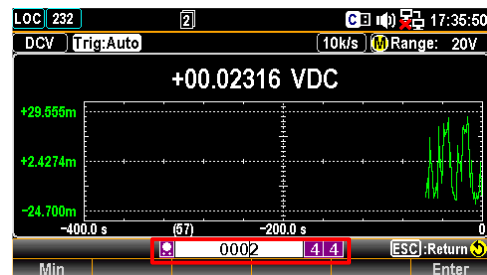

Value: 1~9999 Min

After confirming the time period for auto-stop, click “Start” in orange and the countdown appears on top of screen as the field highlighted in yellow below.

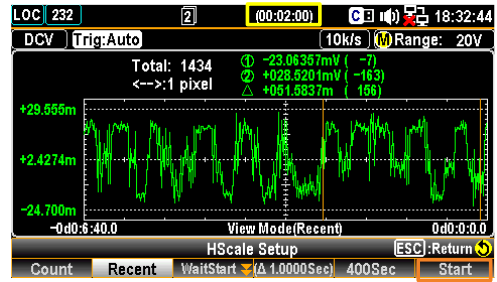

Purple Sect. The interval of each count of measurement which relates to the user-specified range of horizontal scale. To put it simply, due to the maximum 400 counts at once, when setting 400 Sec, the interval is equal to 400 Sec divided by 400 counts = 1 second. If setting 800 Sec, it turns out  $800/400 = 2$  seconds.

Blue Sect. Press the F6 (Restart) key to recount the measurements.

F5  
(Stop&View)  
key for data

Press the F5 (Stop&View) key to enter the View Setup (Trend) mode which empowers user to have a detailed view into the measured data on the trend chart. Once clicking the key, measurement will stop right away.

Display

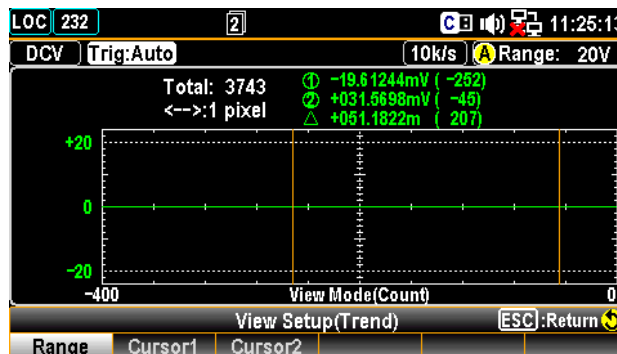

F1 key  
(Range)

Press the F1 (Range) key to check a certain course of range of the measured counts. Scroll the Knob key rightward or leftward to move cursor on different sections.



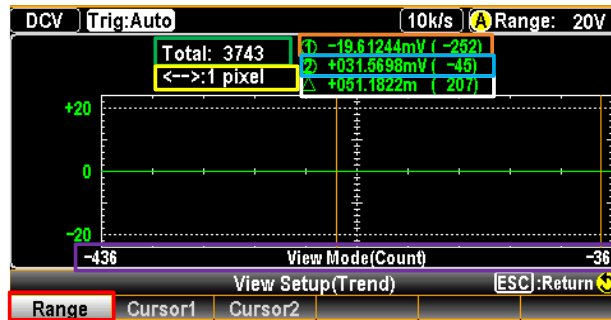

Red Sect. Press the F1 (Range) for range check.

Green Sect. The total counts of measurements before entering the Stop&View.

Yellow Sect. Press the Knob key to change the maximum counts for display.

1 pixel – 4 pixels – 400 pixels

Orange Sect. The lowest value of the selected count with its affiliated serial number.

Blue Sect. The highest value of the selected count with its affiliated serial number.

White Sect. The delta between the highest and lowest values of the selected count with its affiliated serial number.

Purple Sect. The scale of measurements displayed, which relates to the yellow section – pixels. When 40 pixels are defined previously, scroll the Knob key once, the scale will increase or decrease 40 counts per time.

F2 key (Cursor1 ) Press the F2 (Cursor1) key to check the lowest value of each count. Scroll the Knob key rightward or leftward to move cursor on different sections.

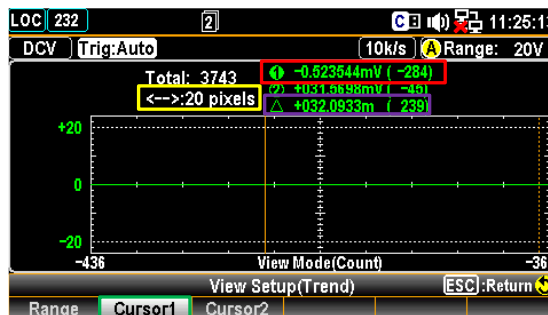

Green Sect.	Press the F2 (Cursor1) for checking the lowest value of each count.
Red Sect.	The lowest value of the selected count with its affiliated serial number.
Yellow Sect.	Press the Knob key to change the maximum counts for display.  1 pixel – 10 pixels – 20 pixels
Purple Sect.	The delta between the highest and lowest values of the selected count with its affiliated serial number.

F3 key (Cursor2) Press the F3 (Cursor2) key to check the highest value of each count. Scroll the Knob key rightward or leftward to move cursor on different sections.

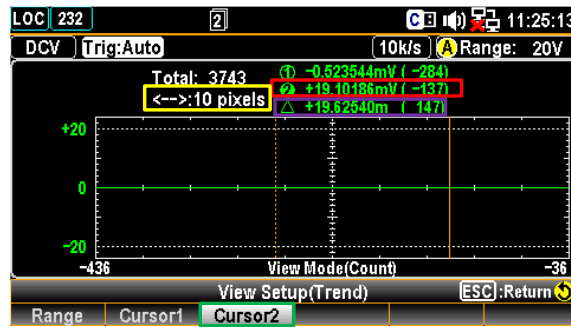

Green Sect.	Press the F3 (Cursor2) for checking the highest value of each count.
Red Sect.	The highest value of the selected count with its affiliated serial number.
Yellow Sect.	Press the Knob key to change the maximum counts for display.  1 pixel – 10 pixels – 20 pixels
Purple Sect.	The delta between the highest and lowest values of the selected count with its affiliated serial number.

F4 key  
(COU/TIM)

**COU**

Press the F4 (COU/TIM) key to toggle between the 2 modes (COU/TIM). In association with the previous F1 (Range), F2 (Cursor1) and F3 (Cursor2) keys, user can utilize COU to check diversified values of each count per needs

 Note This option is only available when “Recent” under HScale is selected.

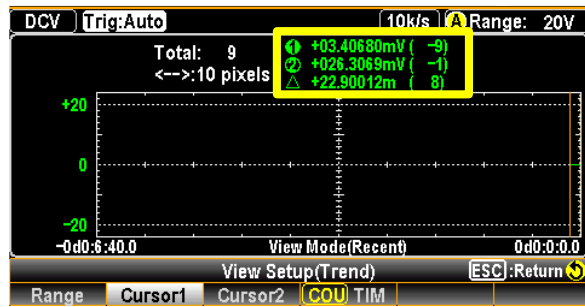

Yellow Sect. The display basically is identical with the previous introductions of F1 (Range), F2 (Cursor1) and F3 (Cursor2) keys. Refer to each section for further details.

**TIM**

Press the F4 (COU/TIM) key to toggle between the 2 modes (COU/TIM). In association with the previous F1 (Range), F2 (Cursor1) and F3 (Cursor2) keys, user can utilize TIM to check time parameters of each count per needs.

 Note This option is only available when “Recent” under HScale is selected.

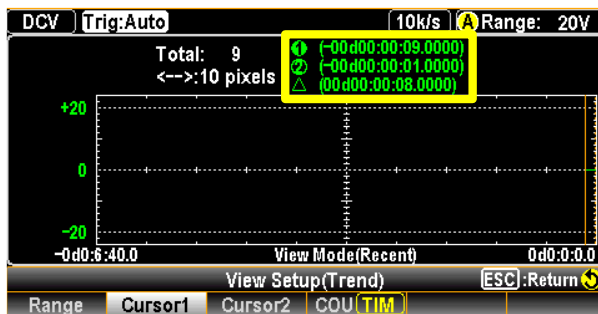

Yellow Sect. The time parameters of the selected lowest, highest and delta values display in the clear time format below, which indicate the exact day and time when the selected values occurred respectively.

+0d00:02:02.6000  

 Day Hour Minute Second

**F6 (Start) key to restart measurement** After entering the View Setup (Trend) mode, system will halt the measurement right away. Exit the View Setup (Trend) mode and press the F6 (Start) key to restart measurement.

When measurement is ongoing, press the F6 (ReStart) key to recount the accumulated measurements.

## Histogram

**Background** Shift to the Histogram display for each measurement.

- Step**
1. Press the DISP key followed by clicking the F2 (Display) key, the Display menu appears where several display options are available for selection.

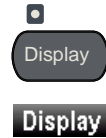

2. Press the F4 (Histogram) key, the screen shows the Histogram mode for measurement display. The measured value is presented in the way of histogram for viewing, along with the maximum digits display depending on the Digit selection.



Or press the Histogram key on front panel to access to the Histogram display mode directly.

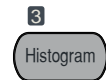

**Display**

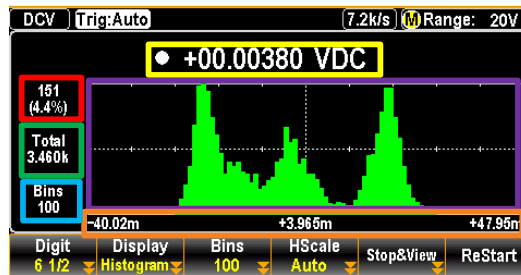

**Green Sect.** It indicates the total measured bins accumulated currently.

**Red Sect.** It indicates bins of the highest section of measured values with its affiliated percentage from the total counts of measurements.

**Yellow Sect.** The currently measured value.

**Purple Sect.** The histogram display for the measured bins. Up to the 400 latest bins can be shown concurrently.

**Blue Sect.** The maximum bin numbers displayed within the purple section.

Orange Sect. The range of horizontal scale of histogram display.

F3 (Bins) key to define bin numbers

Background

Press the F3 (Bins) key to enter the Bins Setup menu where user can customize the maximum numbers of stripe-like bins for display.

Note: The available options for bin numbers will vary in accordance with the defined refresh rate. Faster the refresh rate, smaller the numbers of bins available.

Display

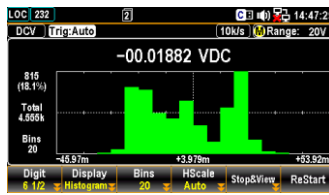

The histogram is defined with 20 bins display. The central line divides the left and right parts, each of which contains 10 bins respectively.

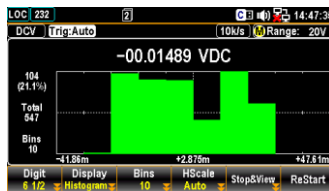

The 10 bins setting make the histogram display much thicker in its each bin compared to the previous 20 bins setting.

The max bin number varies by the refresh rate. Check the table below for correlative parameters.

Refresh Rate	5/s ~	4.8 k/s	7.2 k/s	10 k/s
	2.4 k/s			
Max. Bin Number	400	200	100	20

F4 (HScale) key to define horizontal scale

Background

Press the F4 (HScale) key to enter the HScale Setup menu where Auto and Manual options are available for selection.

Auto

Selecting “Auto” allows the frequency of the measuring counts to be symmetric with the defined refresh rate. For example, setting 10 k/s results in the fastest frequency, while 1s leading to the slowest frequency.

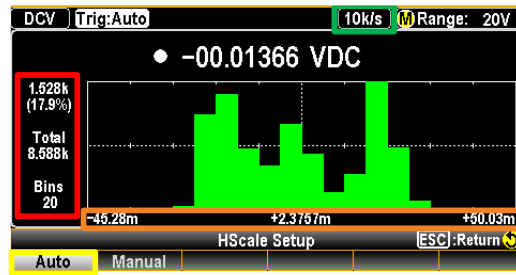

Yellow Sect. Press the F1 (Auto) key for auto HScale setup mode.

Green Sect. The user-defined refresh rate.

Red Sect. The frequency of the measured total counts, highest values percentage and bin numbers is consistent with the refresh rate.

Orange Sect. The range of horizontal scale of histogram display varies according to the currently measured value.

Manual

Selecting “Manual” allows the horizontal scale of histogram display to be customized by user.

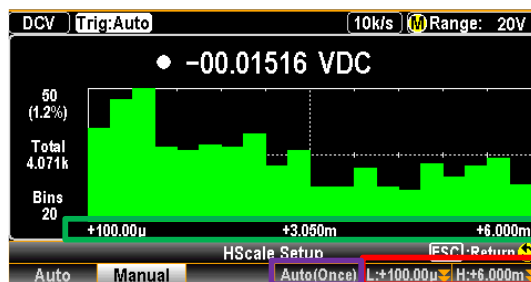

Red Sect. The user-specified highest and lowest scales. Press the F5 and F6 keys to set up individually.

Green Sect. The horizontal scale ranging from the right-side +6.000 m to the left-hand +100.00 u that corresponds to the user-specified range of horizontal scale.

Purple Sect. Press the F4 (Auto(Once)) key to obtain the highest and lowest scales from the latest bins of measurement within the histogram as a baseline for horizontal scale. Take the figure below for instance, the right and left ends in horizontal scale are irregular values +33.91 m and -27.94 m which come from the latest measurement of bins.

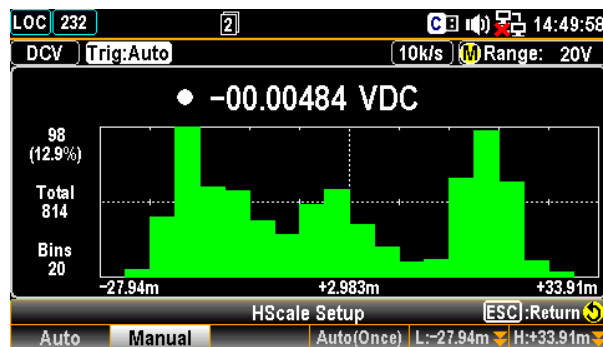

F5 (Stop&View) key for data

Press the F5 (Stop&View) key to enter the View Setup (His) mode which empowers user to have a detailed view into the measured data on the histogram. Once clicking the key, measurement will stop right away.

Display

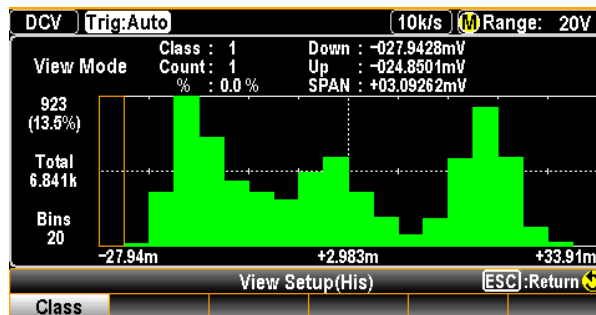

F1 key (Class)

Press the F1 (Class) key to check the detailed data of each bin from the histogram measurement.

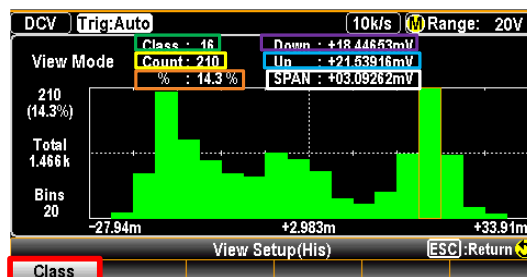

Red

It indicates the Class mode under



	Sect.	View Setup (His) is activated.
	Green Sect.	It indicates the selected bin number. Scroll the Knob key rightward or leftward to change bin number for checking.
	Yellow Sect.	It indicates the total accumulated counts of measurement categorized within the selected bin number.
	Orange Sect.	It indicates the exact percentage of the total counts of measurement from the selected bin number.
	Purple Sect.	It indicates the lowest value being measured within the selected bin number.
	Blue Sect.	It indicates the highest value being measured within the selected bin number.
	White Sect.	It indicates the difference in value between the purple section (Down) and the blue section (Up).
F6 (Start) key to restart measurement	After entering the View Setup (His) mode, system will halt the measurement right away. Exit the View Setup (His) mode and press the F6 (Start) key to restart measurement.	
	When measurement is ongoing, press the F6 (ReStart) key to recount the accumulated measurements.	

# Zero Fill

**Background** Define if full digit with additional zero “0” is displayed or not in the Number display mode only.

**Step** 1. Press the Display key followed by clicking the F3 (Zero Fill) key to turn On or Off the function. 

2. Take the Digit setting of 6 1/2 for example, when Zero Fill is turned On, the additional zero value is filled to full digit display in 7 digits, which corresponds to the 6 1/2 digit setting. 

**Zero Fill**                      **6 1/2 Digit**

**On**

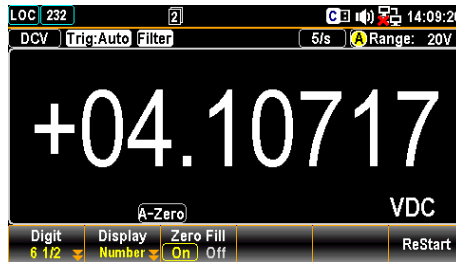

When it is turned Off, the additional zero value is eliminated to display exactly measured reading in a clear manner. 

**Zero Fill**                      **6 1/2 Digit**

**Off**

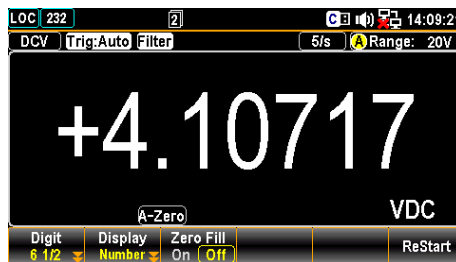

- The setting of Zero Fill is “On” by default.
- Per varied applications, choose On or Off for Zero Fill for your appropriate usage.

# RREMOTE CONTROL

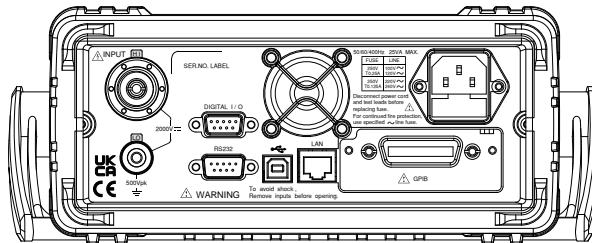

<b>Configure Interface .....</b>	<b>148</b>
Return to Local Control Mode .....	148
Configure USB Interface .....	148
Set the USB Protocol .....	150
Configure RS232 Interface .....	151
Set the FlowCtrl handshake .....	160
Set the EOL Character .....	160
Set the Separation Character .....	160
Insert GPIB Card (Optional) .....	161
Configure GPIB Interface .....	162
Activate Ethernet Interface.....	166
LAN Connect Delay Time .....	167
Reboot LAN Setup .....	168
Configure Ethernet Interface to DHCP .....	169
Configure Ethernet IP .....	170
Configure Protocol .....	175
Remote Terminal Session (Telnet / TCP) .....	182
<b>Web Control Interface .....</b>	<b>183</b>

# Configure Interface

## Return to Local Control Mode

**Background** When the unit is in remote control mode, the RMT icon  above the main display can be seen. When this icon is not displayed, it indicates that the unit is in local control mode.

In order to switch back to the Local control mode (front panel operation), press the Shift key.



## Configure USB Interface

**USB Configuration** PC side connector Front panel, Type A, host

Unit side connector Real panel, Type B, device

USB Speed 2.0 (Full speed)

- Steps**
1. Press the Menu key, and then the Page Down key repeatedly until the Interface configuration menu appears.

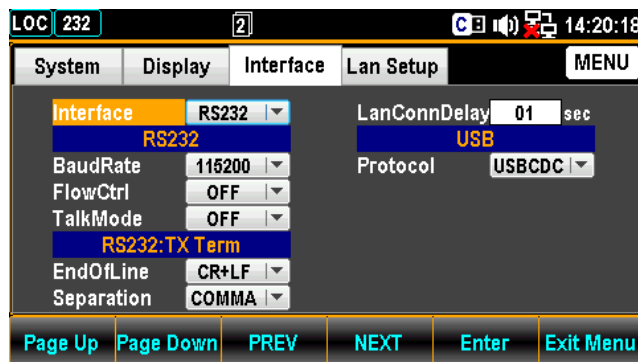
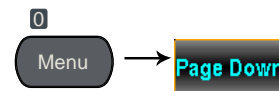

2. Press the F5 (Enter) key or Knob key followed by scrolling Knob key or pressing +/- keys to land on the USB option.

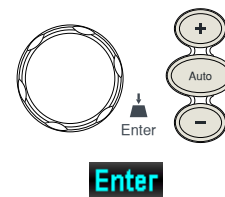

**Enter**

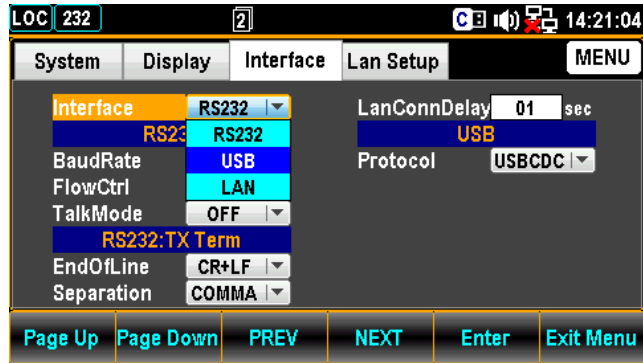

3. Press the F5 (Enter) key or Knob key to select the USB option.



4. Press the F4 (NEXT) key repeatedly or scroll the Knob key to move to the USB - Protocol field.

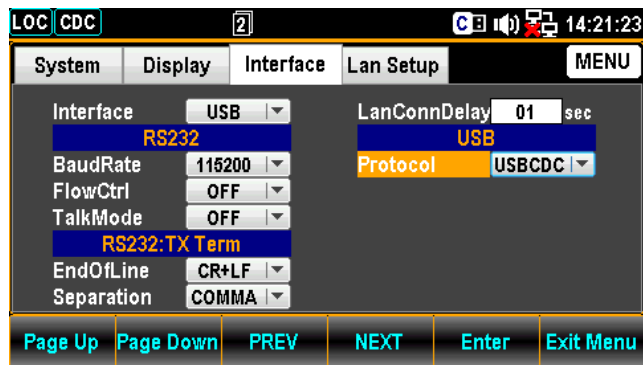

5. Press the F5 (Enter) key or Knob key followed by scrolling Knob key or pressing +/- keys to land on the desired USB Protocol option.

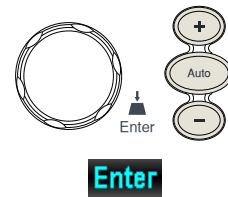

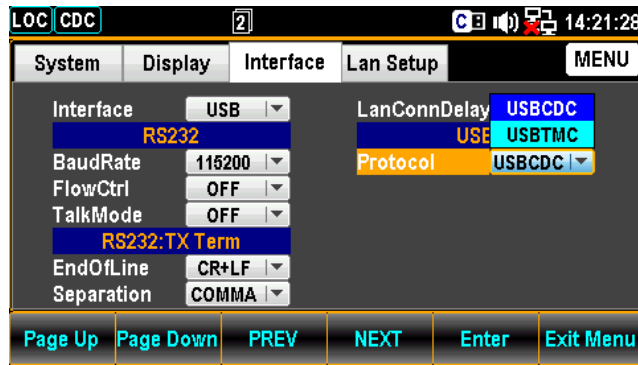

6. Press the F5 (Enter) key or Knob key again to confirm the USB Protocol option.

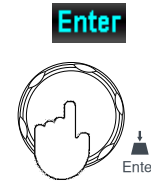

7. Connect the USB cable to the rear panel terminal (upper port).



## Set the USB Protocol

### Description

The USB device port on the rear panel is used for remote control. The USB port can be configured as either a TMC or CDC interface.

Before the GVM-9102 can be used for remote control utilizing the CDC or TMC USB class, install the appropriate CDC or TMC USB driver included on the User Manual CD.

USBCDC:

The USB port on the GVM-9102 will appear as a virtual COM port to a connected PC.

USBTMC:

The GVM-9102 can be controlled using National Instruments NI-Visa software\*. NI-Visa supports USB TMC.



\*To use the TMC interface National Instruments Measurement and Automation Explorer can be used. This program is available on the NI website, [www.ni.com](http://www.ni.com), via a search for the VISA Run-time Engine page, or “downloads” at the following URL, <http://www.ni.com/visa/>

## Configure RS232 Interface

RS232 Configuration Connector	D-sub 9 pin, male
Baud rate	115200/57600/38400/19200/9600
Data bits	8
Parity	none
Stop bits	1
Flow control	none, RTS/CTS, DTR/DSR

Step

1. Press the Menu key, and then the Page Down key repeatedly until the Interface configuration menu appears.

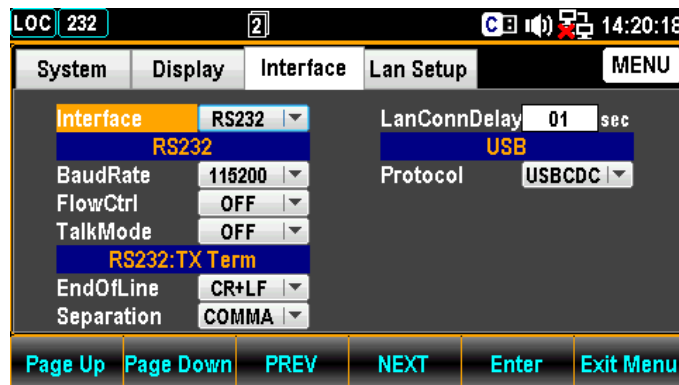
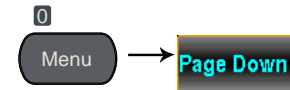

2. Press the F5 (Enter) key or Knob key followed by scrolling Knob key or pressing +/- keys to land on the RS232 option.

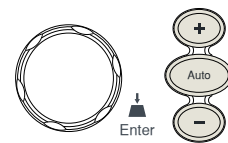

**Enter**

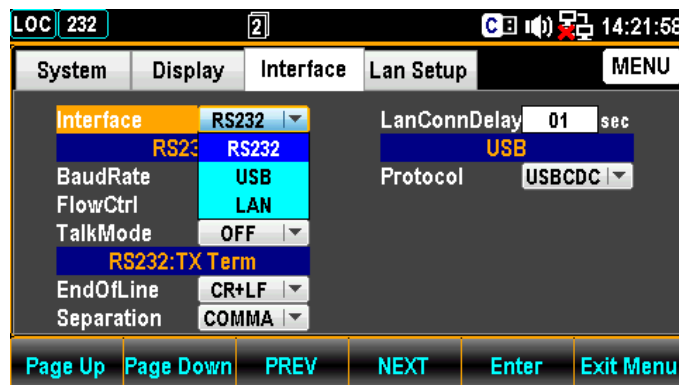

3. Press the F5 (Enter) key or Knob key to select the RS232 option.

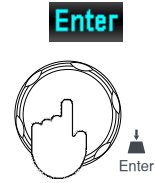

4. Press the F4 (NEXT) key repeatedly or scroll the Knob key to move to the RS232 - Baud Rate field.

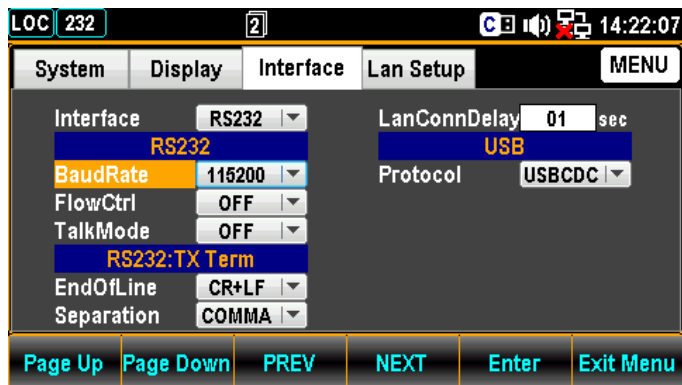
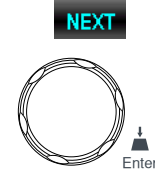

5. Press the F5 (Enter) key or Knob key followed by scrolling Knob key or pressing +/- keys to land on the desired RS232 Baud Rate option.

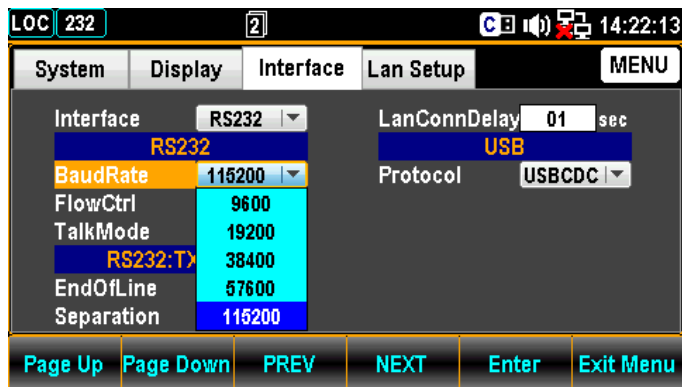
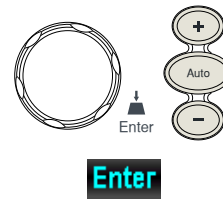



6. Press the F5 (Enter) key or Knob key again to confirm the desired RS232 Baud Rate option.

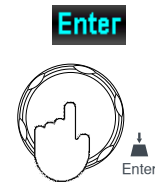

7. Press the F4 (NEXT) key repeatedly or scroll the Knob key to move to the RS232 - FlowCtrl field.

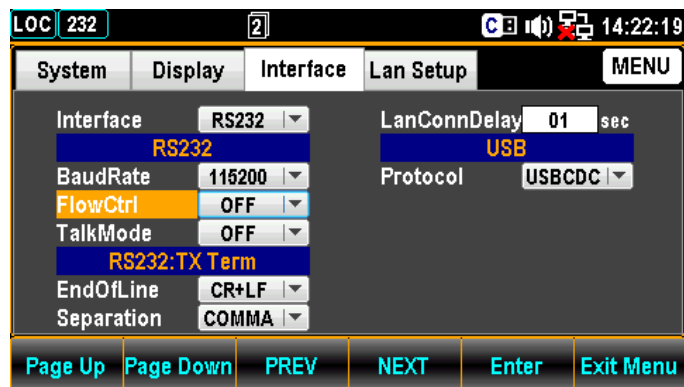

8. Press the F5 (Enter) key or Knob key followed by scrolling Knob key or pressing +/- keys to land on the desired RS232 FlowCtrl option.

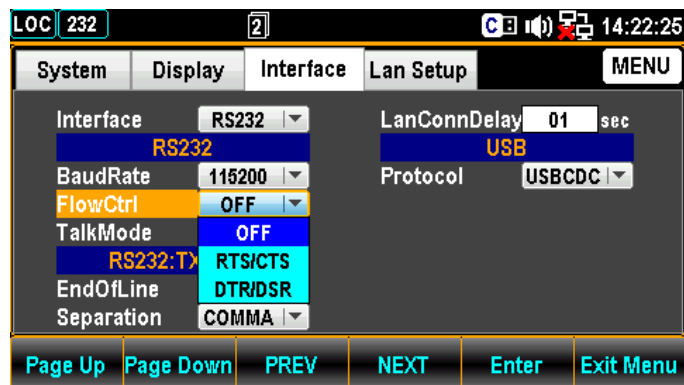
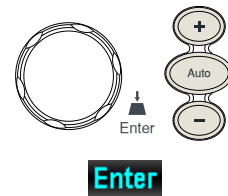

9. Press the F5 (Enter) key or Knob key again to confirm the desired RS232 FlowCtrl option.

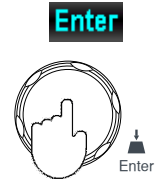

10. Press the F4 (NEXT) key repeatedly or scroll the Knob key to move to the RS232 Talk Mode field, which is specific for RS232 interface and allows measured readings to be sent to remote device continuously.

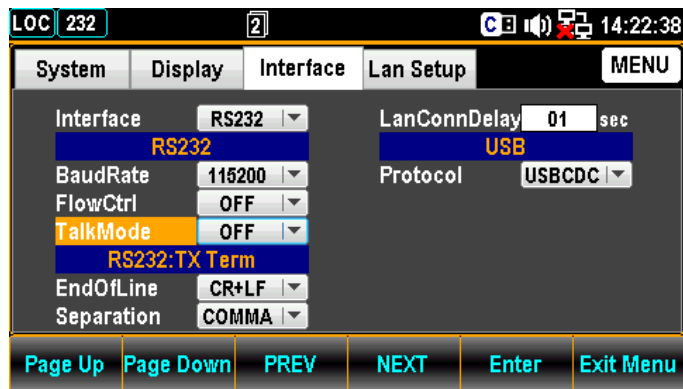
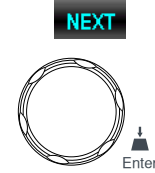

11. Press the F5 (Enter) key or Knob key followed by scrolling Knob key or pressing +/- keys to land on the desired RS232 Talk Mode option.

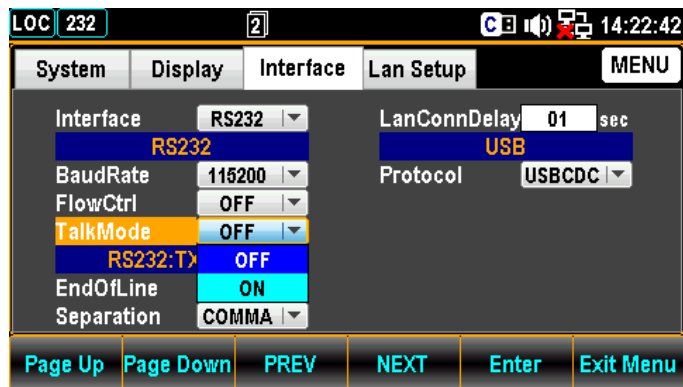
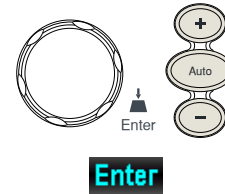

12. Press the F5 (Enter) key or Knob key again to confirm the desired RS232 Talk Mode field option.

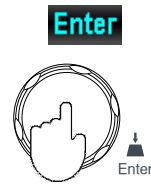

13. Press the F4 (NEXT) key repeatedly or scroll the Knob key to move to the RS232: TX Term - EndOfLine field.

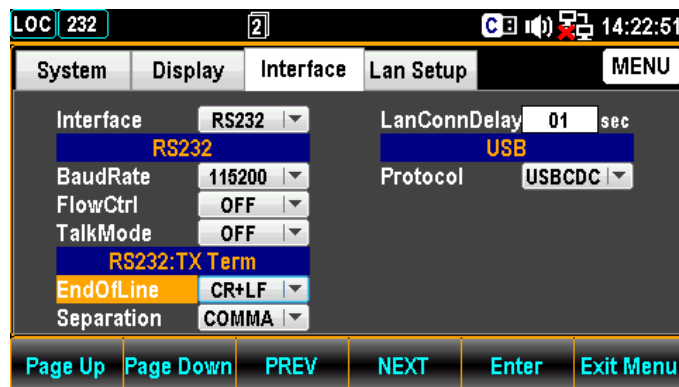

14. Press the F5 (Enter) key or Knob key followed by scrolling Knob key or pressing +/- keys to land on the desired RS232: TX Term - EndOfLine option.

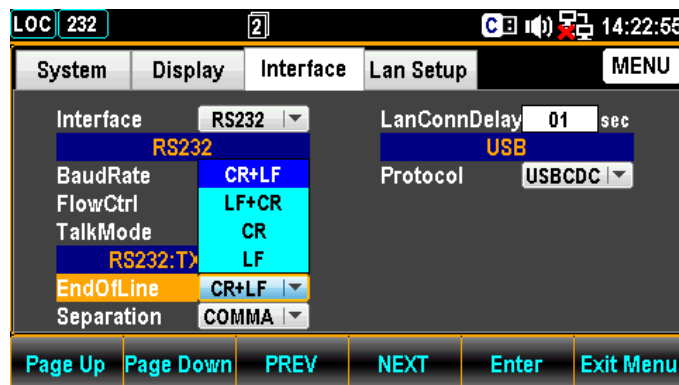
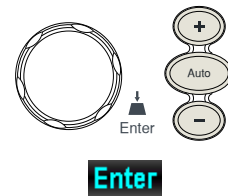

15. Press the F5 (Enter) key or Knob key again to confirm the desired RS232: TX Term EndOfLine option.



**NOTE** GPIB, USBTMC and LAN are fixed with only LF option.

16. Press the F4 (NEXT) key repeatedly or scroll the Knob key to move to the RS232: TX Term - Separation field.

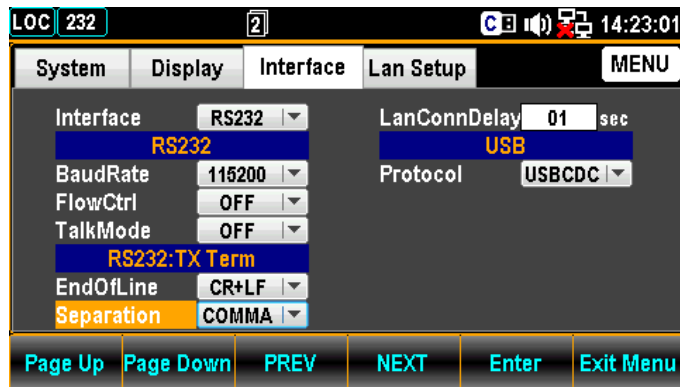

17. Press the F5 (Enter) key or Knob key followed by scrolling Knob key or pressing +/- keys to land on the desired RS232: TX Term - Separation option.

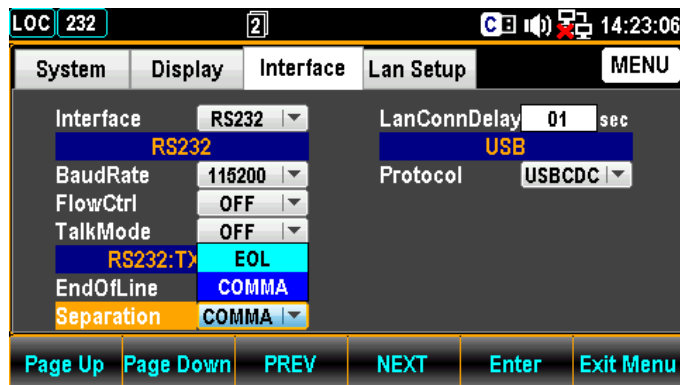
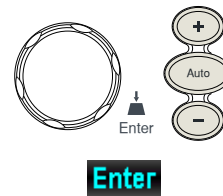

18. Press the F5 (Enter) key or Knob key again to confirm the desired RS232: TX Term Separation option.

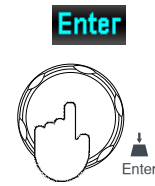

**NOTE** GPIB, USBTMC and LAN are fixed with only COMMA option.

19. Connect the RS232 cable to the rear panel terminal.

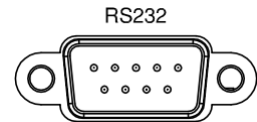

RS232 Pin Assignment

Pin	Input/Output	Description
1	-----	No Connection
2	Input	Receive Data (RxD)
3	Output	Transmit Data (TxD)
4	Output	Data Terminal Ready (DTR)
5	-----	Signal Ground (SG)
6	Input	Data Set Ready (DSR)
7	Input	Request To Send (RTS)
8	Output	Clear To Send (CTS)
9	-----	No Connection

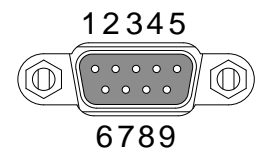

**NOTE** Do Not connect wire to pin 9 as it is specifically used for update function by certified factories.

**RS-232  
Connection**

GVM-9102 provides the complete RS-232 signals control. Select the corresponding null-modem cable, which has the DB-9 female connectors on both ends, when the port of DB-9 male connector on PC is utilized. The connecting diagram is shown as the following figure where the pin 2 (Tx) crossly links with the pin 3 (RxD) and the pin 5 (GND) is the necessary connection.

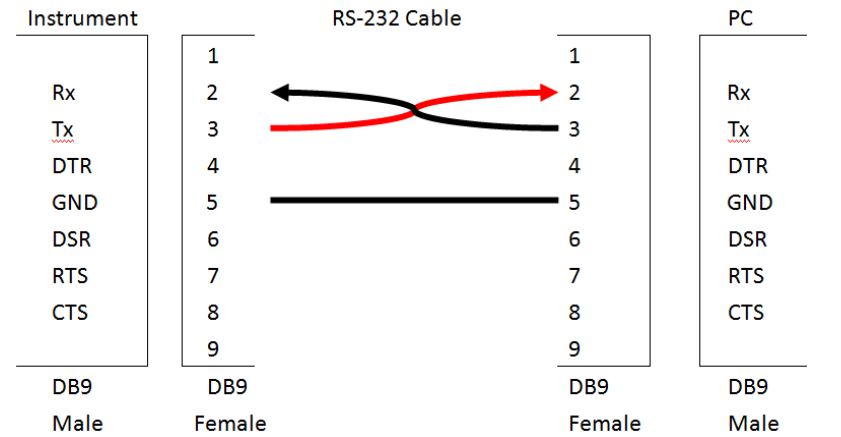

**GTL-234  
Connection**

An example below when optional accessory GTL-234 is being employed. Likewise, first crossly link the pin 2 (Tx) to the pin 3 (RxD) and the pin 5 (GND) is the necessary connection. Furthermore, crossly link the pin 7 (RTS) to pin 8 (CTS) for advanced function of GTL-234.

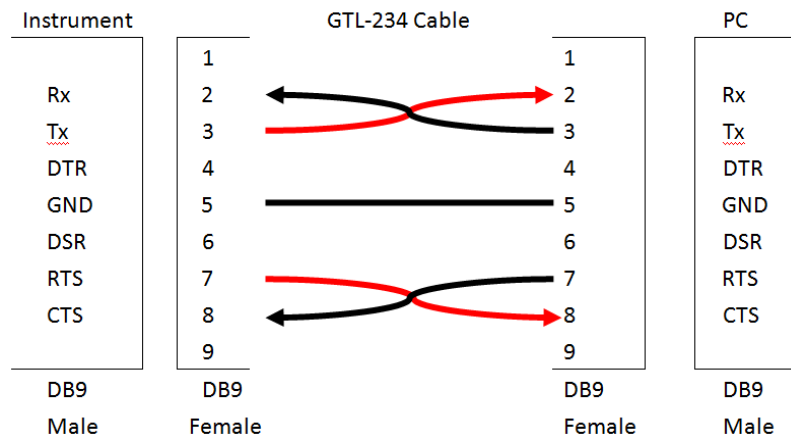

**More Connections**

If more other cables are applied, the diagram of full connections is illustrated as the following figure where the pin 2 (TxD), pin 3 (RxD) as well as pin 5 (GND), as mentioned previously, are necessary whilst the pin 4 (DTR), pin 6 (DSR), pin 7 (RTS) and pin 8 (CTS) are optionally required depending on different cables with varied functions to be used.

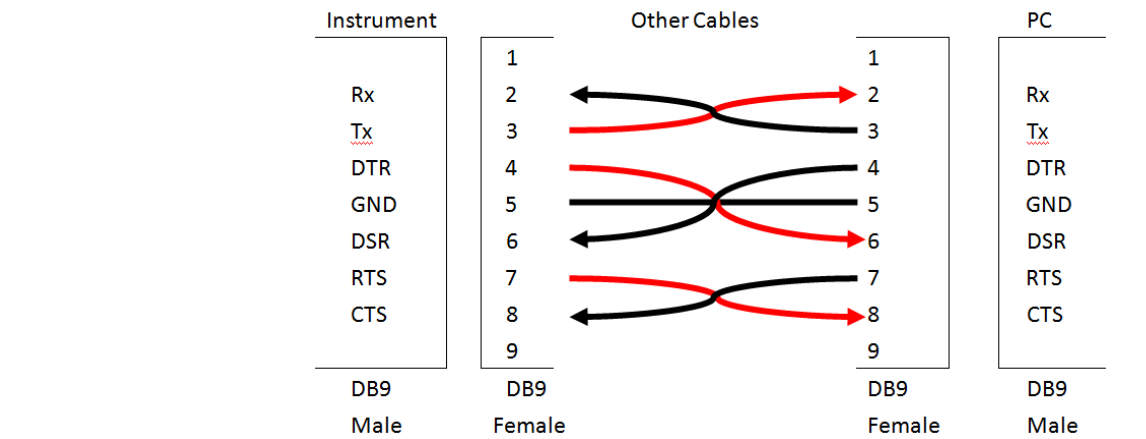

## Set the FlowCtrl handshake

---

**Description** The FlowCtrl configuration menu can set the handshake for return messages.

---

## Set the EOL Character

---

**Description** The TX TERM configuration menu can set the EOL (end-of-line) character for return messages.

The EOL characters that can be received from the PC include CR+LF, LF+CR, CR or LF. The most common EOL character is CR+LF.



**NOTE**

The USBTMC, GPIB and LAN's EOL character is fixed with LF.

EOL CR+LF, LF+CR, CR, LF (default = CR+LF)

---

## Set the Separation Character

---

**Description** The TX TERM configuration menu can set the separation character for multiple return measurement values.

---



**NOTE**

The USBTMC, GPIB and LAN's separation character is fixed with comma.

---



## Insert GPIB Card (Optional)

Power Off

Turn the Power Off and take out the power cord.

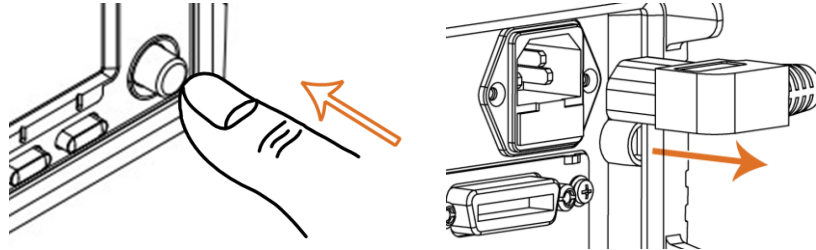

Open the GVM-9102 optional communication port

Take off the two screws on the slot corners to remove the optional communication port cover. Keep the screws for later reuse.

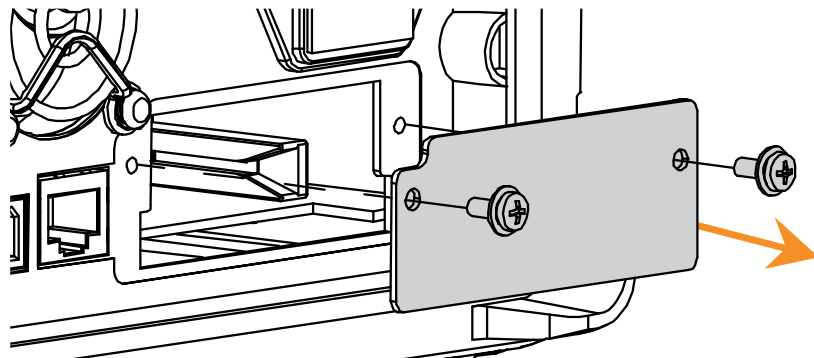

Insert the GPIB card

Insert the GPIB card into the slot. Close the cover by tightening the screws.

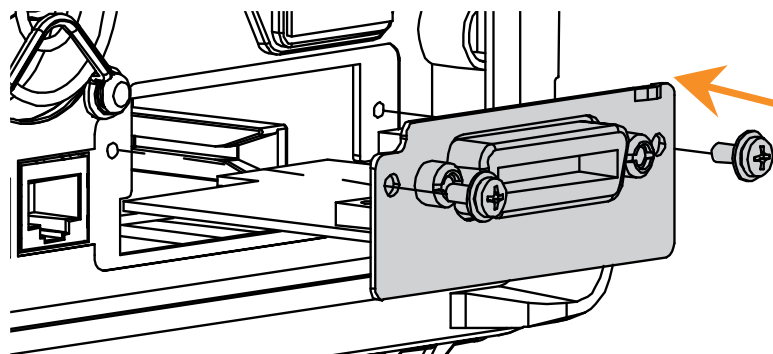

Power On

Connect the power cord and turn On the power.

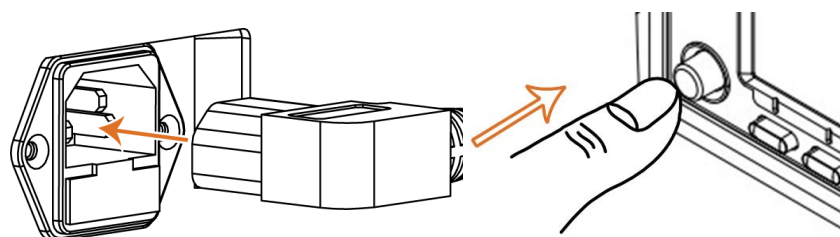

## Configure GPIB Interface

GPIB Configuration	Connector	24 Pin female GPIB port
	Address	0-30 (default 15)

- Step 1. Press the Menu key, and then the Page Down key repeatedly until the Interface configuration menu appears.

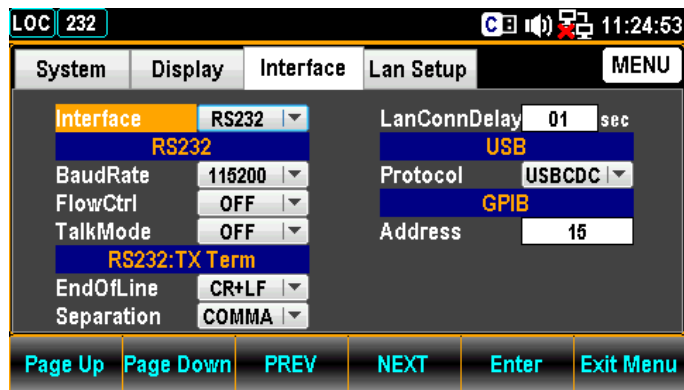
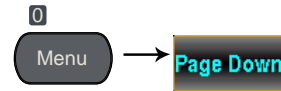

2. Press the F5 (Enter) key or Knob key followed by scrolling Knob key or pressing +/- keys to land on the GPIB option.

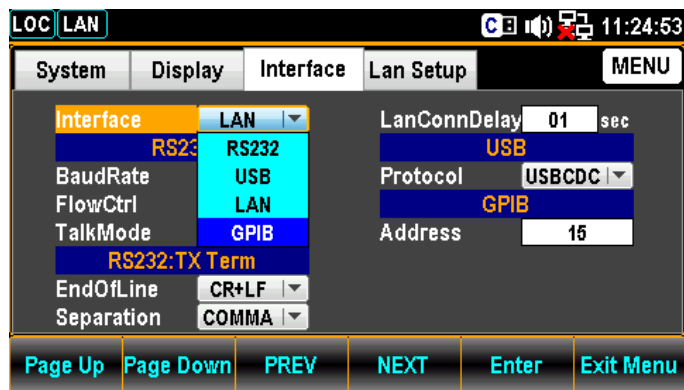
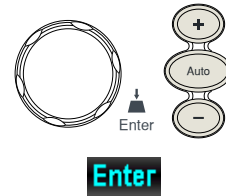



NOTE

As the figure shown below, GPIB option won't appear when optional GPIB card is not well installed.

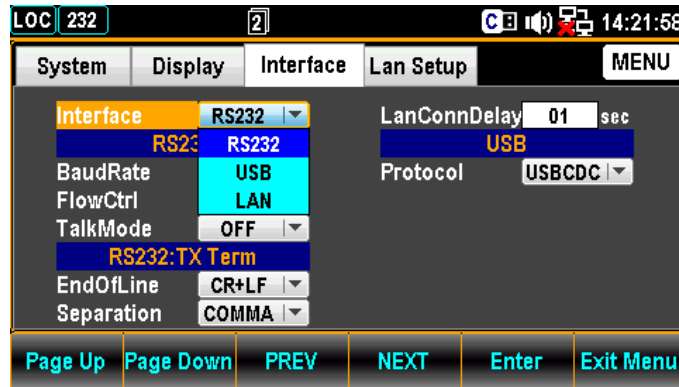

3. Press the F5 (Enter) key or Knob key to select the GPIB option.



4. Press the F4 (NEXT) key repeatedly or scroll the Knob key to move to the GPIB - Address field.

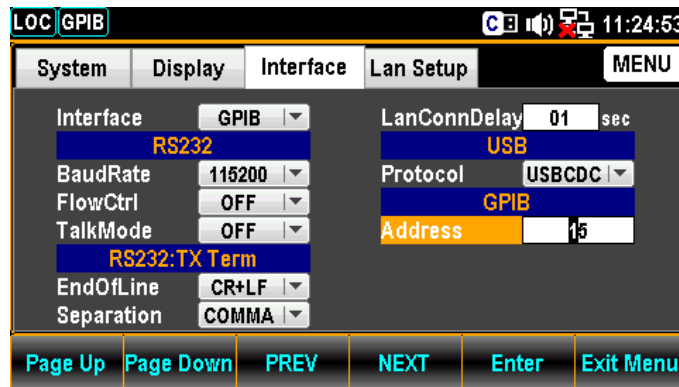

NOTE

As the figure shown below, the GPIB - Address field won't appear when optional GPIB card is not installed.

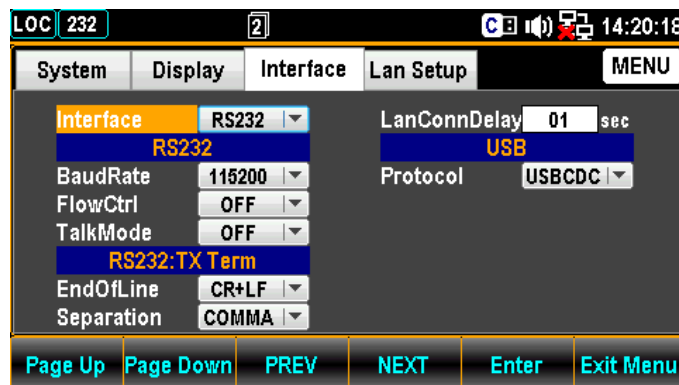

- Use the Left/Right keys to move the cursor followed by scrolling Knob key or pressing +/- keys to define GPIB Address. Also, you can press Number keys to directly input a specific digit.

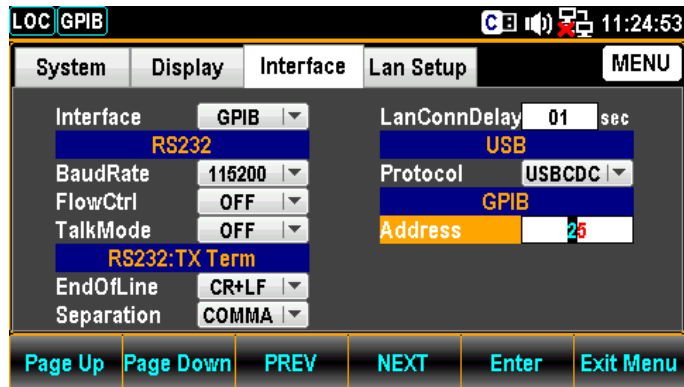
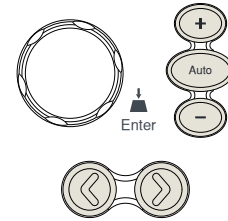

- Press the F5 (Enter) key or Knob key again to confirm the input digit for GPIB Address.

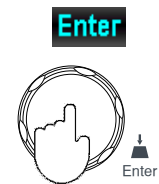

7. Connect the GPIB cable to the rear panel optional communication port after the GPIB card has been installed.

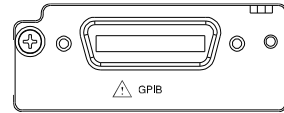

**GPIB Pin Assignment**

Pin	Signal	Pin	Signal
1	Data I/O 1	13	Data I/O 5
2	Data I/O 2	14	Data I/O 6
3	Data I/O 3	15	Data I/O 7
4	Data I/O 4	16	Data I/O 8
5	EOI	17	REN
6	DAV	18	Ground (DAV)
7	NRFD	19	Ground (NRFD)
8	NDAC	20	Ground (NDAC)
9	IFC	21	Ground (IFC)
10	SRQ	22	Ground (SRQ)
11	ATN	23	Ground (ATN)
12	SHIELD Ground	24	Single GND

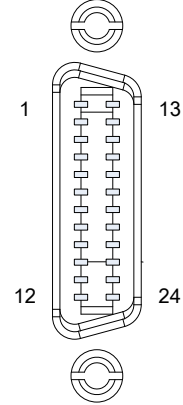

## Activate Ethernet Interface

Overview

Speed

10 Base T/100 Base Tx

Ethernet(LAN)  
port activation

1. Press the Menu key, and then the Page Down key repeatedly until the Interface configuration menu appears.

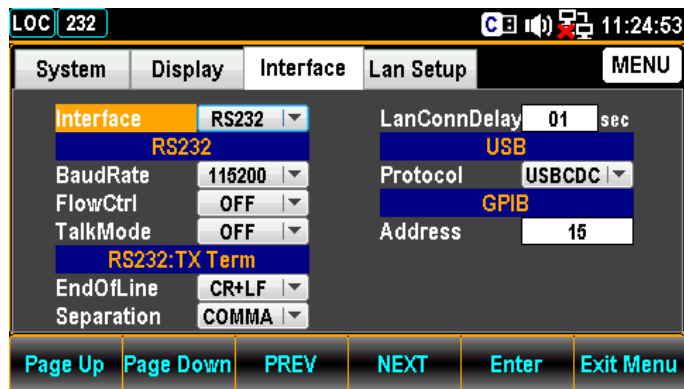
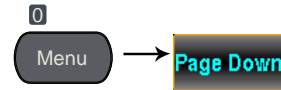

2. Press the F5 (Enter) key or Knob key followed by scrolling Knob key or pressing +/- keys to land on the LAN option.

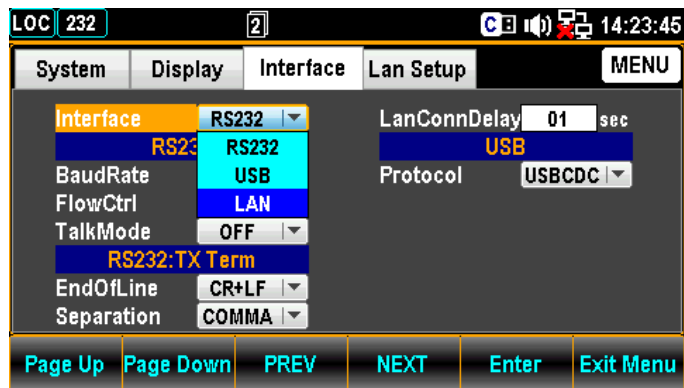
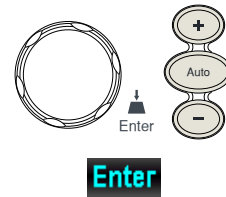

3. Press the F5 (Enter) key or Knob key to select the LAN option.

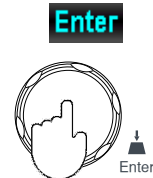

4. Connect the Ethernet cable to the rear panel Ethernet port.

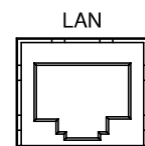

## LAN Connect Delay Time

**Background** User can set a delay time in second(s) for LAN connection when booting up the GVM-9102.

### LAN Connect Delay Setting

1. Press the Menu key, and then the Page Down key repeatedly until the Interface configuration menu appears.

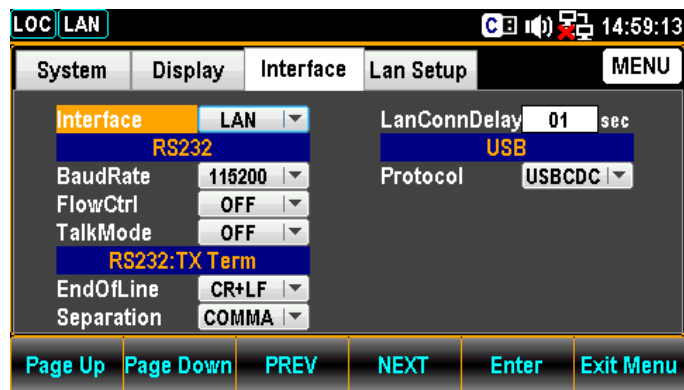
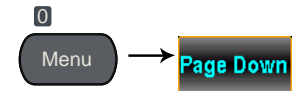

2. Press the F4 (NEXT) key repeatedly or scroll the Knob key to move to LAN Connect Delay Time.

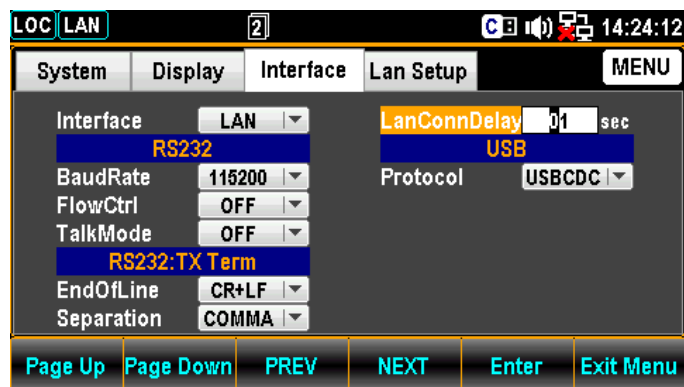

- Use the Left/Right keys to move the cursor followed by scrolling Knob key or pressing +/- keys to set LAN Connect Delay Time. Also, you can press Number keys to directly input a specific digit.

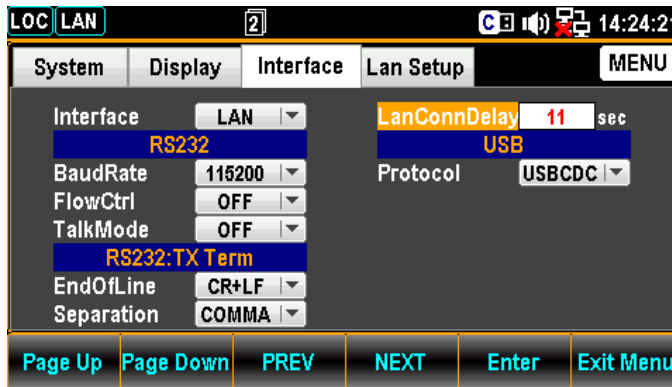
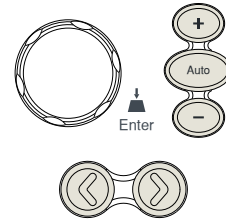

- Press the F5 (Enter) key or Knob key again to confirm the LAN Connect Delay Time.



## Reboot LAN Setup

### Background

To reboot is used to reset the Ethernet configuration when new settings have been made. When the Lan Setup settings have been edited, reboot to validate the changes and reset the Ethernet to the new configuration settings. New Ethernet configuration settings are only updated after the GVM-9102 has been reset.

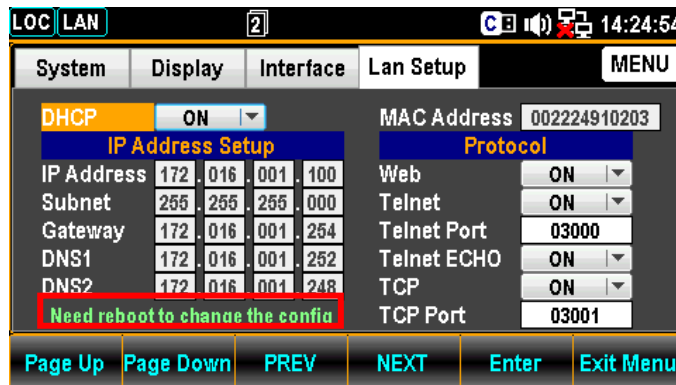



## Configure Ethernet Interface to DHCP

**Background** The GVM-9102 supports DHCP to have an IP address and other configuration parameters automatically assigned by a DHCP server.

**DHCP Configuration**

1. Press the Menu key, and then the Page Down key repeatedly until the Lan Setup configuration menu appears.

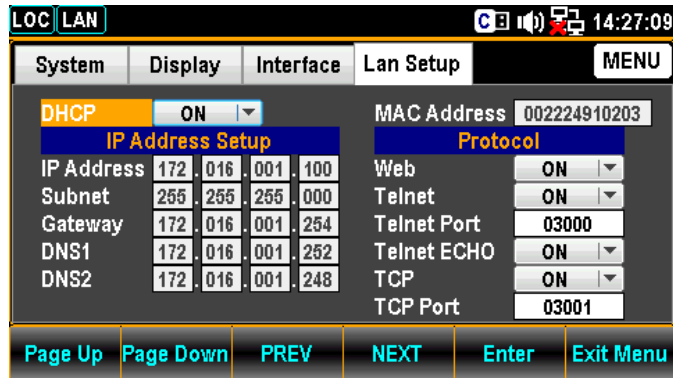
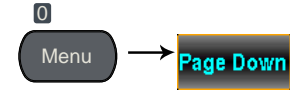

2. Press the F5 (Enter) key or Knob key followed by scrolling Knob key or pressing +/- keys to land on the ON option.

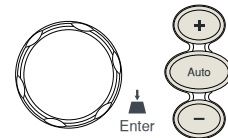

**Enter**

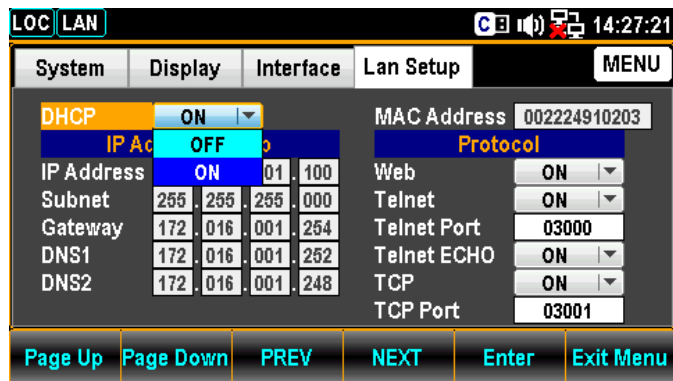

3. Press the F5 (Enter) key or Knob key to select the DHCP ON option.

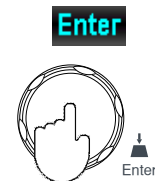

## Configure Ethernet IP

**Background** The GVM-9102 supports manually setting of the IP addresses, including the subnet mask, gateway, DNS1 and DNS2.



**NOTE**

The IP Address Setup can only be edited if DHCP is off.

### IP Address Configuration

1. Press the Menu key, and then the Page Down key repeatedly until the Lan Setup configuration menu appears.

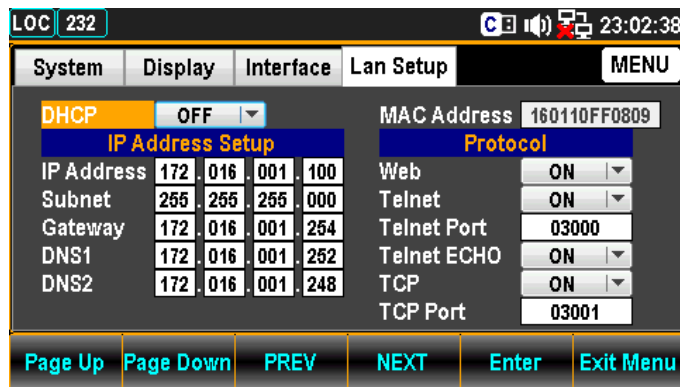

2. Press the F4 (NEXT) key repeatedly or scroll the Knob key to move to the IP Address Setup – IP Address field.

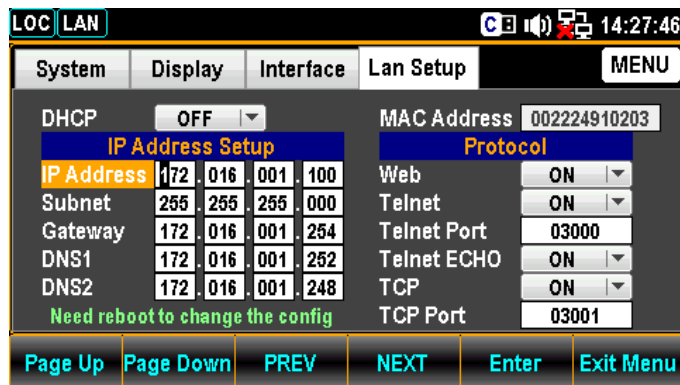

- Use the Left/Right keys to move the cursor followed by scrolling Knob key or pressing +/- keys to define IP Address. Also, you can press Number keys to directly input a specific digit.

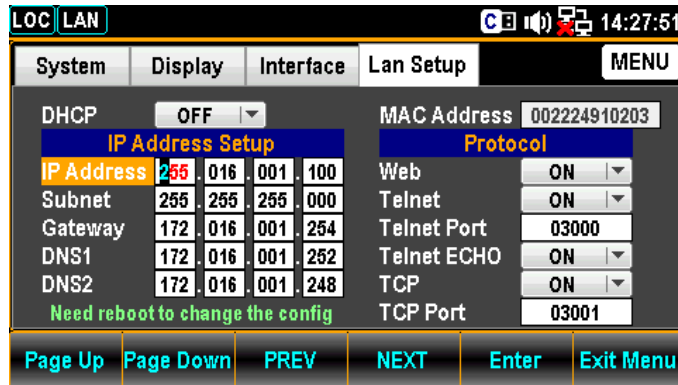
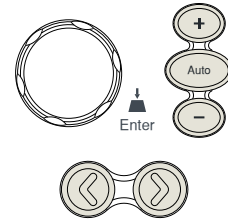

- Press the F5 (Enter) key or Knob key to confirm the input digit for IP1 Address. And the cursor will automatically jump to next groups.



- Repeat the steps 3 to 4 for IP2, IP3 and IP4.



NOTE

The IP address is divided in 4 groups; IP1:IP2:IP3:IP4.

Subnet Configuration

- Press the F4 (NEXT) key repeatedly or scroll the Knob key to move to the IP Address Setup – Subnet field.

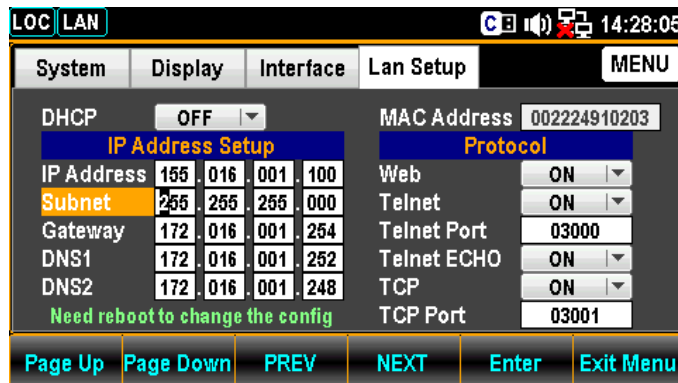
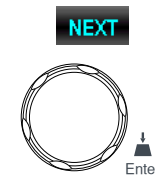

- Use the Left/Right keys to move the cursor followed by scrolling Knob key or pressing +/- keys to define Subnet. Also, you can press Number keys to directly input a specific digit.

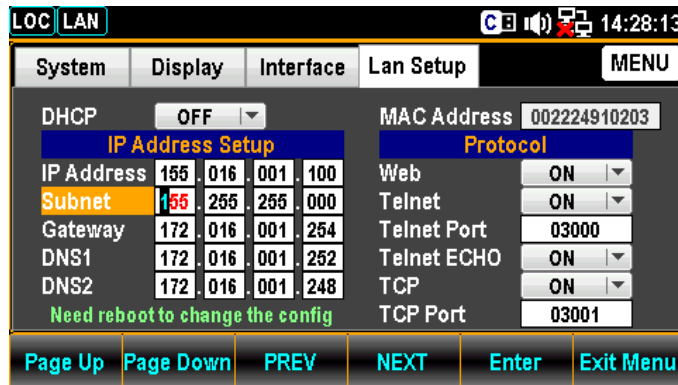
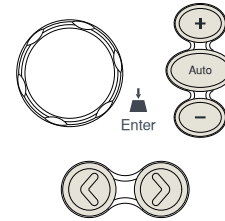

- Press the F5 (Enter) key or Knob key again to confirm the input digit for S1. And the cursor will automatically jump to next groups.

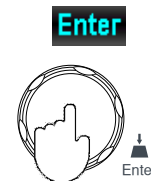

- Repeat steps 7 to 8 for S2, S3 and S4.



NOTE

The Subnet is divided in 4 groups; S1:S2:S3:S4.

Gateway Configuration

- Press the F4 (NEXT) key repeatedly or scroll the Knob key to move to the IP Address Setup – Gateway field.

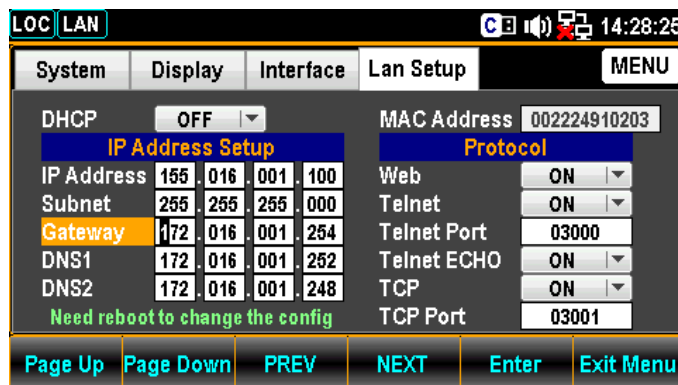
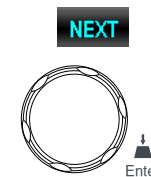

- Use the Left/Right keys to move the cursor followed by scrolling Knob key or pressing +/- keys to define Gateway. Also, you can press Number keys to directly input a specific digit.

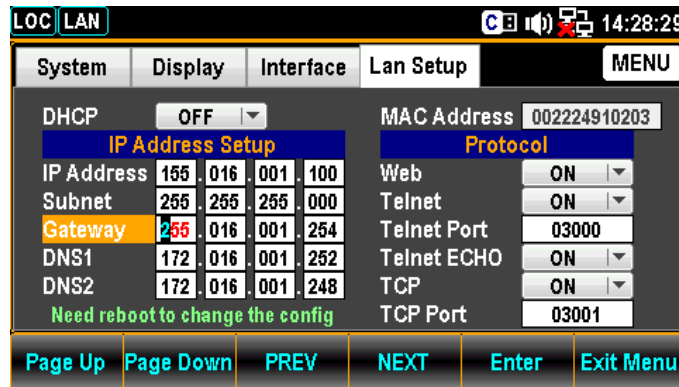
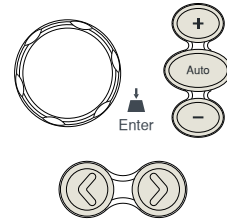

- Press the F5 (Enter) key or Knob key to confirm the input digit for G1. And the cursor will automatically jump to next groups.



- Repeat steps 11 to 12 for G2, G3 and G4.



NOTE

The Gateway is divided in 4 groups; G1:G2:G3:G4.

DNS1 Configuration

- Press the F4 (NEXT) key repeatedly or scroll the Knob key to move to the IP Address Setup – DNS1 field.

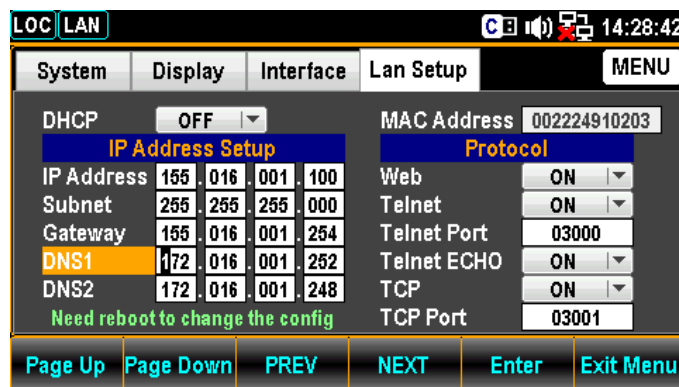

15. Use the Left/Right keys to move the cursor followed by scrolling Knob key or pressing +/- keys to define DNS1. Also, you can press Number keys to directly input a specific digit.

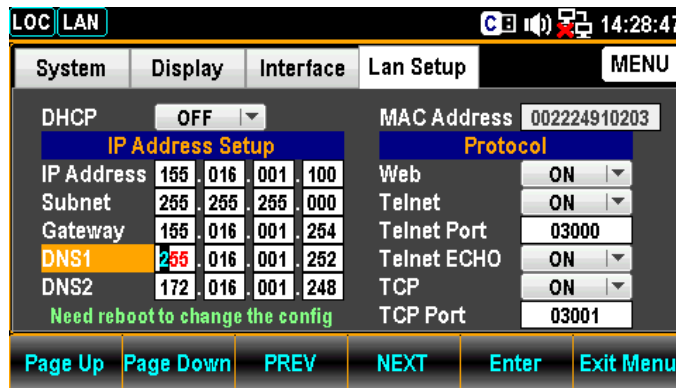
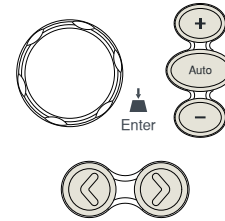

16. Press the F5 (Enter) key or Knob key again to confirm the input digit for D11. And the cursor will automatically jump to next groups.

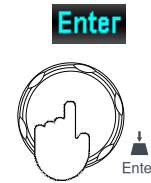

17. Repeat steps 15 to 16 for D12, D13 and D14.



NOTE

The Gateway is divided in 4 groups; D11:D12:D13:D14.

DNS2 Configuration

18. Press the F4 (NEXT) key repeatedly or scroll the Knob key to move to the IP Address Setup – DNS2 field.

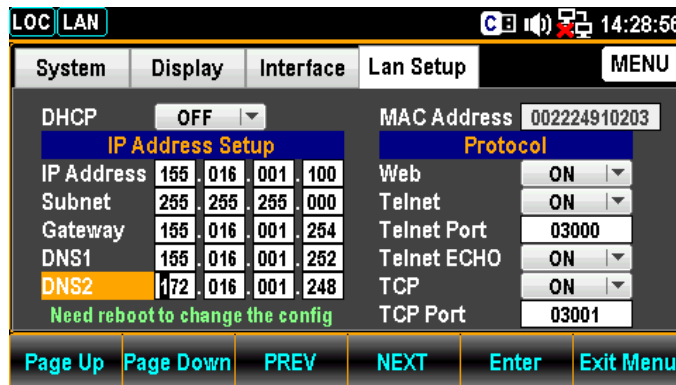
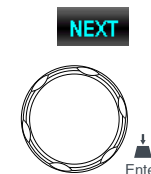

19. Use the Left/Right keys to move the cursor followed by scrolling Knob key or pressing +/- keys to define DNS2. Also, you can press Number keys to directly input a specific digit.

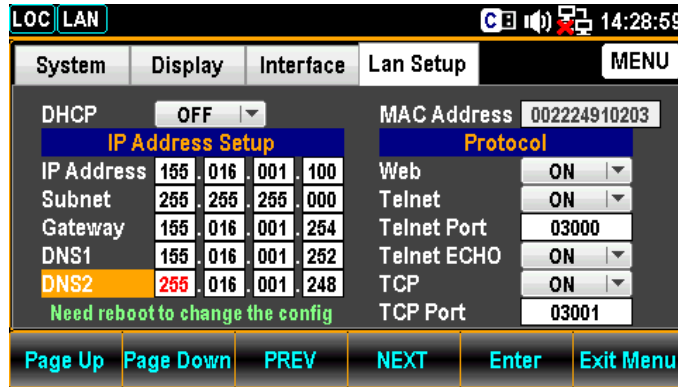
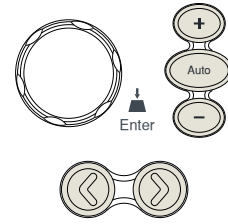

20. Press the F5 (Enter) key or Knob key again to confirm the input digit for D21. And the cursor will automatically jump to next groups.



21. Repeat steps 20 to 21 for D22, D23 and D24.



NOTE

The Gateway is divided in 4 groups; D21:D22:D23:D24.

## Configure Protocol

### Background

The GVM-9102 supports 3 Ethernet protocol to used, including the Web browser, Telnet and TCP.

### Web Configuration

1. Press the Menu key, and then the Page Down key repeatedly until the Lan Setup configuration menu appears.

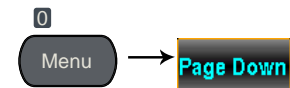

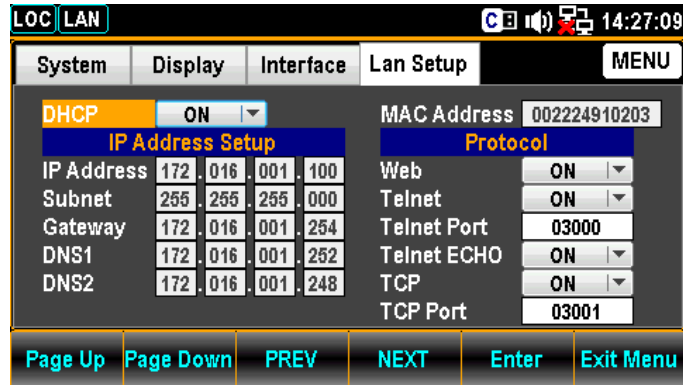

- Press the F4 (NEXT) key repeatedly or scroll the Knob key to move to the Protocol – Web field.

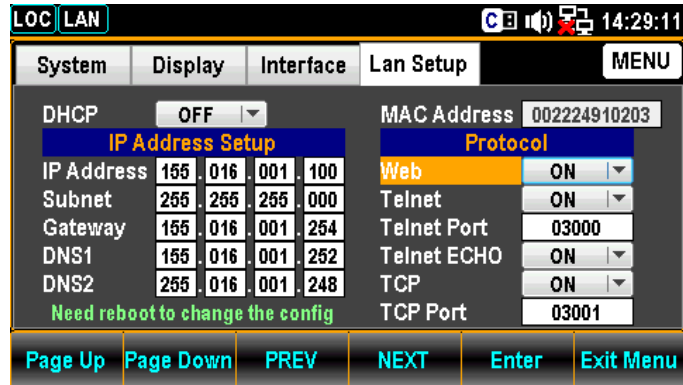
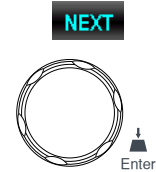

- Press the F5 (Enter) key or Knob key followed by scrolling Knob key or pressing +/- keys to land on the ON option.

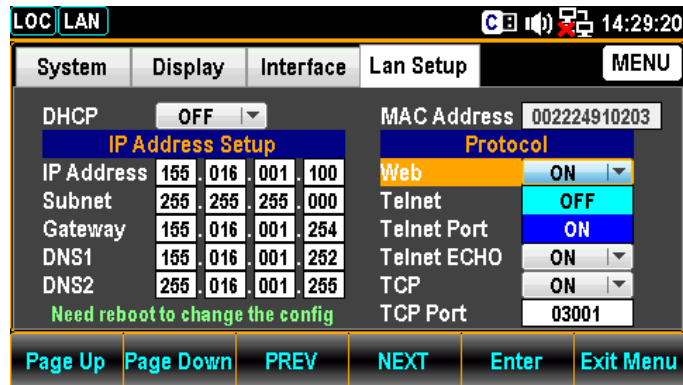
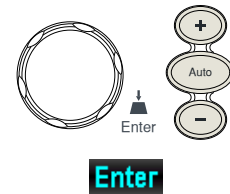



- Press the F5 (Enter) key or Knob key to confirm the Web ON option.

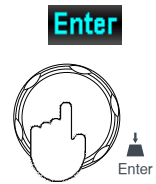

Telnet Configuration

- Press the F4 (NEXT) key repeatedly or scroll the Knob key to move to the Protocol – Telnet field.

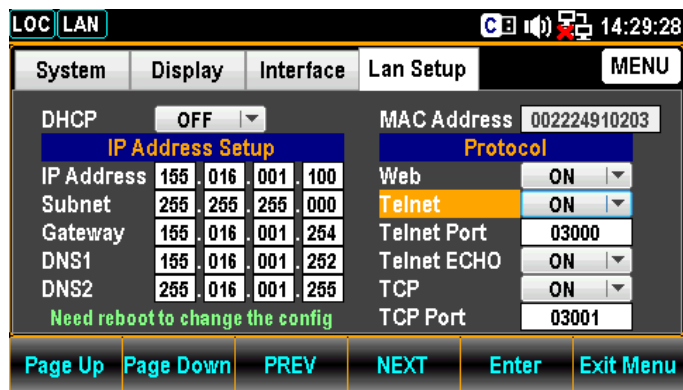
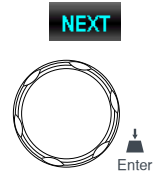

- Press the F5 (Enter) key or Knob key followed by scrolling Knob key or pressing +/- keys to land on the ON option.

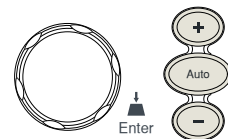

**Enter**

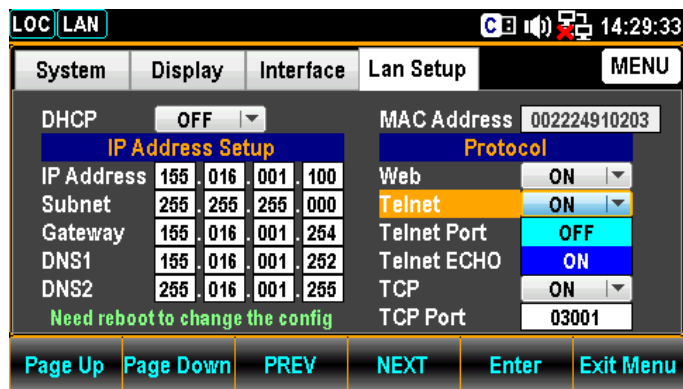

- Press the F5 (Enter) key or Knob key to confirm the Telnet ON option.



Telnet Port Configuration

- Press the F4 (NEXT) key repeatedly or scroll the Knob key to move to the Protocol – Telnet Port field.

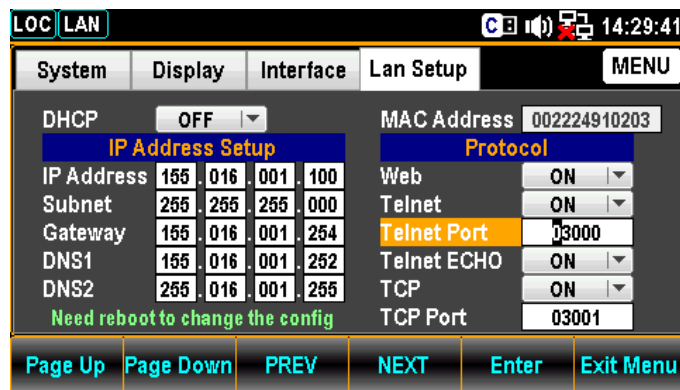

- Use the Left/Right keys to move the cursor followed by scrolling Knob key or pressing +/- keys to define Telnet Port. Also, you can press Number keys to directly input a specific digit.

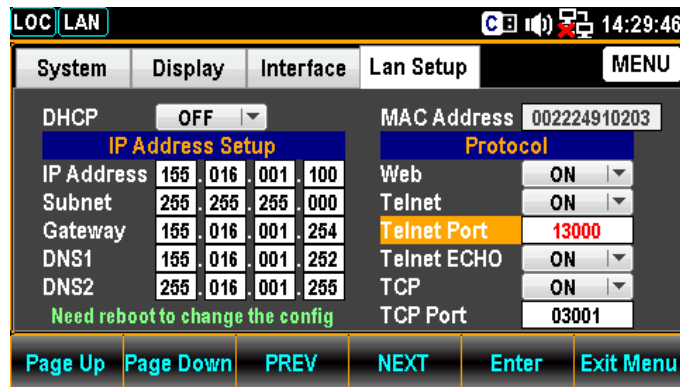
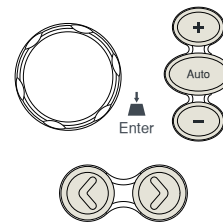

10. Press the F5 (Enter) key or Knob key to confirm the input digit for Telnet Port.

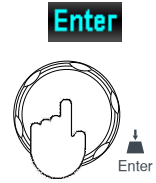

Range 1024~65535(Default = 3000)

Telnet ECHO Configuration

11. Press the F4 (NEXT) key repeatedly or scroll the Knob key to move to the Protocol – Telnet ECHO field.

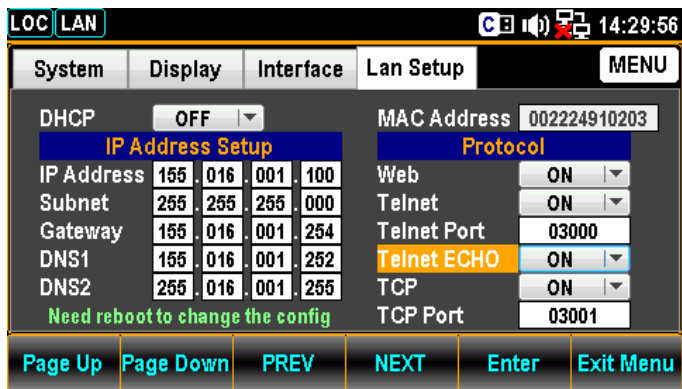
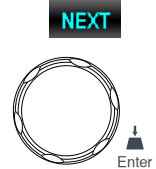

12. Press the F5 (Enter) key or Knob key followed by scrolling Knob key or pressing +/- keys to land on the ON option.

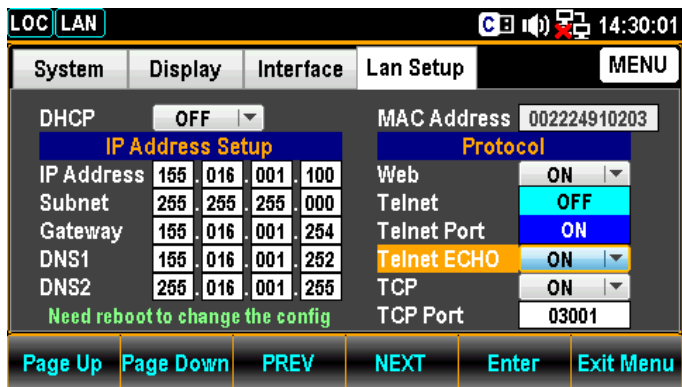
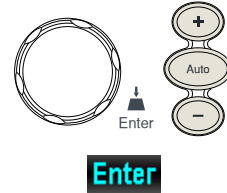

13. Press the F5 (Enter) key or Knob key again to confirm the Telnet ECHO ON option.



- TCP Configuration 14. Press the F4 (NEXT) key repeatedly or scroll the Knob key to move to the Protocol - TCP field.

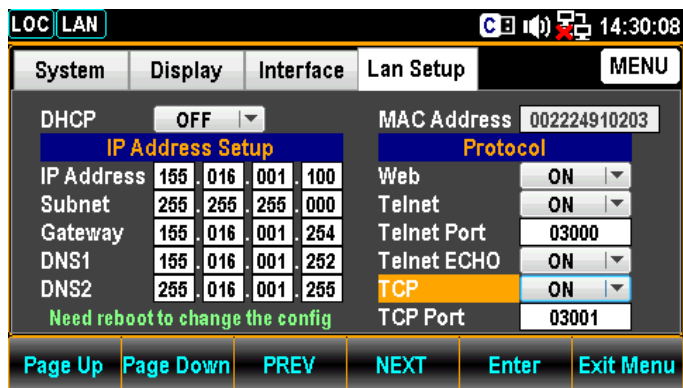
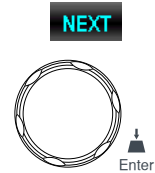

15. Press the F5 (Enter) key or Knob key followed by scrolling Knob key or pressing +/- keys to land on the ON option.

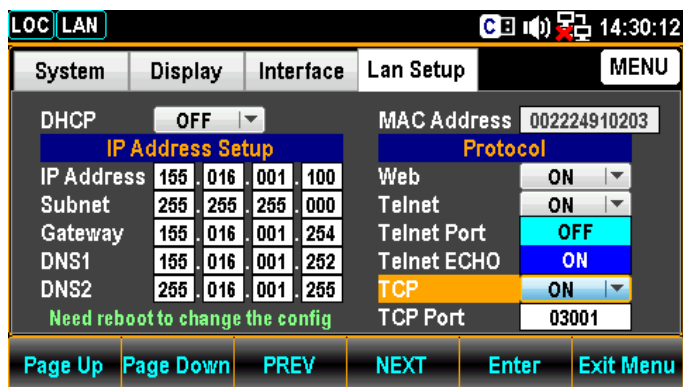
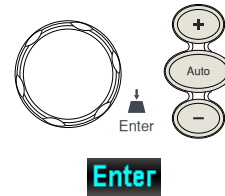

16. Press the F5 (Enter) key or Knob key again to confirm the TCP ON option

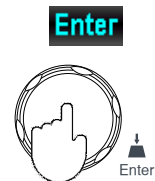

TCP Port Configuration

17. Press the F4 (NEXT) key repeatedly or scroll the Knob key to move to the Protocol – TCP Port field.

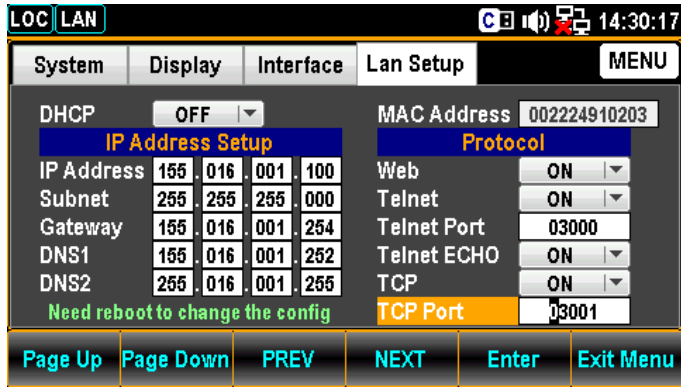
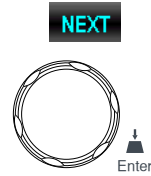

18. Use the Left/Right keys to move the cursor followed by scrolling Knob key or pressing +/- keys to define TCP Port. Also, you can press Number keys to directly input a specific digit.

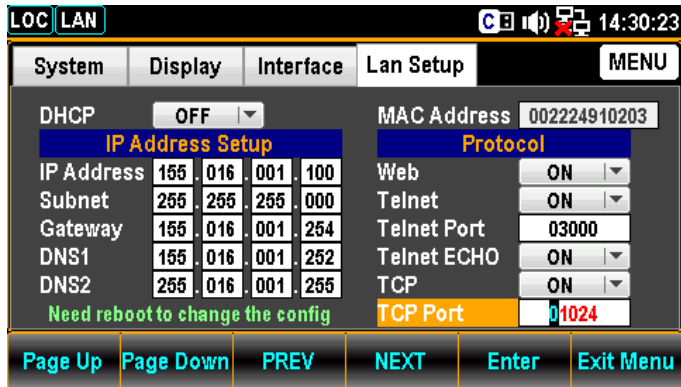
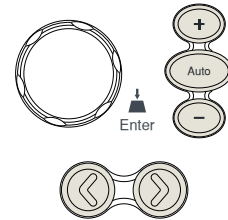

Range 1024~65535(Default = 3001)

19. Press the F5 (Enter) key or Knob key again to confirm the input digit for TCP Port.



## Remote Terminal Session (Telnet / TCP)

---

Background	A terminal application can be used to remotely control the GVM-9102 via the Telnet or TCP protocol.
Operation	<ol style="list-style-type: none"><li>1. Establish a connection via the Ethernet port.</li><li>2. Open a terminal program such as Hyper Terminal and enter the IP address and port number of the GVM-9102.</li><li>3. Run this query via the terminal application: *idn?  The command will return the instrument manufacturer, model number, serial number and firmware version in the following format: &gt;GWInstek,GVM9102,000000000,M0.69B_S0.25B</li><li>4. See page 188 for more details on remote commands.</li></ol>

# Web Control Interface

The web control interface is accessible with the standard Ethernet port. The web control interface allows remote access over LAN using a Java-enabled web browser (Java only applicable to Internet Explorer).

The web control interface allows a web browser to modify parameter settings, remotely operate, control and monitor the GVM-9102.

Telnet and TCP parameters can also be edited by using the web control interface so that applets such as HyperTerminal or Telnet can be used to monitor measurement readings, control settings and run programs utilizing the same remote control command set used with the RS232 remote control.

Background	Before trying to access the web browser control interface, please ensure your browser has JavaScript enabled.
Step 1 - Connection	<ol style="list-style-type: none"> <li>1. Configure the LAN interface and connect the GVM-9102 to the LAN..</li> <li>2. Enter the IP address of the GVM-9102 in the address field of the web browser.</li> <li>3. The web control Welcome Page appears.</li> </ol>





**GVM9102 6 1/2 Digit 2kV DC Voltmeter**

---

**FEATURES**

- ◎ 6 1/2 Digit Display : 2,400,000 counts
- ◎ The Highest Voltage: 2000V
- ◎ The Highest DCV Accuracy: 100ppm
- ◎ 4.3" TFT LCD(480x272)
- ◎ Multi Functions:DCV, REL, MX+B, Compare and Statistics
- ◎ USB Storage (Capture ScreenShot and Save Measurement Data)
- ◎ Graphic Display (BarMeter, TrendChart, Histogram)
- ◎ High Measurement Speed: Up to 10,000 readings/second
- ◎ Standard Interfaces : USB(CDC or TMC), RS232C, LAN, Digital I/O
- ◎ Optional Interfaces : GPIB

GVM-9102 Welcome Page

Step 2 -  
Web Control

1. To start web control, click on the Web Control icon.
2. The control page appears, a dialog box will appear prompting for a password. Input the password (default password: 12345678) if Lan password has been enabled previously.



**GW INSTEK** Good Will Instrument Co., Ltd.

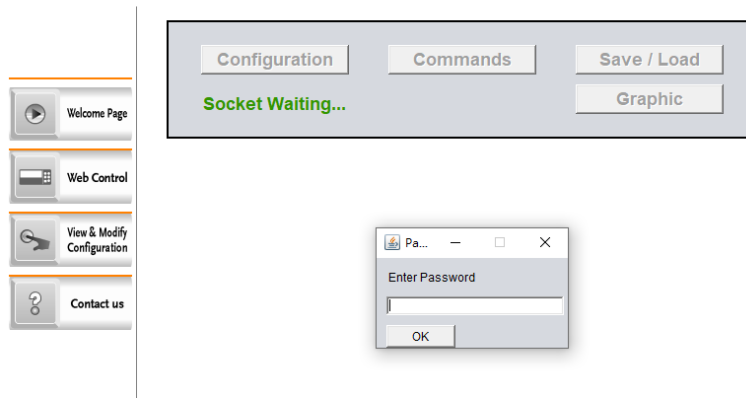

Step 2-1 -  
Configuration

3. Setting the basic operations and monitor measurement readings, press apply button to enable the control settings when parameters have changed.

**GW INSTEK** Good Will Instrument Co., Ltd.

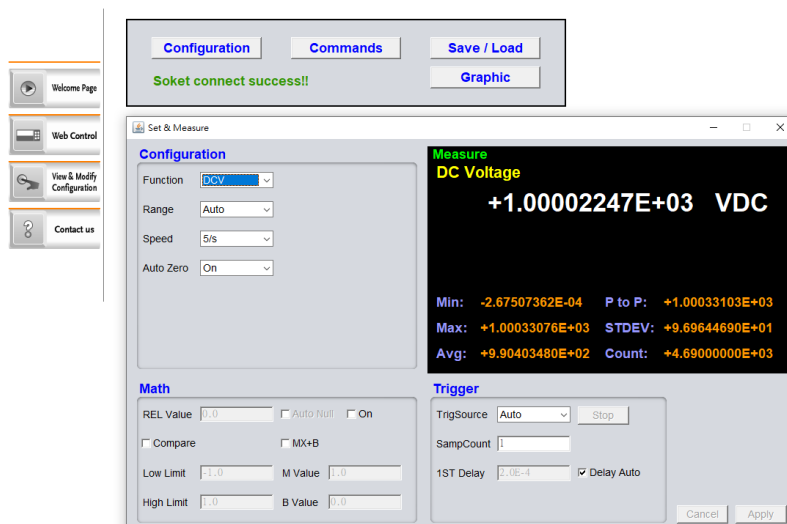



- Step 2-2 - Command 4. It is available for remote control by manually inputting the command sets.

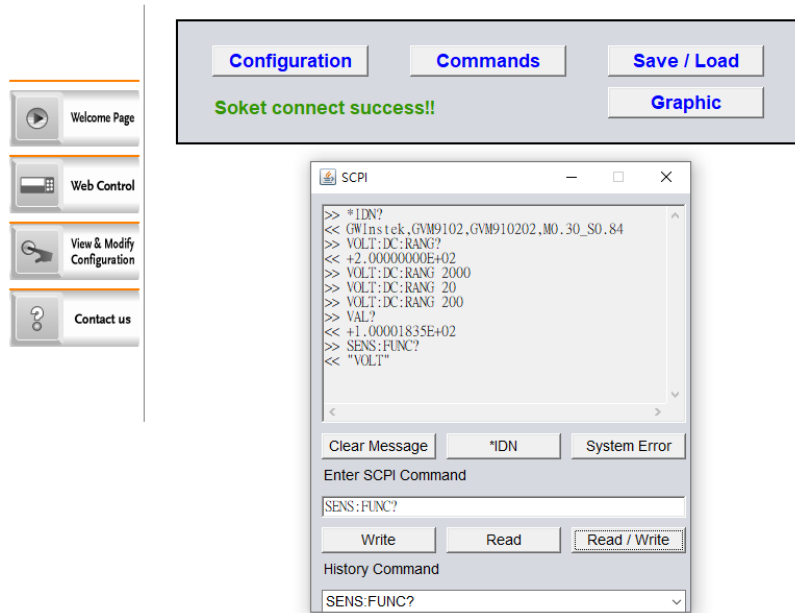

- Step 2-3 - Save / Load 5. Also, to save and load the multiple settings of parameters are available.

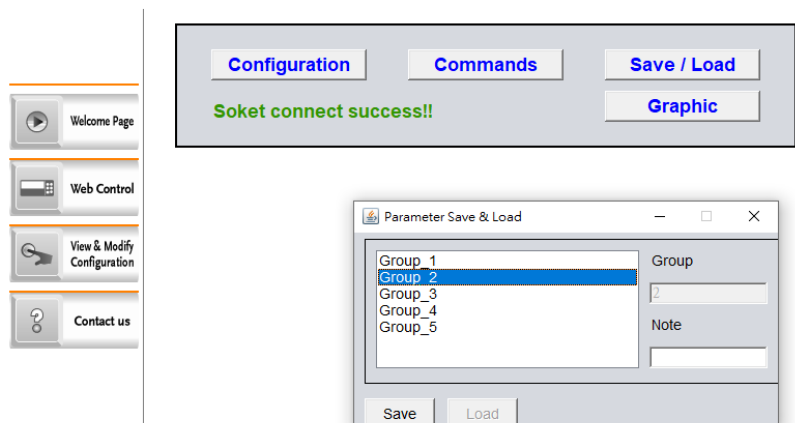

Step 2-4 -  
Graphic

- Several graphic display modes are available. To change different display modes, press the “Apply” button followed by clicking the “Get Picture” button to update to the desired display mode.

Number display

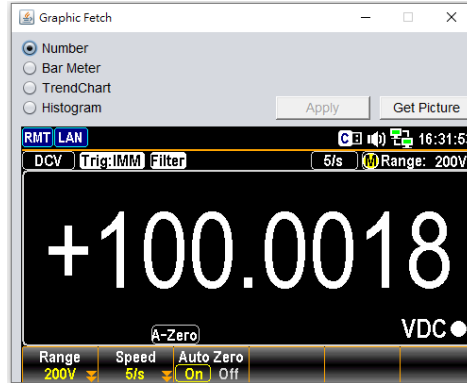

Bar display

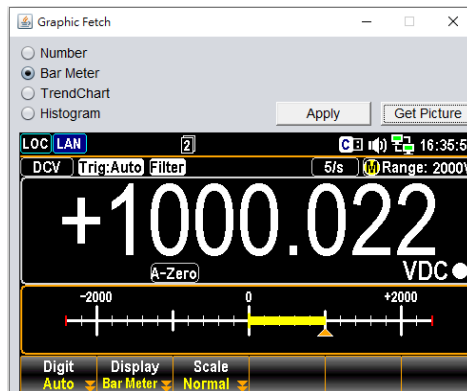

Trend Chart display

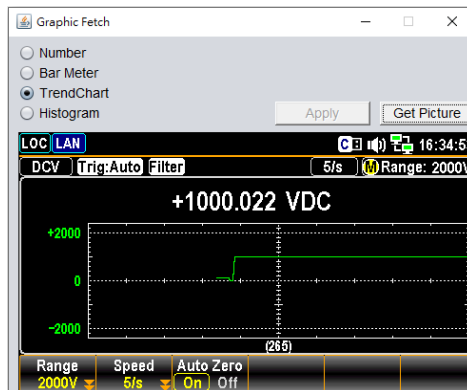

Histogram display

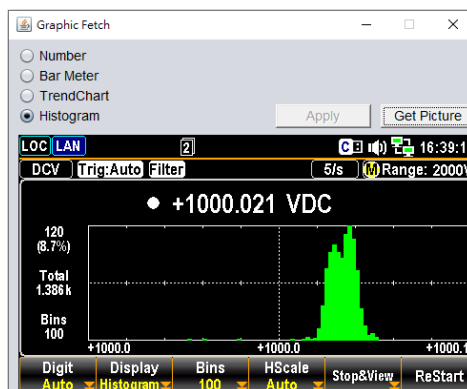

Step 3 -  
View and Modify  
LAN Configuration

The current Ethernet settings can be viewed and modified from the web control interface.

1. To edit or view the current configuration settings, click on the View & Modify Configuration icon.



2. The configuration settings appear.

**Miscellaneous Settings**

Name:	GVM
Serial Number:	GVM910202
Master Firmware:	0.30
Slave Firmware:	0.84
IP Address:	192.168.38.123
MAC Address:	00-22-24-91-02-02

**IP Address Settings**

Address Type:	DHCP ▾
Static IP Address:	192 . 168 . 38 . 123
Subnet Mask:	255 . 255 . 240 . 0
Default Gateway:	192 . 168 . 39 . 254
DNS:	172 . 16 . 1 . 248 , 172 . 16 . 1 . 252
<input type="button" value="Update Settings"/>	

**General Configuration Settings**

Module Name:	GVM
TCP Enable:	ON ▾
TCP port number:	5025 (1024~65535)
Telnet Enable:	ON ▾
Telnet port number:	5024 (1024~65535)
Telnet ECHO:	ON ▾
Telnet Timeout:	0 seconds(0 for no timeout)
<input type="button" value="Update Settings"/>	

**Password Modify**

Old Password:	<input type="text"/>	(4-8 characters numeric)
New Password:	<input type="text"/>	(4-8 characters numeric)
Confirm Password:	<input type="text"/>	
<input type="button" value="Modify"/>		

**Restore Factory Defaults**

Restore all options to their factory default states:	<input type="button" value="Restore Defaults"/>
--	---

**GVM Reset**

GVM need Reset If Parameter has Change:	<input type="button" value="Reset"/>
---	--------------------------------------

3. The View & Modify Configuration page allows you to:
  - View the instrument name, firmware revision of the Ethernet card, IP address and MAC address.
  - Set the IP address to DHCP or static.
  - Configure the module host name and the parameters of TCP & telnet.
  - Modify the web password.
  - Restore the Ethernet to the factory default settings (equivalent to the INIT function).
  - Reset: reboot to make the new setting take effect when any parameter is modified.

## Command Syntax

---

Compatible Standard	IEEE488.2	Partial compatibility
	SCPI, 1994	Partial compatibility

**Command Structure** SCPI (Standard Commands for Programmable Instruments) commands follow a tree-like structure, organized into nodes. Each level of the command tree is a node. Each keyword in a SCPI command represents each node in the command tree. Each keyword (node) of a SCPI command is separated by a colon (:).

For example, the diagram below shows an SCPI sub-structure and a command example.

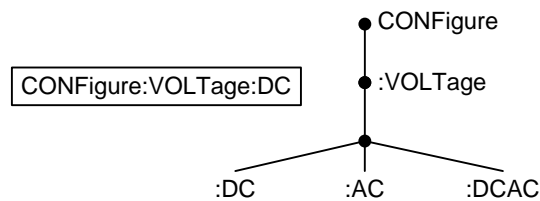

**Command Types** There are a number of different instrument commands and queries. A command sends instructions or data to the unit and a query receives data or status information from the unit.

### Command types

**Simple** A single command with/without a parameter

**Example** CONFigure:VOLTage:DC

**Query**      A query is a simple or compound command followed by a question mark (?). A parameter (data) is returned.

**Example**      CONFigure:RANGe?

**Command Forms**      Commands and queries have two different forms, long and short. The command syntax is written with the short form of the command in capitals and the remainder (long form) in lower case.

The commands can be written either in capitals or lower-case, just so long as the short or long forms are complete. An incomplete command will not be recognized.

Below are examples of correctly written commands.

Long form

CONFigure:VOLTage:DC  
 CONFIGURE:VOLTAGE:DC  
 Configure:voltage:dc

Short form      CONF:VOLT:DC  
 conf:volt:dc

**Square Brackets**      Commands that contain square brackets indicate that the contents are optional. The function of the command is the same with or without the square bracketed items, as shown below. For example, for the query:

[SENSe:]DATA?

Both SENSe:DATA? and DATA? are valid forms.

**Command Format**

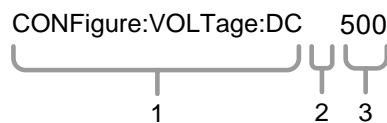

- 1. Command header
- 2. Space
- 3. Parameter 1

Common Input Parameters	Type	Description	Example
	<Boolean>	boolean logic	0, 1
	<NR1>	integers	0, 1, 2, 3
	<NR2>	decimal numbers	0.1, 3.14, 8.5

<NR3>	floating point with exponent	4.5e-1, 8.25e+1
<NRf>	any of NR1, 2, 3	1, 1.5, 4.5e-1
[MIN] (Optional parameter)	<p>For commands, this will set the setting to the lowest value. This parameter can be used in place of any numerical parameter where indicated.</p> <p>For queries, it will return the lowest possible value allowed for the particular setting.</p>	
[MAX] (Optional parameter)	<p>For commands, this will set the setting to the highest value. This parameter can be used in place of any numerical parameter where indicated.</p> <p>For queries, it will return the highest possible value allowed for the particular setting.</p>	
DEF	<p>For commands, this will set the setting to the default value. This parameter can be used in place of any numerical parameter where indicated.</p> <p>For queries, it will return the default value allowed for the particular setting.</p>	

**Automatic parameter range selection**      The GVM-9102 automatically sets the command parameter to the next available value.

Example	conf:volt:dc 3
	<p>This will set the measurement item to DC Voltage and the range to 10V. There is no 3V range so the GVM selects the next available range, 10V.</p>

<b>Message Terminator (EOL)</b>	Remote Command	<p>Marks the end of a command line. The following messages are in accordance with IEEE488.2 standard.</p> <p>LF, CR, CR+LF, LF+CR</p> <p>The most common EOL character is CR+LF</p>
---------------------------------	----------------	---

<b>Message Separator</b>	EOL or ; (semicolon)	Command Separator
--------------------------	----------------------	-------------------

# Command Set

## Other Commands

ABORt .....	200
FETCh? .....	200
HCOPy:SDUMp:DATA? .....	200
INITiate[:IMMediate] .....	201
R? [<reading_number>].....	202
READ? .....	202
VAL1? .....	202
TIME:SYNC:SERVer .....	203
TIME:SYNC:SERVer? .....	203

## CALCulate Commands

CALCulate:CLear[:IMMediate] .....	203
CALCulate:DATA?.....	203
CALCulate:FUNcTion .....	203
CALCulate:FUNcTion? .....	203
CALCulate:STATe.....	203
CALCulate:STATe? .....	203
CALCulate:AVERage:ALL? .....	203
CALCulate:AVERage:AVERage? .....	204
CALCulate:AVERage:CLear[:IMMediate] .....	204
CALCulate:AVERage:COUNT? .....	204
CALCulate:AVERage:MAXimum? .....	204
CALCulate:AVERage:MINimum? .....	204
CALCulate:AVERage:PTPeak?.....	204
CALCulate:AVERage:SDEVIation? .....	204
CALCulate:AVERage[:STATe] .....	204
CALCulate:AVERage[:STATe]? .....	204
CALCulate:LIMit:CLear[:IMMediate] .....	204
CALCulate:LIMit:BEEPer:MODE .....	205
CALCulate:LIMit:BEEPer:MODE?.....	205
CALCulate:LIMit:DATA? .....	205
CALCulate:LIMit:LOWer[:DATA] .....	205

CALCulate:LIMit:LOWer[:DATA]? .....	205
CALCulate:LIMit:UPPer[:DATA] .....	205
CALCulate:LIMit:UPPer[:DATA]? .....	205
CALCulate:LIMit[:STATe] .....	205
CALCulate:LIMit[:STATe]? .....	205
CALCulate:MATH:MMFactor .....	206
CALCulate:MATH:MMFactor? .....	206
CALCulate:MATH:MBFactor .....	206
CALCulate:MATH:MBFactor? .....	206
CALCulate:TCHart[:STATe] .....	206
CALCulate:TCHart[:STATe]? .....	206
CALCulate:TRANSform:HISTogram[:STATe] .....	206
CALCulate:TRANSform:HISTogram[:STATe]? .....	206
CALCulate:TRANSform:HISTogram:ALL? .....	207
CALCulate:TRANSform:HISTogram:CLEar[:IMMediate] .....	207
CALCulate:TRANSform:HISTogram:COUNT? .....	207
CALCulate:TRANSform:HISTogram:DATA? .....	207
CALCulate:TRANSform:HISTogram:POINts .....	207
CALCulate:TRANSform:HISTogram:POINts? .....	207
CALCulate:TRANSform:HISTogram:RANGE:AUTO .....	208
CALCulate:TRANSform:HISTogram:RANGE:AUTO? .....	208
CALCulate:TRANSform:HISTogram:RANGE:LOWer .....	208
CALCulate:TRANSform:HISTogram:RANGE:LOWer? .....	208
CALCulate:TRANSform:HISTogram:RANGE:UPPer .....	208
CALCulate:TRANSform:HISTogram:RANGE:UPPer? .....	208
CALCulate:TRANSform:HISTogram[:STATe] .....	208
CALCulate:TRANSform:HISTogram[:STATe]? .....	208

## CONFigure Commands

CONFigure? .....	209
CONFigure[:VOLTage]:DC .....	209



## DATA Commands

DATA:LAST? .....	209
DATA:POINts?.....	209
DATA:POINts:EVENT:THReshold .....	209
DATA:POINts:EVENT:THReshold? .....	210
DATA:REMOve? <reading_number>,[WAIT].....	210

## DIGital INTerface Commands

DIGital:INTerface:MODE .....	210
DIGital:INTerface:MODE? .....	210
DIGital:INTerface:DATA:OUTPut.....	210
DIGital:INTerface:DATA:SETup.....	211

## DISPlay Commands

DISPlay[:STATe].....	211
DISPlay[:STATe]?.....	211
DISPlay:TEXT:CLEar .....	211
DISPlay:TEXT[:DATA] .....	211
DISPlay:TEXT[:DATA]? .....	211
DISPlay:VIEW .....	211
DISPlay:VIEW? .....	211

## MEASure Commands

MEASure[:VOLTage]:DC?.....	212
----------------------------	-----

## SENSe Related Commands

[SENSe:]FUNctIon .....	212
[SENSe:]FUNctIon? .....	212
[SENSe:]DATA? .....	212
[SENSe:]DIGital:SHIFt.....	212
[SENSe:]DIGital:SHIFt? .....	212

## SENSe AVERage Commands

[SENSe:]AVERage:COUNT .....	213
[SENSe:]AVERage:COUNT? .....	213
[SENSe:]AVERage:STATE .....	213
[SENSe:]AVERage:STATE? .....	213
[SENSe:]AVERage:TCONtrol.....	213
[SENSe:]AVERage:TCONtrol?.....	213
[SENSe:]AVERage:WINDow .....	213
[SENSe:]AVERage:WINDow? .....	213
[SENSe:]AVERage:WINDow:METhod .....	214
[SENSe:]AVERage:WINDow:METhod? .....	214

## SENSe VOLTage Commands

[SENSe:]VOLTage[:DC]:NPLCycles.....	214
[SENSe:]VOLTage[:DC]:NPLCycles? .....	214
[SENSe:]VOLTage[:DC]:NULL[:STATe] .....	214
[SENSe:]VOLTage[:DC]:NULL[:STATe]? .....	214
[SENSe:]VOLTage[:DC]:NULL:VALue .....	214
[SENSe:]VOLTage[:DC]:NULL:VALue? .....	214
[SENSe:]VOLTage[:DC]:NULL:VALue:AUTO .....	215
[SENSe:]VOLTage[:DC]:NULL:VALue:AUTO? .....	215
[SENSe:]VOLTage[:DC]:RANGe .....	215
[SENSe:]VOLTage[:DC]:RANGe?.....	215
[SENSe:]VOLTage[:DC]:RANGe:AUTO .....	215
[SENSe:]VOLTage[:DC]:RANGe:AUTO? .....	215
[SENSe:]VOLTage[:DC]:RESolution .....	215
[SENSe:]VOLTage[:DC]:RESolution?.....	215
[SENSe:]VOLTage[:DC]:TRIGger:DELay .....	215
[SENSe:]VOLTage[:DC]:TRIGger:DELay?.....	216
[SENSe:]VOLTage[:DC]:ZERO:AUTO .....	216
[SENSe:]VOLTage[:DC]:ZERO:AUTO? .....	216

## TRIGger Commands

SAMPlE:COUNT .....	216
SAMPlE:COUNT? .....	216
TRIGger:COUNT .....	216
TRIGger:COUNT? .....	216
TRIGger:DElAy .....	217
TRIGger:DElAy? .....	217
TRIGger:DElAy:AUTO .....	217
TRIGger:DElAy:AUTO? .....	217
TRIGger:SLOPe .....	217
TRIGger:SLOPe? .....	217
TRIGger:SOURce .....	218
TRIGger:SOURce? .....	219
OUTPut:TRIGger:SLOPe .....	219
OUTPut:TRIGger:SLOPe? .....	219

## SYSTem Related Commands

SYSTem:BEEPer[:IMMediate] .....	219
SYSTem:BEEPer:ERRor .....	219
SYSTem:BEEPer:ERRor? .....	219
SYSTem:BEEPer:STATe .....	219
SYSTem:BEEPer:STATe? .....	219
SYSTem:BEEPer:COMPare:VOLume .....	220
SYSTem:BEEPer:COMPare:VOLume? .....	220
SYSTem:CLICk:STATe .....	220
SYSTem:CLICk:STATe? .....	220
SYSTem:DATE .....	220
SYSTem:DATE? .....	220
SYSTem:DISPlay .....	220
SYSTem:DISPlay? .....	220
SYSTem:ERRor[:NEXT]? .....	220
SYSTem:LAbel .....	221
SYSTem:LAbel? .....	221
SYSTem:LFRequency? .....	221
SYSTem:OUTPut:EOF .....	221

SYSTem:OUTPut:EOF? .....	221
SYSTem:OUTPut:SEParate .....	221
SYSTem:OUTPut:SEParate? .....	221
SYSTem:PARAmeter:LOAD .....	221
SYSTem:PARAmeter:LOAD? .....	222
SYSTem:PARAmeter:SAVE .....	222
SYSTem:PRESet .....	222
SYSTem:SERial? .....	222
SYSTem:TEMPerature? .....	222
SYSTem:TIME .....	222
SYSTem:TIME? .....	222
SYSTem:UPTime? .....	222
SYSTem:VERsion? .....	222
SYSTem:WMESsage .....	223
SYSTem:WMESsage? .....	223

## SYSTem COMMunication Commands

SYSTem:COMMunicate:GPIB:ADDRes .....	223
SYSTem:COMMunicate:GPIB:ADDRes? .....	223
SYSTem:COMMunicate:LAN:DHCP .....	223
SYSTem:COMMunicate:LAN:DHCP? .....	223
SYSTem:COMMunicate:LAN:DNS[X] .....	223
SYSTem:COMMunicate:LAN:DNS[X]? .....	223
SYSTem:COMMunicate:LAN:GATeway .....	224
SYSTem:COMMunicate:LAN:GATeway? .....	224
SYSTem:COMMunicate:LAN:HOSTname .....	224
SYSTem:COMMunicate:LAN:HOSTname? .....	224
SYSTem:COMMunicate:LAN:IPADdress .....	224
SYSTem:COMMunicate:LAN:IPADdress? .....	224
SYSTem:COMMunicate:LAN:MAC? .....	224
SYSTem:COMMunicate:LAN:SMASK .....	224
SYSTem:COMMunicate:LAN:SMASK? .....	224
SYSTem:COMMunicate:LAN:TELNet:ECHO .....	225
SYSTem:COMMunicate:LAN:TELNet:ECHO? .....	225
SYSTem:COMMunicate:LAN:TELNet:ENABLE .....	225
SYSTem:COMMunicate:LAN:TELNet:ENABLE? .....	225
SYSTem:COMMunicate:LAN:TELNet:PORT .....	225

SYSTem:COMMunicate:LAN:TELNet:PORT? .....	225
SYSTem:COMMunicate:LAN:TELNet:PROMpt.....	225
SYSTem:COMMunicate:LAN:TELNet:PROMpt? .....	225
SYSTem:COMMunicate:LAN:TELNet:TIMeout .....	225
SYSTem:COMMunicate:LAN:TELNet:TIMeout?.....	226
SYSTem:COMMunicate:LAN:TELNet:WMESsage .....	226
SYSTem:COMMunicate:LAN:TELNet:WMESsage? .....	226
SYSTem:COMMunicate:LAN:TCP:ENABle .....	226
SYSTem:COMMunicate:LAN:TCP:ENABle? .....	226
SYSTem:COMMunicate:LAN:TCP:PORT .....	226
SYSTem:COMMunicate:LAN:TCP:PORT? .....	226
SYSTem:COMMunicate:LAN:TIMeout .....	226
SYSTem:COMMunicate:LAN:TIMeout? .....	226
SYSTem:COMMunicate:LAN:WEB:ENABle .....	227
SYSTem:COMMunicate:LAN:WEB:ENABle? .....	227

## Interface Commands

SYSTem:LOCAl .....	228
SYSTem:REMote .....	228
SYSTem:RWLock.....	228

## STATus Report Commands

STATus:OPERation:CONDition? .....	228
STATus:OPERation:ENABle .....	228
STATus:OPERation:ENABle? .....	228
STATus:OPERation[:EVENT]?.....	229
STATus:PRESet .....	229
STATus:QUEStionable:CONDition? .....	229
STATus:QUEStionable:ENABle .....	229
STATus:QUEStionable:ENABle? .....	229
STATus:QUEStionable[:EVENT]?.....	230

## IEEE 488.2 Common Commands

*CLS.....	230
*ESE?.....	230
*ESE.....	230
*ESR? .....	230
*IDN? .....	231
*OPC?.....	231
*OPC .....	231
*OPT?.....	231
*PSC .....	231
*PSC? .....	232
*RCL .....	232
*RST .....	232
*SAV .....	232
*SRE? .....	232
*SRE .....	232
*STB? .....	233
*TRG.....	233
*WAI.....	233

### Speed & NPLC & Resolution Relation Table

Speed	5/s	20/s	60(50)/s	100/s	400/s	1.2 k/s	2.4 k/s	4.8 k/s	7.2 k/s	10 k/s
NPLC(16.6ms)	12	3	1	0.6	0.15	0.05	0.025	0.0125	0.0083	0.006
Resolution(Range * PPM)										
Range\PPM	1	2	3	10	20	50	100	200	400	500
20	1.0E-05	2.0E-05	3.0E-05	1.0E-04	2.0E-04	5.0E-04	1.0E-03	2.0E-03	4.0E-03	5.0E-03
200	1.0E-04	2.0E-04	3.0E-04	1.0E-03	2.0E-03	5.0E-03	1.0E-02	2.0E-02	4.0E-02	5.0E-02
2k	1.0E-03	2.0E-03	3.0E-03	1.0E-02	2.0E-02	5.0E-02	1.0E-01	2.0E-01	4.0E-01	5.0E-01
 Note      The above contents of table are only references to NPLC and Resolution metioned within SCPI commands.										

## Other Commands

---

### ABORt

Aborts a measurement in progress, returning the instrument to the trigger idle state.

- Use this to abort a measurement when the instrument is waiting for a trigger, or for aborting a long measurement or series of measurements.
- 

### FETCh?

Waits for measurements to complete and copies all available measurements to the instrument's output buffer. The readings remain in reading memory.

Example: SAMP:COUN 3

INIT

FETC?

Returns: -4.98748741E-01,-4.35163427E-01,-4.33118686E-01

- The FETCh? query does not erase measurements from the reading memory. You can send the query multiple times to retrieve the same data.
  - You can store up to 100,000 measurements on the GVM-9102. If reading memory overflows, new measurements overwrite the oldest measurements stored; the most recent measurements are always preserved. No error is generated, but the Reading Mem Ovfl bit (bit 14) is set in the Questionable Data Register's condition register.
- 

### HCOPY:SDUMp:DATA?

Executes TFT LCD screenshot action.

Returns the front panel display image ("screen shot").

Returns a count of data streaming by the image file format of BMP.

---



**INITiate[:IMMediate]**

Changes the state of the triggering system from "idle" to "wait-for-trigger", and clears the previous set of measurements from reading memory.

Measurements begin when the specified trigger conditions are satisfied following the receipt of INIT.

Example: CONF:VOLT:DC 10

SAMP:COUN 5

TRIG:SOUR BUS

INIT

\*TRG

FETC?

- Storing measurements in reading memory with INITiate is faster than sending measurements to the instrument's output buffer using READ? (provided you do not send FETCh? until done). The INITiate command is also an "overlapped" command. This means that after executing INITiate, you can send other commands that do not affect the measurements.

- To retrieve the measurements from the reading memory, use FETCh?. Use DATA:REMOve? or R? to read and erase all or part of the available measurements.

- Use ABORt to return to idle.

---

**R? [<reading\_number>]**

Reads and erases measurements from reading memory up to the specified <reading\_number>.

The measurements are read and erased from the reading memory starting with the oldest measurement first.

Ex: SAMP:COUN 5

INIT

R? 4

Returns:

#263-1.12816521E-04,-1.13148354E-04,-1.13485152E-04,-1.13365632E-04

“#2” represents the length of readback data is 2 digits.

“63” represents the total length of readback data.

● If you do not specify a value for <reading\_number>, all measurements are read and erased.

Ex: SAMP:COUN 2

INIT

R?

Returns: #231-1.12816521E-04,-1.13148354E-04

● The R? and DATA:REMOVe? queries can be used during a long series of readings to periodically remove readings from memory that would normally cause the reading memory to overflow. R? does not wait for all readings to complete. It sends the readings that are complete at the time the instrument receives the command.

● Use Read? or Fetch? if you want the instrument to wait until all readings are complete before sending readings.

● No error is generated if the reading memory contains less readings than requested. In this case, all available readings in memory are read and deleted.

**READ?**

Returns 1<sup>st</sup> display value.

Return parameter: <NRf>, Ex: -1.13148354E-04

● The Read query will not return the unit or count number of the reading.

● Sending READ? is similar to sending INITi te followed immediately by FETCh?

**VAL1?**

Returns the 1<sup>st</sup> display value.

Example: SAMP:COUN 5

VAL1?

>+0.33452387E-4

>+0.32897125E -4

> etc, for 5 counts.

Queries 5 counts of stored samples from the 1<sup>st</sup> display.

---

**TIME:SYNC:SERVer**

Sets the server source for time sync of the 2nd group.

Parameter: "<server>", max length = 22 characters.

Example: TIME:SYNC:SERV "time-nv.nist.gov"

---

**TIME:SYNC:SERVer?**

Returns the server source for time sync of the 2nd group.

Return parameter: "<server>", Ex: "time-nv.nist.gov"

---

---

**CALCulate Commands**

---

**CALCulate:CLEar[:IMMEDIATE]**

Clears all of the compare results, statistic calculation value, histogram calculation value, and measurement value.

Parameter: <None>

Example: CALC:CLE:IMM

---

**CALCulate:DATA?**

Returns uncalculated original measurement.

---

**CALCulate:FUNction**

Sets the Advanced function.

Parameter: OFF | HOLD | DB | DBM | LIM | MXB | INV | REF

Example: CALC:FUNC DB

Sets the Advanced function to DB mode

---

**CALCulate:FUNction?**

Returns the current Advanced function.

Return parameter: OFF | HOLD | DB | DBM | LIM | MXB | INV | REF

---

**CALCulate:STATe**

Turns the Advanced function on/off.

Parameter: 0 | 1 | ON | OFF

Example: CALC:STAT OFF

Turns the Advanced function off.

---

**CALCulate:STATe?**

Returns the status of the Advanced function.

Return Parameter: 0 | 1, 1=ON, 0=OFF

---

**CALCulate:AVERage:ALL?**

Returns all of the statistic calculation values.

Return parameter: average, standard deviation, minimum, maximum values.

---

**CALCulate:AVERage:AVERage?**

Returns the average value.

Return parameter: <NRf>

---

**CALCulate:AVERage:CLEar[:IMMEDIATE]**

Clears all of the statistic calculation values.

Parameter: <None>

Example: CALC:AVER:CLE:IMM

---

**CALCulate:AVERage:COUNT?**

Returns the total count of statistic.

Return parameter: <NRf>

---

**CALCulate:AVERage:MAXimum?**

Returns the maximum value.

Return parameter: <NRf>

---

**CALCulate:AVERage:MINimum?**

Returns the minimum value.

Return parameter: <NRf>

---

**CALCulate:AVERage:PTPeak?**

Returns the peak to peak value (max value – min value).

Return parameter: <NRf>

---

**CALCulate:AVERage:SDEViation?**

Returns the Standard Deviation value.

Return parameter: <NRf>

---

**CALCulate:AVERage[:STATE]**

Turns the statistic calculation function on/off.

Parameter: 0 | 1 | ON | OFF

Example: CALC:AVER:STAT ON

Turns the statistic calculation function on.

---

**CALCulate:AVERage[:STATE]?**

Returns the statistic calculation function state.

Return parameter: 0 | 1, 1=ON, 0=OFF

---

**CALCulate:LIMit:CLEar[:IMMEDIATE]**

Clears compare function result counts

---

---

**CALCulate:LIMit:BEEPer:MODE**

Sets the beeper alarm mode of the compare function.

Parameter: OFF | PASS | FAIL

Example: CALC:LIM:BEEP:MODE:PASS

Sets the pass alarm to compare function.

---

**CALCulate:LIMit:BEEPer:MODE?**

Returns the beeper alarm mode of the compare function.

Return Parameter: OFF | PASS | FAIL

---

**CALCulate:LIMit:DATA?**

Returns the low / high fail count of the compare function.

Return Parameter: <NR1>

---

**CALCulate:LIMit:LOWer[:DATA]**

Sets the lower limit value of the compare function.

Parameter: <NRf> (-1.2E+08 ~ 1.2E+08) | MIN | MAX | DEF

Example: CALC:LIM:LOW:DATA -1.0

Sets the lower limit to -1.0

---

**CALCulate:LIMit:LOWer[:DATA]?**

Returns the lower limit value of the compare function.

Return parameter: <NRf>

---

**CALCulate:LIMit:UPPer[:DATA]**

Sets the upper limit value of the compare function.

Parameter: <NRf> (-1.2E+08 ~ 1.2E+08) | MIN | MAX | DEF

Example: CALC:LIM:UPP:DATA 1.0

Sets the upper limit to 1.0

---

**CALCulate:LIMit:UPPer[:DATA]?**

Returns the upper limit value of the compare function.

Return parameter: <NRf>

---

**CALCulate:LIMit[:STATE]**

Sets the status on/off for the compare function.

Parameter: 0 | 1 | ON | OFF

Example: CALC:LIM:STAT 1

Sets the compare function to on.

---

**CALCulate:LIMit[:STATE]?**

Returns the status of the compare function.

---

**CALCulate:MATH:MMFactor**

Sets the scale factor M for math measurement.

Parameter: <NRf> | MIN | MAX | DEF

Example: CALC:MATH:MMF MIN

Sets the scale factor M to the minimum allowed value.

---

**CALCulate:MATH:MMFactor?**

Returns the scale factor M used in the math measurement.

Return parameter: <NRf>

---

**CALCulate:MATH:MBFactor**

Sets the offset factor B for math measurement.

Parameter: <NRf> | MIN | MAX | DEF

Example: CALC:MATH:MBF MIN

Sets the offset factor B to the minimum allowed value.

---

**CALCulate:MATH:MBFactor?**

Returns the offset factor B used in the math measurement.

Return parameter: <NRf>

---

**CALCulate:TCHart[:STATe]**

Turns the trend chart function on/off.

Parameter: 0 | 1 | ON | OFF

Example: CALC:TCH:STAT ON

Turns the trend chart function on.

---

**CALCulate:TCHart [:STATe]?**

Returns the trend chart function state.

Return parameter: 0 | 1, 1=ON, 0=OFF

---

**CALCulate:TRANSform:HISTogram[:STATe]**

Turns the histogram function on/off.

Parameter: 0 | 1 | ON | OFF

Example: CALC:TRAN:HIST:STAT OFF

Turns the histogram function OFF.

---

**CALCulate:TRANSform:HISTogram[:STATe]?**

Returns the histogram function state.

Return parameter: 0 | 1, 1=ON, 0=OFF

---



**CALCulate:TRANSform:HISTogram:RANGe:AUTO**

Turns the auto setting on/off of the histogram's lower and upper range values.

Parameter: 0 | 1 | ON | OFF

Example: CALC:TRAN:HIST:RANG:AUTO OFF

Turns the auto setting off of the histogram's lower and upper range values.

---

**CALCulate:TRANSform:HISTogram:RANGe:AUTO?**

Returns the auto setting state of the histogram's lower and upper range values.

Return parameter: 0 | 1, 1=ON, 0=OFF.

---

**CALCulate:TRANSform:HISTogram:RANGe:LOWer**

Sets the lower range value of the histogram function.

Parameter: <NRf> (-1.0E+15 ~ 1.0E+15) | MIN | MAX | DEF

Example: CALC:TRAN:HIST:RANG:LOW -0.5

Sets the lower range value to -0.5.

---

**CALCulate:TRANSform:HISTogram:RANGe:LOWer?**

Returns the lower range value of the histogram function.

Return parameter: <NRf>

---

**CALCulate:TRANSform:HISTogram:RANGe:UPPer**

Sets the upper range value of the histogram function.

Parameter: <NRf> (-1.0E+15 ~ 1.0E+15) | MIN | MAX | DEF

Example: CALC:TRAN:HIST:RANG:UPP 1.0

Sets the upper range value to 1.0.

---

**CALCulate:TRANSform:HISTogram:RANGe:UPPer?**

Returns the upper range value of the histogram function.

Return parameter: <NRf>

---

**CALCulate:TRANSform:HISTogram[:STATE]**

Turns the histogram function on/off.

Parameter: 0 | 1 | ON | OFF

Example: CALC:TRAN:HIST:STAT OFF

Turns the histogram function OFF.

---

**CALCulate:TRANSform:HISTogram[:STATE]?**

Returns the histogram function state.

Return parameter: 0 | 1, 1=ON, 0=OFF

---



## CONFigure Commands

---

### CONFigure?

Return current function, range and resolution.

Example: CONF:VOLT:DC 10,MIN

CONF?

Rereuns: "VOLT +1.00000000E+01,+1.00000000E-05".

---

### CONFigure[:VOLTage]:DC

Sets measurement to DC Voltage on the 1<sup>st</sup> display and specifies range/resolution.

Parameter: [None] | [Range(<NRf> | AUTO | MIN | MAX | DEF)[,Resolution(<NRf> | MIN | MAX | DEF)]]

Example: CONF:VOLT:DC 1,MAX

Sets the voltage range to 1V and the resolution to the maximum.

- Autoranging (AUTO or DEFault), will generate an error if you specify a <resolution> because the instrument cannot accurately resolve the integration time (especially if the input continuously changes). If your application requires autoranging, specify DEFault for the <resolution> or omit the <resolution> altogether.

---

## DATA Commands

---

### DATA:LAST?

Returns the last measurement value with units taken. You can execute this query at any time, even during a series of measurements.

Return parameter: <NRf>, Ex: +0.15900000E+01 VDC

- If no data is available, +9.91000000E+37 (Not a Number) is returned with units

---

### DATA:POINts?

Returns the total number of measurements currently in reading memory.

Return parameter: <NR1>, Ex: +100

- You can store up to 100,000 measurements values on the GVM-9102.

---

### DATA:POINts:EVENT:THReshold

Sets the threshold for event number of measurement.

Parameter: <NR1> GVM-9102 : 1- 100,000

Example: DATA:POIN:EVENT:THR 10

Sets the event threshold to 10.

- When measurement numbers reach the set threshold, the Bit9 within the Operater Event Register (STATUS:OPERation:EVENT.) will be set as 1.
- Once the Memory Threshold bit (bit 9 in the Standard Operation Event register) is set, it remains set until cleared by STATUS:OPERation:EVENT? or \*CLS.

---

---

**DATA:POINTs:EVENT:THReshold?**

Returns the event threshold number.

Return parameter: <NR1>, Ex: +10

---

**DATA:REMOve? <reading\_number>,[WAIT]**

Reads and erases measurement values from reading memory up to the specified <reading\_number>.

The measurement values are read and erased from the reading memory starting with the oldest measurement first.

Ex:SAMP:COUN 10

INIT

DATA :REM? 4

Returns:

-1.12816521E-04,-1.13148354E-04,-1.13485152E-04,-1.13365632E-04

●If you do not specify a value for <reading\_number>, +9.91000000E+37 (Not a Number) is returned.

●If reading\_number is greater than the latest counts of measurement, it will return the error. However, it will return data if reading\_number of counts of measurement reach the set threshold only when WAIT parameter is specified.

●The R? and DATA:REMOve? queries can be used during a long series of readings to periodically remove readings from memory that would normally cause the reading memory to overflow. R? does not wait for all readings to complete. It sends the readings that are complete at the time the instrument receives the command.

---

## DIGital INTerface Commands

---

**DIGital:INTerface:MODE**

Sets the application mode of digital I/O (Remote Control Only). For details, refer to page 54.

Parameter: COMP | 4094 | IO

Example: DIG:INT:MDOE IO

Sets the digital I/O to IO mode.

---

**DIGital:INTerface:MODE?**

Returns the digital I/O mode.

Return parameter: COMP | 4094 | IO

---

**DIGital:INTerface:DATA:OUTPut**

When the 4094 mode (serial to parallel) is selected for digital I/O, make use of this command to set output status.

Parameter: <NR1> (0-255), <Boolean> (0 | 1) / (serial input data, strobe pulse)

Example: DIG:INT:MDOE 4094

DIG:INT:DATA:OUPT 10,1

---

---

**DIGital:INTErface:DATA:SETup**

When the IO mode is selected for digital I/O, make use of this command to set output status.

Parameter: <Boolean> (0 | 1) / (OUT1, OUT2, OUT3, OUT4)

Example: DIG:INT:MDOE IO

DIG:INT:DATA:SET 0,1,0,1

Sets OUT1 to low, OUT2 to high, OUT3 to low, OUT4 to high,

---

---

**DISPlay Commands**

---

**DISPlay[:STATe]**

Sets TFT LCD display screen on/off.

Parameter: 0 | 1 | ON | OFF

Example: DISP OFF

Turns the TFT LCD display screen OFF.

---

**DISPlay[:STATe]?**

Returns the TFT LCD display screen state.

Return parameter: 0 | 1, 0=OFF, 1=ON

---

**DISPlay:TEXT:CLEAr**

Clears the text message from the display.

- With DISP:STAT ON, DISP:TEXT:CLE returns the display to its normal mode.

- With DISP:STAT OFF, DISP:TEXT:CLE clears the message and the display remains disabled. To enable

the display, send DISPlay ON or press the front panel Shift key(Local).

---

**DISPlay:TEXT[:DATA]**

Sets the text message to TFTLCD display screen.

Parameter: "<message>"

Example: DISP:TEXT:DATA "testing"

Prints the testing characters to TFT LCD display screen.

---

**DISPlay:TEXT[:DATA]?**

Returns the text message of TFT LCD display screen.

Return parameter: "<message>", Ex: "testing"

---

**DISPlay:VIEW**

Sets the display form of measured value.

Parameter: NUMeric | HISTogram | TCHart | METer

Example: DISP:VIEW HIST

Sets display in the histogram mode.

---

**DISPlay:VIEW?**

Returns the display form of measured value.

Return parameter: NUM | HIST | TCH | MET

---

## MEASure Commands

---

### MEASure[:VOLTage]:DC?

Returns the DC voltage measurement value on the 1<sup>st</sup> display.

Parameter: [None] | [Range(<NRf> | AUTO | MIN | MAX | DEF)][,Resolution(<NRf> | MIN | MAX | DEF)]

Example: MEAS:VOLT:DC? MIN

> +6.64925206E-04

Returns the DC voltage measurement value as 0.6649 mV.

- Autoranging (AUTO or DEFault), will generate an error if you specify a <resolution> because the instrument cannot accurately resolve the integration time (especially if the input continuously changes). If your application requires autoranging, specify DEFault for the <resolution> or omit the <resolution> altogether.

## SENSE Related Commands

---

### [SENSE:]FUNCTION

Sets the function for the 1<sup>st</sup> display, Parameter:

(1<sup>st</sup>): "VOLT[:DC]",

Example: SENS:FUNC "VOLT:DC"

Sets the 1<sup>st</sup> display to the DCV function.

---

### [SENSE:]FUNCTION?

Returns the function displayed on the 1<sup>st</sup> display, Return parameter:

(1<sup>st</sup>): "VOLT"

---

### [SENSE:]DATA?

Returns the auxiliary measurement value.

---

### [SENSE:]DIGital:SHIFt

Sets the digital shift function on or off.

Parameter: 0 | 1 | ON | OFF

Example: SENS:DIG:SHIF ON

Turn the digital shift function on.

---

### [SENSE:]DIGital:SHIFt?

Returns the digital shift function status.

Return parameter: 0 | 1, 1=AUTO, 0=User selected

---

## SENSe AVERage Commands

---

### [SENSe:]AVERage:COUNT

Sets the digital filter count.

Parameter: <NR1> (2 ~ 100) | MIN | MAX | DEF

Example: SENS:AVER:COUNT 100

Sets 1<sup>st</sup> display digital filter count number to 100.

---

### [SENSe:]AVERage:COUNT?

Returns the digital filter count.

Return parameter: <NR1>, Ex: +002

---

### [SENSe:]AVERage:STATE

Turns the digital filter function On/Off.

Parameter: 0 | 1 | ON | OFF

Example: SENS:AVER:STAT ON

Turns 1<sup>st</sup> display digital filter function on.

●If NPLC  $\geq$  7.2k/s, the filter function will be disabled.

---

### [SENSe:]AVERage:STATE?

Returns the state of the digital filter function (on or off).

Return parameter: 0 | 1, 0=OFF, 1=ON

---

### [SENSe:]AVERage:TCONtrol

Selects the digital filter type.

Parameter: MOV | REP

Example: SENS:AVER:TCON MOV

Sets 1<sup>st</sup> display digital filter type to the moving filter.

---

### [SENSe:]AVERage:TCONtrol?

Returns the digital filter type.

Return parameter: MOV (moving) | REP (repeating)

---

### [SENSe:]AVERage:WINDow

Selects a digital filter window.

Parameters: 0.01 | 0.1 | 1 | 10 | NONE

Example: SENS:AVER:WIND 0.1

Sets 1<sup>st</sup> display digital filter window to 0.1%

---

### [SENSe:]AVERage:WINDow?

Returns the digital filter window value.

Return parameter: 0.01 | 0.1 | 1 | 10 | NONE

---

**[SENSe:]AVERAge:WINDow:METHod**

Selects a digital filter window method type.

Parameters: Measure | Range

Example: SENS:AVER:WIND:METH Measure

Sets 1<sup>st</sup> display digital filter window method to the measure type

---

**[SENSe:]AVERAge:WINDow:METHod?**

Returns the digital filter window method type.

Return parameter: Measure | Range

---

## SENSe VOLTage Commands

---

**[SENSe:]VOLTage[:DC]:NPLCycles**

Sets the integration time for DC Voltage measurement in PLCs (power line cycles). Where one PLC is equal to 16.6 milliseconds. For any <NRf> parameter, the GVM will automatically set the PLC to the closest acceptable PLC value (0.006 | 0.0083 | 0.0125 | 0.025 | 0.05 | 0.15 | 0.6 | 1 | 3 | 12).

Parameter: NPLCycles(<NRf> | MIN | MAX | DEF)

Example: SENS:VOLT:DC:NPLC 12

Sets the integration time to 12 PLCs for DC Voltage measurements.

---

**[SENSe:]VOLTage[:DC]:NPLCycles?**

Returns the integration time for DC Voltage measurement in PLCs (power line cycles). Where one PLC is equal to 16.6 milliseconds.

Return parameter: 0.006 | 0.0083 | 0.0125 | 0.025 | 0.05 | 0.15 | 0.6 | 1 | 3 | 12

---

**[SENSe:]VOLTage[:DC]:NULL[:STATe]**

Sets the relative function on/off for DC Voltage measurement.

Parameter: 0 | 1 | ON | OFF

Example: SENS:VOLT:DC:NULL:STAT OFF

Turns the relative function off for DC Voltage measurement.

---

**[SENSe:]VOLTage[:DC]:NULL[:STATe]?**

Returns the relative function state of DC Voltage measurement.

Return parameter: 0 | 1, 0=OFF, 1=ON

---

**[SENSe:]VOLTage[:DC]:NULL:VALue**

Sets the relative value for DC Voltage measurement.

Parameter: <NRf> (-1200.0~1200.0 V) | MIN | MAX | DEF

Example: SENS:VOLT:DC:NULL:STAT ON

SENS:VOLT:DC:NULL:VAL 1.2

Sets the relative value to 1.2V for DC Voltage measurement.

---

**[SENSe:]VOLTage[:DC]:NULL:VALue?**

Returns the current relative value of DC Voltage measurement.

---

---

[SENSe:]VOLTage[:DC]:NULL:VALue:AUTO

Sets the relative value auto on/off for DC Voltage measurement.

Parameter: 0 | 1 | ON | OFF

Example: SENS:VOLT:DC:NULL:STAT ON

SENS:VOLT:DC:NULL:VAL:AUTO ON

READ ?

The unit automatically sets the 1st count of measurement as null value.

---

[SENSe:]VOLTage[:DC]:NULL:VALue:AUTO?

Returns the null value auto state of DC Voltage measurement.

---

[SENSe:]VOLTage[:DC]:RANGe

Sets the DC voltage measurement range.

Parameter: <NRf> | MIN | MAX | DEF

Example: SENS:VOLT:DC:RANG MIN

Set the DC voltage range to lowest range allowed.

---

[SENSe:]VOLTage[:DC]:RANGe?

Returns the DC voltage measurement range.

---

[SENSe:]VOLTage[:DC]:RANGe:AUTO

Sets the DC voltage Auto-range setting on, off or once only.

Parameter: 0 | 1 | ON | OFF | ONCE

Example: SENS:VOLT:DC:RANG:AUTO ON

Turns Auto-range on for DC voltage measurements.

---

[SENSe:]VOLTage[:DC]:RANGe:AUTO?

Returns the DC voltage Auto-range settings.

Return parameter: 0 | 1, 0=OFF, 1=ON

---

[SENSe:]VOLTage[:DC]:RESolution

Sets the DC Voltage measurement resolution. The resolution depends on the rate and range settings.

Parameter: Resolution(<NRf> | MIN | MAX | DEF)

Example: SENS:VOLT:DC:RES MAX

Sets the DC Voltage resolution to MAX.

---

[SENSe:]VOLTage[:DC]:RESolution?

Returns the DC Voltage resolution.

---

[SENSe:]VOLTage[:DC]:TRIGger:DELay

Sets the trigger delay that minimum step is microseconds of DC Voltage measurement.

Parameter: <NRf>(0 ~ 3600 s) | MIN | MAX | DEF

Example: SENS:VOLT:DC:TRIG:DEL MAX

Sets the trigger delay time to the maximum of DC Voltage measurement.

---

---

[SENSe:]VOLTage[:DC]:TRIGger:DELay?

Returns the trigger delay time in seconds of DC Voltage measurement.

Return parameter: <NRf>

---

[SENSe:]VOLTage[:DC]:ZERO:AUTO

Sets the auto zero mode to on, off or once of DC Voltage measurement.

Parameter: 0 | 1 | ON | OFF | ONCE

Example: SENS:VOLT:DC:ZERO:AUTO ONCE

Sets the auto zero to once.

---

[SENSe:]VOLTage[:DC]:ZERO:AUTO?

Returns the auto zero mode of DC Voltage measurement.

Return Parameter: 0 | 1, 1=ON, 0=OFF

---

## TRIGger Commands

---

SAMPle:COUNT

Sets the number of samples.

Parameter: <NRf>(1.0 ~ 1000000.0) | MIN | MAX | DEF

Example: TRIG:COUN 10

SAMP:COUN 10

INIT

FETC?

Will returns 100 measurment results.

Sets the number of samples to 10.

- The total measurement counts is trigger count multiplication sample count.

---

SAMPle:COUNT?

Returns the number of samples.

Return parameter: <NRf>

---

TRIGger:COUNT

Sets the number of trigger counts.

Parameter: <NRf>(1.0 ~ 1000000.0) | MIN | MAX | DEF

Example: TRIG:COUN 10

SAMP:COUN 10

READ?

Will returns 100 measurment results.

Sets the number of trigger counts to 10.

- The total measurement counts is trigger count multiplication sample count.

---

TRIGger:COUNT?

Returns the number of trigger counts.

Return parameter: <NRf>

---



**TRIGger:DELay**

Sets the trigger delay time that minimum step is microseconds in all of the function.

Parameter: <NRf> (0 ~ 3600 s) | MIN | MAX | DEF

Example: TRIG:DEL MAX

Sets the trigger delay time to the maximum.

---

**TRIGger:DELay?**

Returns the trigger delay time in seconds of current function.

Return parameter: <NRf>

---

**TRIGger:DELay:AUTO**

Sets the trigger delay time auto mode on/off in all of the function.

Parameter: 0 | 1 | ON | OFF

Example: TRIG:DEL:AUTO OFF

Turns trigger delay time auto mode off.

---

**TRIGger:DELay:AUTO?**

Returns the trigger delay time auto mode state.

Return parameter: 0 | 1, 1=ON, 0=OFF.

---

**TRIGger:SLOPe**

Selects whether the instrument uses the rising edge (POS) or the falling edge (NEG) of the trigger signal on the rear-panel Digital I/O connector when external trigger is selected;

Parameter: POSitive | NEGative

Example: TRIG:SLOP POS

Sets the trigger signal in rising edge (POS).

---

**TRIGger:SLOPe?**

Returns the method of external trigger.

Return parameter: POS | NEG

---

**TRIGger:SOURce**

Selects the trigger source.

Parameter: IMMEDIATE | EXTERNAL | BUS

Example: TRIG:SOUR EXT

Sets the trigger source as external trigger.

**IMMEDIATE:**

The trigger signal is always present. When you place the instrument in the "wait-for-trigger" state, the trigger is issued immediately.

Ex:SAMP:COUN 5

TRIG:SOUR IMM

READ?

Returns : 5 measurement values.

**EXTERNAL:**

The instrument accepts hardware triggers applied to the rear-panel Ext Trig input and takes the

specified number of measurements (SAMP:COUN), each time a TTL pulse specified by

TRIG:SLOP is received. If the instrument receives an external trigger before it is ready, it buffers one trigger.

Ex:SAMP:COUN 5

TRIG:SOUR EXT

TRIG :SLOP NEG

INIT

<wait external trigger in signal>

FETC ?

Returns : 5 measurement values.

**BUS:**

The instrument is triggered by \*TRG over the remote interface once the GVM is in the "wait-for-trigger" state.

Ex:SAMP:COUN 5

TRIG:SOUR EXT

TRIG :SLOP NEG

INIT

\*TRG

FETC ?

Returns : 5 measurement values.

- After selecting the trigger source, you must place the instrument in the "wait-for-trigger" state by sending INITiate or READ?. A trigger is not accepted from the selected trigger source until the instrument is in the "wait-for-trigger" state.
-

---

**TRIGger:SOURce?**

Returns current trigger source.

Return parameter: IMM | EXT | BUS

---

**OUTPut:TRIGger:SLOPe**

Sets the output signal method after each measurement.

Parameter: POSitive | NEGative

Example: OUTP:TRIG:SLOP POS

Sets the output signal as positive pulse after measurement.

---

**OUTPut:TRIGger:SLOPe?**

Returns the output signal method after measurement.

Return parameter: POS | NEG

---

## SYSTEM Related Commands

---

**SYSTem:BEEPer[:IMMEDIATE]**

Makes buzzer beep once.

Parameter: <None>

Example: SYST:BEEP:IMM

- This function is Not affected by the state of SYST:BEEP:STAT.
- 

**SYSTem:BEEPer:ERRor**

Sets the beeper to sound on an SCPI error.

Parameter: 0 | 1 | ON | OFF

Example: SYST:BEEP:ERR ON

Allows the beeper to sound when an SCPI error occurs.

---

**SYSTem:BEEPer:ERRor?**

Returns the beeper error mode.

Return parameter: 0 | 1, 0=OFF, 1=ON

---

**SYSTem:BEEPer:STATE**

Turns the buzzer on/off.

Parameter: 0 | 1 | ON | OFF

Example: SYST:BEEP:STAT OFF

Turns the buzzer off.

- The key sound of front panel is Not affected by the state.
  - The command of SYSTem:BEEPer is Not affected by the state.
- 

**SYSTem:BEEPer:STATE?**

Returns the buzzer state.

Return parameter: 0 | 1, 1=ON, 0=OFF.

---

**SYSTem:BEEPer:COMPare:VOLume**

Sets the beeper volume of Compare function.

Parameter: <NR1> (0 ~ 2)

0(small), 1(Medium) , 2(Large)

Example: SYST:BEEP:COMP:VOL 2

Sets the beeper volume to large of Compare function.

---

**SYSTem:BEEPer:COMPare:VOLume?**

Returns the beeper volume of Compare function.

Return parameter: SMALL | MEDIUM | LARGE

---

**SYSTem:CLICk:STATe**

Turns the key sound of front panel on/off.

Parameter: 0 | 1 | ON | OFF

Example: SYST:CLIC:STAT OFF

Turns key sound off.

---

**SYSTem:CLICk:STATe?**

Returns the key sound of front panel state.

Return Parameter: 0 | 1, 1=ON, 0=OFF.

---

**SYSTem:DATE**

Sets the date for the instrument's real-time clock.

Parameter: <NR1> (year, month, day)

Example: SYST:DATE 2018,03,19

Sets the date to 2018/3/19.

year: 2000~2099

month: 1~12

day: 1~31

---

**SYSTem:DATE?**

Returns system date.

Return parameter: <Date>, Ex: 2018,3,19

---

**SYSTem:DISPlay**

Turns the TFT LCD display on/off.

Parameter: 0 | 1 | ON | OFF

Example: SYST:DISP ON

Turns the TFT LCD display on.

---

**SYSTem:DISPlay?**

Returns the status of the TFT LCD display

Return parameter: 0 | 1, 0=OFF, 1=ON

---

**SYSTem:ERRor[:NEXT]?**

Returns the current system error, if any.

---

---

**SYSTem:LABel**

Places a message in a large font on the bottom half of the instrument's front panel display.

Parameter: "< message >", max length 40 characters

Example: SYST:LAB "GW INSTEK"

- To turn off the message, send the following to change the label to a null string. This also removes the label area from the screen: SYST:LAB ""
  - The parameters will not be saved.
- 

**SYSTem:LABel?**

Returns the display message.

Return parameter: "< message >"

---

**SYSTem:LFRequency?**

Returns the AC source line frequency.

Parameter: +50 | +60

---

**SYSTem:OUTPut:EOF**

Sets the EOL character (CR+LF, LF+CR, CR, LF).

Parameter: <NR1>(0~3) (0=CR+LF, 1=LF+CR, 2=CR, 3=LF)

Example: SYST:OUTP:EOF 0

Sets the EOL character as CR+LF.

- The parameters will not be saved.
- 

**SYSTem:OUTPut:EOF?**

Returns the EOL character.

Return parameter: +0 | +1 | +2 | +3 (0=CR+LF, 1=LF+CR, 3=CR, 4=LF)

---

**SYSTem:OUTPut:SEParate**

Sets the command separation character.

Parameter: 0 | 1 (0=EOL, 1=,)

Example: SYST:OUTP:SEP 0

Sets the command separation character as the EOL character.

- The parameters will not be saved.
- 

**SYSTem:OUTPut:SEParate?**

Returns the command separation character.

Return parameter: 0 | 1 (0=EOL, 1=,)

---

**SYSTem:PARAmeter:LOAD**

Load the system parameters from 0 of 5 memory locations.

Parameter: <NR1> (0~5) (0=Default settings, 1~5= memory number)

Example: SYST:PAR:LOAD 0

Loads the default system parameters.

---

**SYSTem:PARAmeter:LOAD?**

Returns the loaded system parameters.

Return parameter: <NR1> (0~5) (0=Default settings, 1~5= memory number, Last = State before power-off)

---

**SYSTem:PARAmeter:SAVE**

Saves the system parameters into 1 of 5 memory slots.

Parameter: <NR1> (1~5)

Example: SYST:PAR:SAVE 1

Saves the system parameters to memory 1.

---

**SYSTem:PRESet**

This command is nearly identical to \*RST. The difference is that \*RST resets the instrument for SCPI operation, and SYSTem:PRESet resets the instrument for front panel operation. As a result, \*RST turns the histogram and statistics off, and SYSTem:PRESet turns them on.

---

**SYSTem:SERial?**

Returns the serial number (nine characters/numbers)

---

**SYSTem:TEMPerature?**

Returns the internal temperature of machine.

Return parameter: <NRf>, where unit = °C

---

**SYSTem:TIME**

Sets the time for the instrument's real-time clock.

Parameter: <NR1> (hour, minute, second)

Example: SYST:TIME 16,20,30

Sets the time to 16:20:30

hour: 0~23

minute: 0~60

second: 0~60

---

**SYSTem:TIME?**

Returns system time.

Return parameter: <Time>, Ex: 16:20:40.000

---

**SYSTem:UPTime?**

Returns the amount of time that the instrument has been running since the last power-on.

Return parameter: +0, +1, +25, +53 (day, hour, minute, second)

---

**SYSTem:VERSion?**

Returns SCPI version.

Return parameter: 1994.0.

---

**SYSTem:WMESsage**

Displays a power-on message.

Parameter: "<string>", max length 40 characters

Example: SYST:WMES "GW INSTEK"

● Specifying a null string ("") disables the power-on message.

---

**SYSTem:WMESsage?**

Returns the display string that is showing after power on.

Return parameter: "<string>"

---

## SYSTEM COMMunication Commands

---

**SYSTem:COMMunicate:GPIB:ADDRess**

Sets the GPIB address that is only on GPIB communication bus.

Parameter: <NR1> (0 ~ 30) | MIN | MAX | DEF

Example: SYST:COMM:GPIB:ADDR 15

Sets the GPIB address to 15.

---

**SYSTem:COMMunicate:GPIB:ADDRess?**

Returns the GPIB address.

Return parameter: <NR1> (0~30)

---

**SYSTem:COMMunicate:LAN:DHCP**

Sets the DHCP on/off.

Parameter: 0 | 1 | ON | OFF

Example: SYST:COMM:LAN:DHCP ON

Sets the DHCP on to automaticall get related configuration information.

---

**SYSTem:COMMunicate:LAN:DHCP?**

Returns the DHCP state.

Return parameter: 0 | 1, 0=OFF, 1=ON

---

**SYSTem:COMMunicate:LAN:DNS[X]**

Sets the DNS address. which X = 1 indicate DNS1, X = 2 indicate DNS2.

Parameter: "<address>"

Example: SYST:COMM:LAN:DNS1 "172.16.1.252"

Sets the DNS1 address to 172.16.1.252.

---

**SYSTem:COMMunicate:LAN:DNS[X]?**

Returns the DNS address. which X = 1 indicate DNS1, X = 2 indicate DNS2.

Return parameter: xxx.xxx.xxx.xxx

---

**SYSTem:COMMunicate:LAN:GATeway**

Sets the Gateway address.

Parameter: "<address>"

Example: SYST:COMM:LAN:GAT "192.168.31.254"

Sets the Gateway address to 192.168.31.254.

---

**SYSTem:COMMunicate:LAN:GATeway?**

Returns the Gateway address.

Return parameter: xxx.xxx.xxx.xxx

---

**SYSTem:COMMunicate:LAN:HOSTname**

Sets the hostname.

Parameter: "<string>", max length = 15 characters

Example: SYST:COMM:LAN:HOST "GVM"

Sets the Hostname to GVM.

---

**SYSTem:COMMunicate:LAN:HOSTname?**

Returns the hostname.

Return parameter: "<string>"

---

**SYSTem:COMMunicate:LAN:IPADdress**

Sets the IP address.

Parameter: "<address>"

Example: SYST:COMM:LAN:IPAD "192.168.31.117"

Sets the IP address to 192.168.31.117.

---

**SYSTem:COMMunicate:LAN:IPADdress?**

Returns the IP address.

Return parameter: xxx.xxx.xxx.xxx

---

**SYSTem:COMMunicate:LAN:MAC?**

Returns the MAC number.

Return parameter: 12 Hexadecimal characters.

---

**SYSTem:COMMunicate:LAN:SMASK**

Sets the subnet mask address.

Parameter: "<address>"

Example: SYST:COMM:LAN:SMAS "255.255.255.0"

Sets the subnet mask address to 255.255.255.0.

---

**SYSTem:COMMunicate:LAN:SMASK?**

Returns the subnet mask address.

Return parameter: xxx.xxx.xxx.xxx

---



---

SYSTem:COMMunicate:LAN:TELNet:ECHO

Sets the Telnet communication echo state.

Parameter: 0 | 1 | ON | OFF

Example: SYST:COMM:LAN:TELN:ECHO ON

Sets the Telnet communication echo to on.

---

SYSTem:COMMunicate:LAN:TELNet:ECHO?

Returns the Telnet communication echo state.

Return parameter: 0 | 1, 0=OFF, 1=ON

---

SYSTem:COMMunicate:LAN:TELNet:ENABLE

Sets the Telnet communication enable/disable.

Parameter: 0 | 1 | ON | OFF

Example: SYST:COMM:LAN:TELN:ENAB ON

Enables the Telnet communication.

---

SYSTem:COMMunicate:LAN:TELNet:ENABLE?

Returns the Telnet communication state.

Return parameter: 0 | 1, 0=OFF, 1=ON

---

SYSTem:COMMunicate:LAN:TELNet:PORT

Sets the Telnet communication port number.

Parameter: <NR1> (1024~65535) | MIN | MAX | DEF

Example: SYST:COMM:LAN:TELN:PORT "3000"

Sets the Telnet port to 3000.

---

SYSTem:COMMunicate:LAN:TELNet:PORT?

Returns the Telnet port number.

Retrurn parameter: <NR1>

---

SYSTem:COMMunicate:LAN:TELNet:PROMpt

Sets the telnet prompt message.

Parameter: "<string>", max length 15 characters

Example: SYST:COMM:LAN:TELN:PROM "GVM9102>"

Sets the telnet prompt characters to GVM9102>.

---

SYSTem:COMMunicate:LAN:TELNet:PROMpt?

Returns the telnet prompt message.

Retrurn parameter: "<string>"

---

SYSTem:COMMunicate:LAN:TELNet:TIMEout

Sets the timeout time for auto logout from Telnet communication, where unit of time is second.

Parameter: <NR1> (0~60000)

Example: SYST:COMM:LAN:TELN:TIM 0

Since 0 indicates infinite, Telnet communication has no timeout always.

---

---

**SYSTem:COMMunicate:LAN:TELNet:TIMEout?**

Returns the set time for timeout of Telnet communication.

Return parameter: <NR1>

---

**SYSTem:COMMunicate:LAN:TELNet:WMESsage**

Sets the telnet welcome message that telnet communication connect success.

Parameter: "<string>", max length 63 characters

Example: SYST:COMM:LAN:TELN:WMES "Welcome to GVM9102 Telnet Server"

Sets the telnet welcome message to Welcome to GVM9102 Telnet Server.

---

**SYSTem:COMMunicate:LAN:TELNet:WMESsage?**

Returns the telnet welcome message.

Return parameter: "<string>"

---

**SYSTem:COMMunicate:LAN:TCP:ENABLE**

Sets the TCP communication enable/disable.

Parameter: 0 | 1 | ON | OFF

Example: SYST:COMM:LAN:TCP:ENAB ON

Enables the TCP communication.

---

**SYSTem:COMMunicate:LAN:TCP:ENABLE?**

Returns the TCP communication state.

Return parameter: 0 | 1, 0=OFF, 1=ON

---

**SYSTem:COMMunicate:LAN:TCP:PORT**

Sets the TCP communication port number.

Parameter: <NR1> (1024~65535) | MIN | MAX | DEF

Example: SYST:COMM:LAN:TCP:PORT "3001"

Sets the TCP port to 3001.

---

**SYSTem:COMMunicate:LAN:TCP:PORT?**

Returns the TCP port number.

Return parameter: <NR1>

---

**SYSTem:COMMunicate:LAN:TIMEout**

Sets the TCP communication timeout time, where unit = second.

Parameter: <NR1> (1~60000)

Example: SYST:COMM:LAN:TIM 10

Makes the TCP communication timeout time to 10s.

---

**SYSTem:COMMunicate:LAN:TIMEout?**

Returns the TCP communication timeout time.

Return parameter: <NR1>

---

**SYSTem:COMMunicate:LAN:WEB:ENABle**

Sets the Web page communication enable/disable.

Parameter: 0 | 1 | ON | OFF

Example: SYST:COMM:LAN:WEB:ENAB ON

Enables the Web page communication.

---

**SYSTem:COMMunicate:LAN:WEB:ENABle?**

Returns the Web page communication state.

Return parameter: 0 | 1, 0=OFF, 1=ON

---

## Interface Commands

---

### SYSTem:LOCal

Enables local control (front panel control) and disables remote control.

---

### SYSTem:REMOte

Enables remote control and disables local control (front panel control, all key are disable except Shift key(return to local control)).

---

### SYSTem:RWLock

Enables remote control and disables local control (front panel control, all key are disable).

---

## STATUS Report Commands

---

### STATus:OPERation:CONDition?

Returns the total number of the Operation Condition register.

Return parameter: <NR1>, Ex: +4096

- A condition register continuously monitors the state of the instrument. Condition register bits are updated in real time; they are neither latched nor buffered.

This register is read-only; bits are not cleared when read.

---

### STATus:OPERation:ENABle

Sets bits in the Operation Enable register.

Parameter: <NR1> (0~32767)

Example: STAT:OPER:ENAB 10

Sets the bit1 and bit3 in Operation Enable register,  $10 = 2^1 + 2^3$ .

- The selected bits are then reported to the Status Byte. An enable register defines which bits in the event register will be reported to the Status Byte register group. You can write to or read from an enable register.

- A STATus:PRESet clears all bits in the enable register.

- The \*PSC command controls whether the enable register is cleared at power on.

---

### STATus:OPERation:ENABle?

Returns the total number of the Operation Enable register.

Return parameter: <NR1>, Ex: +256

---

---

**STATus:OPERation[:EVENT]?**

Returns the total number of the Operation Event register.

Return parameter: <NR1>, Ex: +786

- An event register is a read-only register that latches events from the condition register. While an event bit is set, subsequent events corresponding to that bit are ignored.
  - Once a bit is set, it remains set until cleared by reading the event register or by sending \*CLS (clear status).
- 

**STATus:PRESet**

Clears the Operation Enable register and Questionable Enable register.

Example: STAT:PRES

---

**STATus:QUEStionable:CONDition?**

Returns the contents of the Questionable Condition register.

Return parameter: <NR1>, Ex: +2

- A condition register continuously monitors the state of the instrument. Condition register bits are updated in real time; they are neither latched nor buffered.
  - This register is read-only; bits are not cleared when read.
- 

**STATus:QUEStionable:ENABLE**

Set bits in the Ouesrionable Enable register.

Parameter: <NR1> (0~32767)

Example: STAT:QUES:ENAB 4099

Sets the bit0, bit1 and bit12 in Ouesrionable Enable register,  $4099 = 2^0 + 2^1 + 2^{12}$ .

- The selected bits are then reported to the Status Byte. An enable register defines which bits in the event register will be reported to the Status Byte register group. You can write to or read from an enable register.
  - A STATus:PRESet clears all bits in the enable register.
  - The \*PSC command controls whether the enable register is cleared at power on.
- 

**STATus:QUEStionable:ENABLE?**

Returns the total number of the Ouesrionable Enable register.

Return parameter: <NR1>, Ex: +1

---

**STATUS:QUESTIONABLE[:EVENT]?**

Returns the total number of the Questionable Event register.

Return parameter: <NR1>, Ex: +2

- An event register is a read-only register that latches events from the condition register. While an event bit is set, subsequent events corresponding to that bit are ignored.
- Once a bit is set, it remains set until cleared by reading the event register or by sending \*CLS (clear status).

## IEEE 488.2 Common Commands

---

**\*CLS**

Clears the Event Status register (Output Queue, Operation Event Status, Questionable Event Status, Standard Event Status Register)

**\*ESE?**

Returns the ESER (Event Status Enable Register) contents.

Example: \*ESE?

>130

Returns 130. ESER=10000010

**\*ESE**

Sets the ESER contents.

Parameter: <NR1> (0~255)

Ex: \*ESE 65

Sets the ESER to 01000001

- The selected bits are then reported to bit 5 of the Status Byte Register. An enable register defines which bits in the event register will be reported to the Status Byte register group. You can write to Or read from an enable register.

**\*ESR?**

Returns SESR (Standard Event Status Register) contents.

Ex: \*ESR?

>198

Returns 198. SESR=11000110

- An event register is a read-only register that latches events from the condition register. While an event bit is set, subsequent events corresponding to that bit are ignored.
- Once a bit is set, it remains set until cleared by reading the event register or by sending \*CLS (clear status).

---

**\*IDN?**

Returns the manufacturer, model No., serial number and system version number.

Example: \*IDN?

>GWInstek,GVM9102,000000000,M0.70\_S0.25B

---

**\*OPC?**

Returns 1 to the output buffer after all pending commands complete. Other commands cannot be executed until this command completes.

Ex: CONF:VOLT:DC

SAMP:COUN 100

INIT

\*OPC?

●The difference between \*OPC and \*OPC? is that \*OPC sets a status bit when the operation completes, and \*OPC? outputs "1" when the operation completes.

---

**\*OPC**

Sets operation complete bit (bit0) in SESR (Standard Event Status Register) when all pending operations are completed.

Ex: \*CLS

\*ESE 1

\*SRE 32

CONF:VOLT:DC

SAMP:COUN 10

INIT

\*OPC

●The difference between \*OPC and \*OPC? is that \*OPC sets a status bit when the operation completes, and \*OPC? outputs "1" when the operation completes.

---

**\*OPT?**

Returns a string identifying any installed options.

---

**\*PSC**

Clears Power On status.

Parameter: <Boolean>(0|1) 0= disables, 1= enables

●Enables (1) or disables (0) the clearing of certain enable registers at power on:

Questionable Data Register (STATus:OPERation:ENABLE)

Standard Operation Register (STATus:QUESTionable:ENABLE)

Status Byte Condition Register (\*SRE)

Standard Event Enable Register (\*ESE)

●The \*PSC command does not affect the clearing of the condition or event registers, just the enable registers.

---

**\*PSC?**

Returns power on clear status.

Return parameter: <Boolean>(0|1) 0= disables, 1= enables

---

**\*RCL**

Load the system parameters from 1 of 5 memory locations.

Parameter: <NR1> (0~4) (1~5= memory number)

Example: \*RCL 1

Loads the memory 2 system parameters.

Note: prior to loading memory, the corresponding memory data is required; otherwise, invalid data will be loaded and therefore command error will be shown.

---

**\*RST**

Recalls default panel setup.

- Resets instrument to factory default state. This is similar to SYSTem:PRESet. The difference is that \*RST resets the instrument for SCPI operation, and SYSTem:PRESet resets the instrument for front panel operation. As a result, \*RST turns the histogram and statistics off, and SYSTem:PRESet turns them on.

---

**\*SAV**

Save the system parameters to 1 of 5 memory locations.

Parameter: <NR1> (0~4) (1~5= memory number)

Example: \*SAV 2

Saves the system parameters to memory 3.

---

**\*SRE?**

Returns the SRER (Service Request Enable Register) contents.

---

**\*SRE**

Sets SRER contents.

Parameter: <NR1>(0~255)

Example: \*SRE 7

Sets the SRER to 00000111.

- An enable register defines which bits in the event register will be reported to the Status Byte register group. You can write to or read from an enable register.

---



**\*STB?**

Returns the SBR (Status Byte Register) contents.

Example: \*STB?

>81

Returns the contents of the SBR as 01010001.

- A condition register continuously monitors the state of the instrument. Condition register bits are updated in real time; they are neither latched nor buffered.
  - This register is read-only; bits are not cleared when read.
- 

**\*TRG**

Manually triggers the GVM-9102 if TRIG:SOUR is selected to BUS.

Ex: SAMP:COUN 10

TRIG:SOUR BUS

INIT

\*TRG

FETC?

---

**\*WAI**

Configures the instrument's output buffer to wait for all pending operations to complete before executing any additional commands over the interface.

---

# Status system

The diagram below is a description of the status system

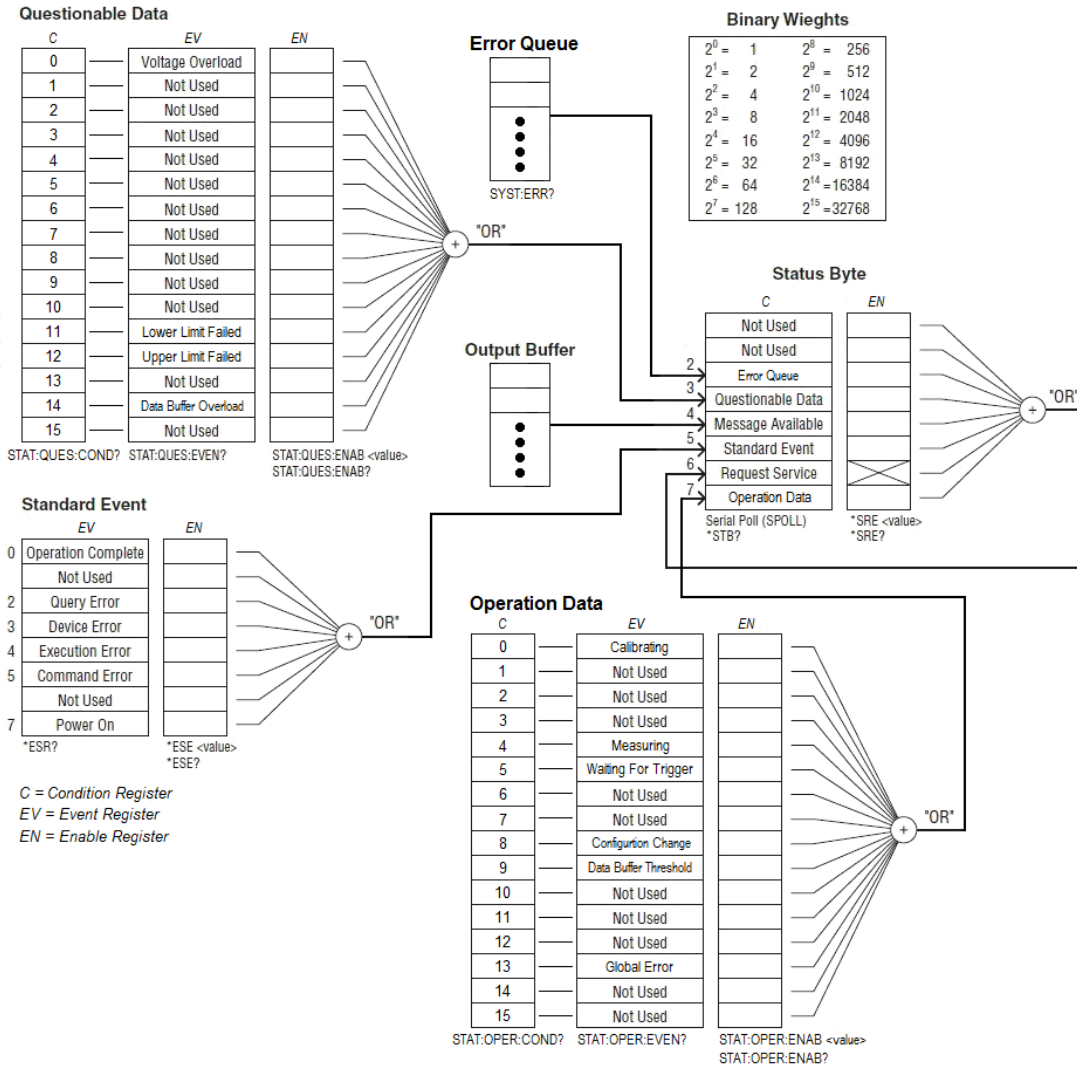

The following table lists the bit definitions for the Questionable Data Register:



**NOTE:** The overload bits are set once per INITiate command. If you clear an overload bit, it is not set again until a new INITiate is sent.

Bit	Name	Decimal	Definition
0	Voltage Overload	1	Only reported as event. In Conditon Register this bit always returns 0. Read the Event Register.
1	Not Used	2	(Reserved for future use)
2	Not Used	4	(Reserved for future use)
3	Not Used	8	(Reserved for future use)
4	Not Used	16	(Reserved for future use)
5	Not Used	32	(Reserved for future use)
6	Not Used	64	(Reserved for future use)
7	Not Used	128	(Reserved for future use)
8	Not Used	256	(Reserved for future use)
9	Not Used	512	(Reserved for future use)
10	Not Used	1024	(Reserved for future use)
11	Lower Limit Failed	2048	The most recent measurement failed the lower limit test.
12	Upper Limit Failed	4096	The most recent measurement failed the upper limit test.
13	Not Used	8192	(Reserved for future use)
14	Data Buffer Overload	16384	Data buffer is full. One or more (oldest) measurements have been lost.
15	Not Used	32768	(Reserved for future use)

The following table lists the bit definitions for the Operation Data Register:

Bit	Name	Decimal	Definition
0	Calibrating	1	Instrument is performing a calibration.
1	Not Used	2	(Reserved for future use)
2	Not Used	4	(Reserved for future use)
3	Not Used	8	(Reserved for future use)
4	Measuring	16	Instrument is initiated, and is making or about to make a measurement.
5	Waiting For Trigger	32	Instrument is waiting for a trigger.
6	Not Used	64	(Reserved for future use)
7	Not Used	128	(Reserved for future use)
8	Configuration Change	256	Instrument configuration has been changed since the last INIT, READ? or MEASURE?, either from the front panel or from SCPI.
9	Data Output Threshold	512	Programmed number of measurements (DATA:POINTS:EVENT:THRESHOLD) have been stored in measurement memory.
10	Not Used	1024	(Reserved for future use)
11	Not Used	2048	(Reserved for future use)
12	Not Used	4096	(Reserved for future use)
13	Global Error	8192	Set if any remote interface has an error in its error queue; cleared otherwise.
14	Not Used	16384	(Reserved for future use)
15	Not Used	32768	(Reserved for future use)

The following table describes the Standard Event Register

Bit	Name	Decimal	Definition
0	Operation Complete	1	All commands prior to and including *OPC have been executed.
1	Not Used	2	(Reserved for future use)
2	Query Error	4	The instrument tried to read the output buffer but it was empty. Or, a new command line was received before a previous query has been read. Or, both the input and output buffers are full.
3	Device Error	8	A device error, including a self-test error or calibration error, occurred (an error in the -300 range or any positive error has been generated).
4	Execution Error	16	An execution error occurred (an error in the -200 range has been generated).
5	Command Error	32	A command syntax error occurred (an error in the -100 range has been generated).
6	Not Used	64	(Reserved for future use)
7	Power On	128	Power has been cycled since the last time the event register was read or cleared.

The following table describes the Status Byte Register.

Bit	Name	Decimal	Definition
0	Not Used	1	(Reserved for future use)
1	Not Used	2	(Reserved for future use)
2	Error Queue	4	One or more errors have been stored in the Error Queue. Use SYST:ERR? to read and delete errors.
3	Questionable Data	8	One or more bits are set in the Questionable Data Register (bits must be enabled, see STAT:QUES:ENAB).
4	Message Available	16	Data is available in the instrument's output buffer.
5	Standard Event	32	One or more bits are set in the Standard Event Register (bits must be enabled, see *ESE).
6	Request Service	64	One or more bits are set in the Status Byte Register and may generate a Request for Service(RQS). Bits must be enabled using *SRE.
7	Operation Data	128	One or more bits are set in the Standard Operation Register (bits must be enabled, see STAT:OPER:ENAB).

# APPENDIX

---

<b>Fuse Replacement</b> .....	<b>239</b>
Replace AC Source Fuse.....	239
<b>Battery Replacement</b> .....	<b>240</b>
<b>Factory Default Parameters</b> .....	<b>242</b>
<b>Specifications</b> .....	<b>245</b>
General .....	245
<b>GVM-9102 Section</b> .....	<b>246</b>
Characteristics <sup>[1]</sup> .....	246
Dimensions .....	247
<b>Declaration of Conformity</b> .....	<b>248</b>

# Fuse Replacement

## Replace AC Source Fuse

**Steps** 1. Take off the power cord and place dual flat-blade drivers into the grooves of fuse socket sideways followed by pinch together to pull out the fuse socket.

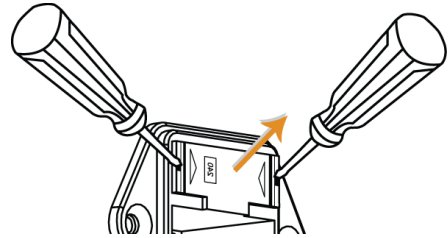

2. The fuse socket appears. The “240” symbol within the hole on fuse socket indicates the line voltage is positioned as 240 V.

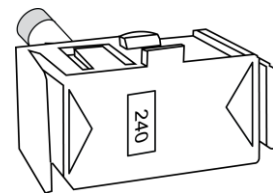

3. Pull the fuse holder out of the fuse socket gently as the right figure illustrates.

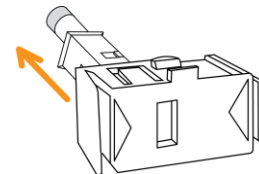

4. Further pull the fuse out of the fuse holder and replace it with a new fuse.

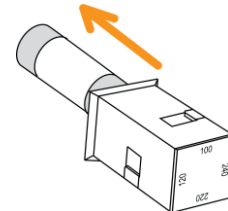

5. Restore the fuse holder with new fuse back to the fuse socket. Ensure the correct line voltage shows within the hole of the fuse socket per requirement.

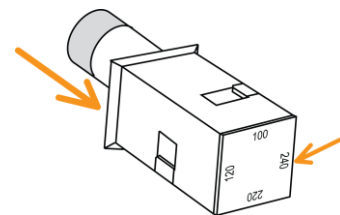

Rating	Type of fuse (time-lag)	Input line voltage
	T 0.25 A, 250 V, 5 x 20 mm	100/120 VAC
	T 0.125 A, 250 V, 5 x 20 mm	220/240 VAC

## Battery Replacement

---

- Beforehand** This chapter describes the procedure of battery replacement in the front panel. Before start, it is required to let a certified and trained technician properly aware of potential risks to disassemble instrument case. Unplug power cord and disconnect external circuit from the instrument before opening the case. Some of the electrical connections are dynamic and even available after powering off the instrument. Consequently, Do disconnect all the inputs, cords and cables before disassembling the instrument.
- The steps to replace battery**
1. Power off properly and disconnect all the test leads, cables including power cord.
  2. Disassemble the instrument case in light of the disassembling instructions.
  3. Find the battery (CR2032) on the main board, which is perfectly located in the BT101 behind the transformer.





- 
4. Gently remove the metal guard plate on top of the battery as the figure shown.





5. Use pliers to clamp the battery out off the compartment.



6. Remove the battery and dispose or recycle it in accord with the applicable regulations.
  7. Place the new battery (CR2032) into the compartment and beware of the polarity (+, -). “+” is way close to the metal guard plate. Gently press the battery downwards to make it firmly fixed.
  8. Connect every cable and cord in need and reassemble the instrument in proper order. The procedure of battery replacement is completed.
-

## Factory Default Parameters

<b>Measurement</b>			
<b>Item List</b>	<b>Factory Default Parameter</b>	<b>Parameter Save/Load for Group 1 - 5</b>	
1ST Function	DCV	✓	
1ST Range	Auto Range	✓	
1ST Speed	5/s	✓	
Filter	On	✓	
Filter Type	Move	✓	
Filter Count	10	✓	
Filter Windows	0.10%	✓	
Filter Method	Measure	✓	
Auto Zero	On	✓	
<b>Display</b>			
<b>Item List</b>	<b>Factory Default Parameter</b>	<b>Parameter Save/Load for Group 1 - 5</b>	
Digit	Auto	✓	
Display	Number	✓	
Bar Meter	Scale	✓	
	VScale	✓	
TrendChart	HScale	✓	
	Recent HScale	✓	
Histogram	Bins	✓	
	HScale	✓	
<b>Math</b>			
<b>Item List</b>	<b>Factory Default Parameter</b>	<b>Parameter Save/Load for Group 1 - 5</b>	

Math Function	Off	✓	
Math Display	Off	✓	
Rel	Function	Off	✓
Compare	Beep Mode	Off	✓
	Beep Volume	Medium	✓
	Low Limit	-1	✓
	High Limit	1	✓
MX+B	M Value	1	✓
	B Value	0	✓

<b>Trigger</b>	
----------------	---

Item List	Factory Default Parameter	Parameter Save/Load for Group 1 - 5
Trigger Source	Auto	✓
Trigger Delay	Auto	✓
Trigger Signal	NEG	✓
Sample Count	1	✓
EOM Out	NEG	✓

<b>Menu</b>
-------------

Item List	Factory Default Parameter	Parameter Save/Load for Group 1 - 5	
System	Beep	On	✓
	Key Sound	On	✓
	Internet Time Sync	Disable	✗
Display	Brightness	60 %	✓
	AutoOff	OFF	✓
	AutoOff Time	30 min	✓
	1ST Font Color	White	✓
	Math Font Color	White	✓
	Antialiasing	Off	✓
Additional Info	All On	✓	

	Languge	English	✗
Interface	Interface	RS232	✗
	BaudRate	115200	✗
	FlowCtrl	Off	✗
	EOL Character	CR+LF	✗
	Separation Character	Comma	✗
	USB Protocol	USBCDC	✗
	GPIB Address	15	✗
	Identity	Default	✗
	Lan	DHCP	ON
Web		ON	✗
Telnet		ON	✗
Telnet Port		3000	✗
Telnet Echo		ON	✗
TCP		ON	✗
TCP Port		3001	✗



Only utilized parameters are listed here due to over-amount parameters. The rest of the parameters unlisted, however, can be saved and loaded as well.



It indicates parameters can be saved and loaded from the groups 1 to 5.



It indicates the independent save zone which is free from impact of reboot.

# Specifications

## General

This section lists the general characteristics of the instrument.

	Note	<ul style="list-style-type: none"> <li>• All specifications are ensured only under a single display.</li> <li>• At least 1 hour of warm-up time is required before applying these specifications.</li> <li>• Make sure that the Input LO to earth is limited to 500 Vpk.</li> <li>• Max DC 2400 V</li> <li>• Measurement is rated for CAT 'none'.</li> </ul>
Line Power		<ul style="list-style-type: none"> <li>• Power Supply: AC 100 V / 120 V / 220 V / 240 V <math>\pm</math> 10 %</li> <li>• Power Line Frequency: 50 Hz / 60 Hz / 400 Hz <math>\pm</math> 10%</li> <li>• Power Consumption: Max. 25 VA</li> </ul>
Environment		<ul style="list-style-type: none"> <li>• Operating Environment: Full accuracy for 0 °C to 55 °C</li> <li>• &lt; 30 °C: &lt; 80 % RH (non-condensing)</li> <li>• 30 °C to 40 °C: &lt; 70 % RH (non-condensing)</li> <li>• &gt; 40 °C: &lt; 50 % RH (non-condensing)</li> <li>• Operating Altitude Up to 2,000 m</li> <li>• Storage Temperature -40 to 70 °C</li> </ul>
Mechanical		<ul style="list-style-type: none"> <li>• Rack Dimensions: 88 mm (H) X 220 mm (W) X 276.6 mm (D) (without bumpers)</li> <li>• Bench Dimensions: 107 mm (H) X 266.9 mm (W) X 301.8 mm (D) (with bumpers)</li> <li>• Weight : 3.53 kg (7.8 lbs)</li> </ul>
Display		<ul style="list-style-type: none"> <li>• 4.3" color TFT WQVGA (480x272) with LED backlight</li> <li>• Supports basic number, bar meter, trend chart and histogram views</li> </ul>
Temperature Coefficient		<ul style="list-style-type: none"> <li>• Increment of one coefficient per one degree celsius when the range is beyond TCAL <math>\pm</math> 5 °C.</li> </ul>
Accuracy Specification		<ul style="list-style-type: none"> <li>• It is relevant to the calibration standard. TCAL = 23 °C.</li> </ul>
Real-Time		<ul style="list-style-type: none"> <li>• Set and read, year, month, day, hour, minute, seconds</li> </ul>
Clock/Calendar		<ul style="list-style-type: none"> <li>• Battery CR-2032 coin-type, replaceable</li> </ul>

# GVM-9102 Section

## Characteristics [1]

### DC Voltage

Range [2]	1 Year TCAL ± 5 °C	Temperature Coefficient/°C
20.00000 V	0.0100 + 0.0040	0.0010 + 0.0010
200.0000 V	0.0100 + 0.0010	0.0010 + 0.0005
2000.000 V	0.0100 + 0.0010	0.0010 + 0.0005

Accuracy Specifications: ± ( % of reading + % of range )

## Measuring Characteristics

DC Voltage	Range	Input Resistance
	20 V	
	200 V	30 MΩ ± 1 %
	2000 V	
	Input Bias	30 pA (Typ, 25 °C)
	Input Protection	3000 V on all ranges

Measurement Method: Sigma-delta A/D Converter

	Speed	Digits
Reading Rate (Readings/sec)	5/s , 20/s , 60/s , 100/s	6 ½
	400/s , 1.2 k/s , 2.4 k/s	5 ½
	4.8 k/s , 7.5 k/s , 10 k/s	4 ¼

[1].DC Specification: In addition to the availability that requires warm-up of 60 minutes, it must be set in 5/s speed rate, A-Zero on.

[2].The entire range of measurement will pass the set range by 20 %.

**Dimensions**

---

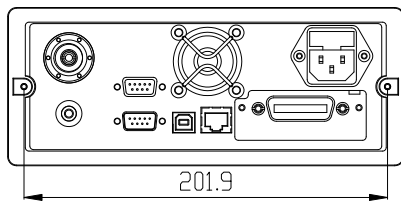
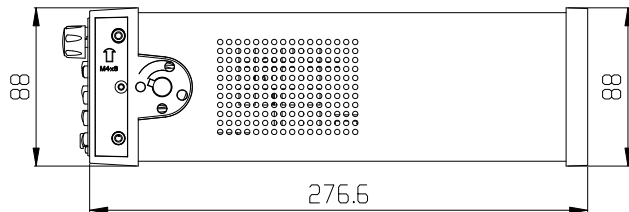
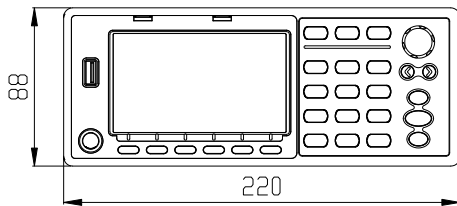
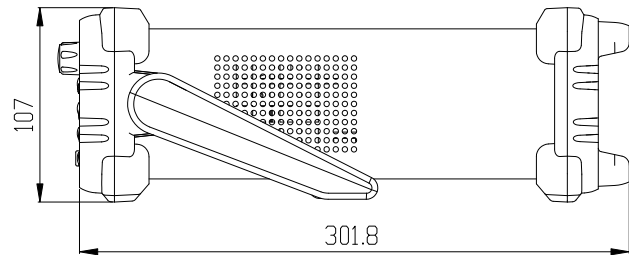
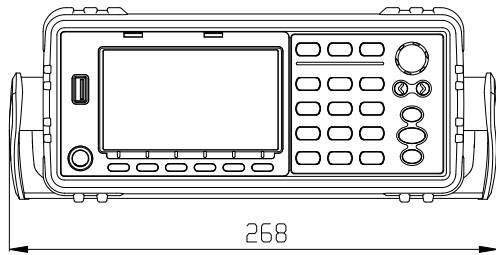

All dimensions are shown in millimeters.

## Declaration of Conformity

We

**GOOD WILL INSTRUMENT CO., LTD.**

declare that the CE marking mentioned product satisfies all the technical relations application to the product within the scope of council:

Directive: EMC; LVD; WEEE; RoHS

The product is in conformity with the following standards or other normative documents:

© EMC	
EN 61326-1 :	Electrical equipment for measurement, control and laboratory use — EMC requirements
Conducted & Radiated Emission EN 55011 / EN 55032	Electrical Fast Transients EN 61000-4-4
Current Harmonics EN 61000-3-2 / EN 61000-3-12	Surge Immunity EN 61000-4-5
Voltage Fluctuations EN 61000-3-3 / EN 61000-3-11	Conducted Susceptibility EN 61000-4-6
Electrostatic Discharge EN 61000-4-2	Power Frequency Magnetic Field EN 61000-4-8
Radiated Immunity EN 61000-4-3	Voltage Dip/ Interruption EN 61000-4-11 / EN 61000-4-34
© Safety	
EN 61010-1 :	Safety requirements for electrical equipment for measurement, control, and laboratory use - Part 1: General requirements

### GOODWILL INSTRUMENT CO., LTD.

No. 7-1, Jhongsing Road, Tucheng District, New Taipei City 236, Taiwan

Tel: [+886-2-2268-0389](tel:+886-2-2268-0389)

Fax: [+886-2-2268-0639](tel:+886-2-2268-0639)

Web: <https://www.gwinstek.com>

Email: [marketing@goodwill.com.tw](mailto:marketing@goodwill.com.tw)

### GOODWILL INSTRUMENT (SUZHOU) CO., LTD.

No. 521, Zhujiang Road, Snd, Suzhou Jiangsu 215011, China

Tel: [+86-512-6661-7177](tel:+86-512-6661-7177)

Fax: [+86-512-6661-7277](tel:+86-512-6661-7277)

Web: <http://www.instek.com.cn>

Email: [marketing@instek.com.cn](mailto:marketing@instek.com.cn)

### GOODWILL INSTRUMENT EURO B.V.

De Run 5427A, 5504DG Veldhoven, The Netherlands

Tel: [+31-\(0\)40-2557790](tel:+31-(0)40-2557790)

Fax: [+31-\(0\)40-2541194](tel:+31-(0)40-2541194)

Email: [sales@gw-instek.eu](mailto:sales@gw-instek.eu)



# INDEX

Accessories .....	11	overview .....	13, 20
Command set		Fuse	
CALCulate commands.....	204	AC fuse replacement.....	240
CONFigure commands.....	200, 201	safety instruction .....	7
ROUTE commands .....	231	<b>Getting Started chapter</b> .....	9
STATus report commands .....	224, 229	GPIB configuration.....	163, 167
SYSTEM related commands .....	217, 220	GPIB installation .....	162
CONFigure Commands.....	209	Indicator	
Crest factor.....	31, 32	reading.....	26
DATA Commands.....	210	Line voltage safety instruction .....	6
Declaration of conformity .....	249	Main features .....	10
Digital filter		MEASure Commands.....	213
setting .....	41	Measurement keys	
window.....	42	overview .....	14
Digital I/O		Rear panel	
Compare application .....	55, 64, 66, 68, 70	overview .....	17
configuration .....	55	Refresh rate .....	26
External trigger application .....	72	Remote control	
User mode.....	64	Command list.....	192, 193, 194, 195, 196, 197, 198, 199
DIGital INTerface Commands .....	211	Command syntax .....	189
DISPlay Commands .....	212	Remote terminal session	
Disposal instructions.....	8	telnet .....	183
EN 61010		RS-232C configuration .....	152
measurement category .....	6	Safety instruction	
pollution degree .....	8	fuse .....	7
Environment		Line voltage.....	6
operation.....	7	symbol .....	5
storage .....	8	SENSe AVERAge Commands .....	214
Ethernet configuration		SENSe Related Commands .....	213
activation.....	168	SENSe VOLTage Commands .....	215
DHCP .....	170	Specifications	
IP 171		DC	
Front panel		characteristics .....	247

measuring characteristics .....	247	external .....	37
Dimensions .....	248	Triggering .....	27
General .....	246	Voltage	
Status system .....	235	setting .....	28
Table of contents .....	3	Web control	
Trigger		overview .....	184
delay .....	40	Web control interface .....	184