

Multiplex Scanner Box

GSB-01/GSB-02

QUICK START GUIDE

GW INSTEK PART NO. 82SB-02000M01



ISO-9001 CERTIFIED MANUFACTURER

GW INSTEK

This manual contains proprietary information, which is protected by copyright. All rights are reserved. No part of this manual may be photocopied, reproduced or translated to another language without prior written consent of Good Will company.

The information in this manual was correct at the time of printing. However, Good Will continues to improve products and reserves the right to change specification, equipment, and maintenance procedures at any time without notice.

Good Will Instrument Co., Ltd.
No. 7-1, Jhongsing Rd., Tucheng Dist., New Taipei City 236, Taiwan.

Table of Contents

SAFETY INSTRUCTIONS	4
Safety Symbols.....	4
Safety Guidelines	5
Power cord for the United Kingdom	8
INTRODUCTION	9
Series lineup	9
Firmware Note	9
Model Overview.....	10
Main Features.....	10
Accessories and Package Contents.....	11
Panel Overview	12
Appearance	12
GSB-01 Front Panel	12
GSB-02 Front Panel	12
GSB-01 Rear Panel.....	13
GSB-02 Rear Panel.....	13
Test Lead Connection.....	14
Connecting GSB-01 Units	14
Connecting GSB-02 Units	17
OPERATION	20
Menu Tree.....	20
Common Utility Settings.....	21
Scan Configuration.....	23

S SAFETY INSTRUCTIONS

This chapter contains important safety instructions that you must follow during operation and storage. Read the following before any operation to ensure your safety and to keep the instrument in the best possible condition.

Safety Symbols

These safety symbols may appear in this manual or on the instrument.



WARNING

Warning: Identifies conditions or practices that could result in injury or loss of life.



CAUTION

Caution: Identifies conditions or practices that could result in damage to the instrument or to other properties.



DANGER High Voltage



Attention Refer to the Manual



Protective Conductor Terminal



Frame or Chassis Terminal



Earth (ground) Terminal



Do not dispose electronic equipment as unsorted municipal waste. Please use a separate collection facility or contact the supplier from which this instrument was purchased.

Safety Guidelines

General Guideline



CAUTION

- Do not place any heavy object on the instrument.
- Avoid severe impact or rough handling that leads to damaging the instrument.
- Do not discharge static electricity to the instrument.
- Use only mating connectors, not bare wires, for the terminals.
- Do not block the cooling fan opening.
- Do not disassemble the GSB-01/GSB-02 unless you are qualified.

(Measurement categories) EN 61010-1:2010 specifies the measurement categories and their requirements as follows. The GSB-01/GSB-02 falls under category II.

- Measurement category IV is for measurement performed at the source of low-voltage installation.
- Measurement category III is for measurement performed in the building installation.
- Measurement category II is for measurement performed on the circuits directly connected to the low voltage installation.

Power Supply



WARNING

- AC Input voltage range: 100 - 240VAC $\pm 10\%$
 - Frequency: 50Hz/60Hz
 - To avoid electrical shock connect the protective grounding conductor of the AC power cord to an earth ground.
-

Fuse



WARNING

- Fuse Type: T 2A/250V
- To ensure fire protection, replace the fuse only with them specified type and rating.
- Disconnect the power cord before replacing the fuse.
- Make sure the cause of the fuse blowout is fixed before replacing the fuse.

Cleaning the
GSB-01/GSB-02

- Disconnect the power cord before cleaning.
- Use a soft cloth dampened in a solution of mild detergent and water. Do not spray any liquid.
- Do not use chemicals containing harsh material such as benzene, toluene, xylene, and acetone.

Operation
Environment

- Location: Indoor, no direct sunlight, dust free, almost non-conductive pollution (Note below)
- Relative Humidity: $\leq 70\%$ (no condensation)
- Altitude: $< 2000\text{m}$
- Temperature: $0^{\circ}\text{C}\sim 40^{\circ}\text{C}$

(Pollution Degree) EN 61010-1:2010 specifies the pollution degrees and their requirements as follows. The GSB-01/GSB-02 falls under degree 2.

Pollution refers to “addition of foreign matter, solid, liquid, or gaseous (ionized gases), that may produce a reduction of dielectric strength or surface resistivity”.

- Pollution degree 1: No pollution or only dry, non-conductive pollution occurs. The pollution has no influence.
- Pollution degree 2: Normally only non-conductive pollution occurs. Occasionally, however, a temporary conductivity caused by condensation must be expected.
- Pollution degree 3: Conductive pollution occurs, or dry, non-conductive pollution occurs which becomes conductive due to condensation which is expected. In such conditions, equipment is normally protected against exposure to direct sunlight, precipitation, and full wind pressure, but neither temperature nor humidity is controlled.

Storage environment

- Location: Indoor
 - Temperature: -10°C to 70°C
 - Relative Humidity: $\leq 85\%$ (no condensation)
-

Disposal

Do not dispose this instrument as unsorted municipal waste. Please use a separate collection facility or contact the supplier from which this instrument was purchased. Please make sure discarded electrical waste is properly recycled to reduce environmental impact.

Power cord for the United Kingdom

When using the scanner box in the United Kingdom, make sure the power cord meets the following safety instructions.

NOTE: This lead/appliance must only be wired by competent persons

 WARNING: THIS APPLIANCE MUST BE EARTHED

IMPORTANT: The wires in this lead are coloured in accordance with the following code:

Green/ Yellow:	Earth
Blue:	Neutral
Brown:	Live (Phase)



As the colours of the wires in main leads may not correspond with the coloured marking identified in your plug/appliance, proceed as follows:

The wire which is coloured Green & Yellow must be connected to the Earth terminal marked with either the letter E, the earth symbol  or coloured Green/Green & Yellow.

The wire which is coloured Blue must be connected to the terminal which is marked with the letter N or coloured Blue or Black.

The wire which is coloured Brown must be connected to the terminal marked with the letter L or P or coloured Brown or Red.

If in doubt, consult the instructions provided with the equipment or contact the supplier.

This cable/appliance should be protected by a suitably rated and approved HBC mains fuse: refer to the rating information on the equipment and/or user instructions for details. As a guide, a cable of 0.75mm² should be protected by a 3A or 5A fuse. Larger conductors would normally require 13A types, depending on the connection method used.

Any exposed wiring from a cable, plug or connection that is engaged in a live socket is extremely hazardous. If a cable or plug is deemed hazardous, turn off the mains power and remove the cable, any fuses and fuse assemblies. All hazardous wiring must be immediately destroyed and replaced in accordance to the above standard.

INTRODUCTION

This Quick Start Guide is intended as a fast introduction to operating the GSB-01/02 scanner boxes with the GPT-9000 safety testers. This Quick Start Guide assumes that the user is familiar with the GPT-9000 series safety testers.

For comprehensive instructions, please see the User Manual, located on the accompanying CD.

Series lineup

The aim of these scanner boxes is to allow multiple DUTs to be tested either concurrently or in sequence using the GPT-9800, GPT-9900 or GPT-9900A safety testers. The scanner boxes are particularly well suited for multi-point safety testing as well for volume testing on factory floors.

The GSB-01 has connections for ACW, DCW and IR testing, while the GSB-02 also includes support for GB testing.

Firmware Note

Please make sure the firmware is up to date before using the scanner boxes. Please see the user manual to check the firmware version.

GPT-9800: firmware version V3.0 or above

GPT-9900/9900A: firmware version V2.0 or above

Note: Throughout this guide, the terms scanner box or GSB will refer to either model (GSB-01, GSB-02) unless specifically stated otherwise. GPT-9000 will refer to any of the GPT-9800, GPT-9900 or GPT-9900A safety testers, unless stated otherwise. HV and H will refer to High Voltage terminals, while LO and L will refer to the return terminal.

Model Overview

Model name	ACW	DCW	IR	GB	Outputs
GSB-01	✓	✓	✓		8 x HV
GSB-02	✓	✓	✓	✓	6 x HV, 2 x GB

Main Features

- Performance
- 8 HV outputs (6 for GSB-02)
 - 2 GB outputs (GSB-02 only)
 - ACW: 5kV AC
 - DCW: 6kV DC
 - IR: 1kV DC
 - GB: 40A (GSB-02 only)

- Features
- PASS/FAIL LEDs
 - HI LO LEDs
 - Up to 4 scanner boxes can be connected
-

- Interface
- RS-232 interface

Accessories and Package Contents

Standard Accessories	Part number	Description
	N/A	GSB-01/02 unit
	N/A	Quick start guide
	N/A	User manual CD
	Region dependent	Power cord
	GHT-108 x1	High voltage wiring leads
	GHT-109 x1	GB wiring leads (GSB-02 only)
	GHT-116R x8(GSB-01), x6(GSB-02)	HV test leads for scanner box outputs
	GHT-116B x1	Return test lead for scanner box
	GTL-116R x2	GB sense/source H test lead (GSB-02 only)
	GTL-116B x1	GB sense/source L test lead (GSB-02 only)
	GTL-235	RS232C Cable



Note

Keep the packaging, including the box, polystyrene foam and plastic envelopes should the need arise to return the unit to GW Instek.

Panel Overview

Appearance

GSB-01 Front Panel

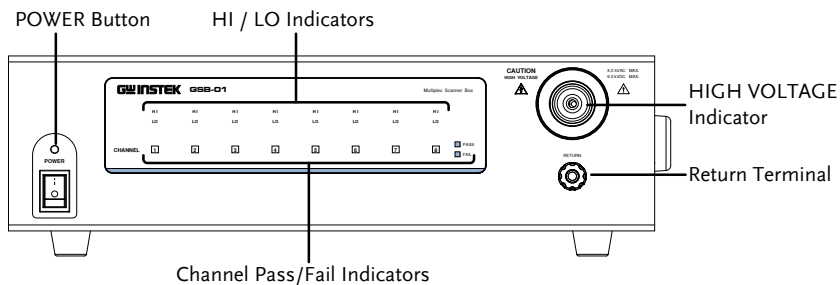

GSB-02 Front Panel

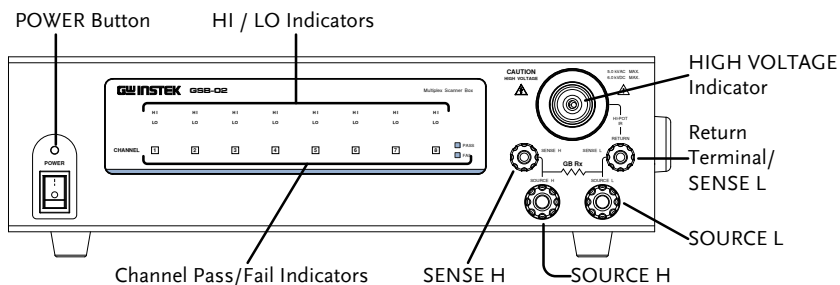

GSB-01 Rear Panel

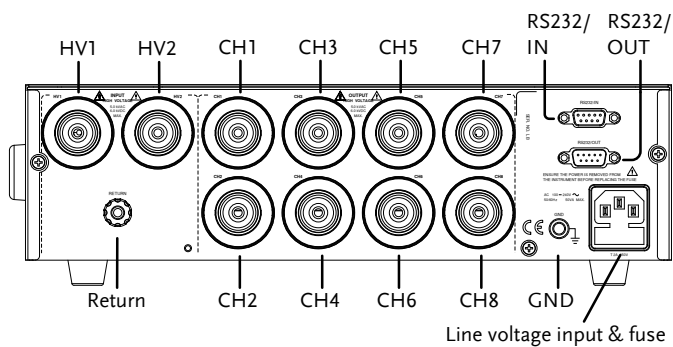

GSB-02 Rear Panel

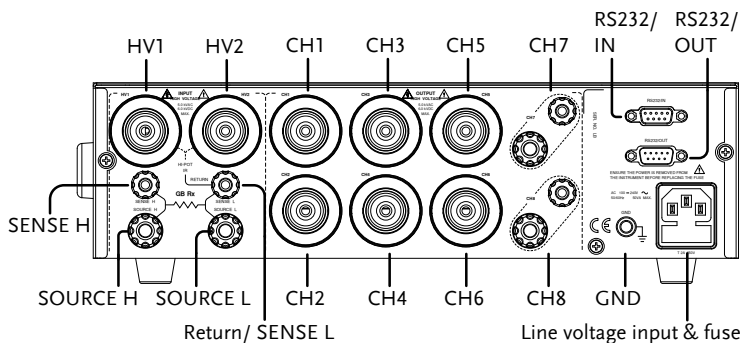

Test Lead Connection

This section describes how to connect the GPT-9000 to a number of scanner boxes. It is recommended that only models of the same type are connected together.

Connecting GSB-01 Units ---

**WARNING**

Ensure the safety tester is off when connecting the scanner boxes to the safety tester.

When wiring the GSB-01 scanner boxes to the safety tester or to each other, only the HV wiring leads (GHT-108) should be used.

Front Panel

1. Connect the High Voltage terminal on the safety tester to the High voltage terminal on the 1st scanner box, as shown below.
 2. Connect the return terminal on the safety tester to the return terminal on the 1st scanner box.
 3. Connect the return terminal on the 2nd scanner box to the return terminal on the 3rd scanner box.
-

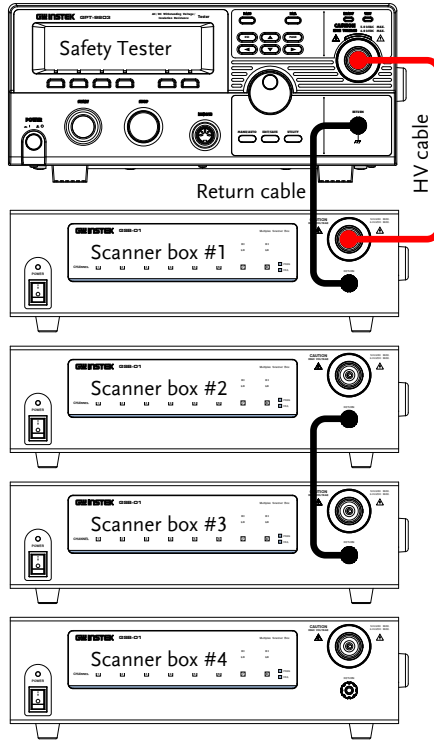

Rear Panel

1. Connect the rear panel HV terminals together on the scanners.

HV2 (box #1) → HV1 (box #2)

HV2 (box #2) → HV1 (box #3)

HV2 (box #3) → HV1 (box #4)

2. Connect the Return terminals together on scanners*.

Return (box #1) → Return (box #2)

Return (box #3) → Return (box #4)

*Box #2 does not need to be connected to box #3 as it was already connected from the front panel.

3. Connect the RS232C ports from the safety tester to each scanner box in a daisy chain using the RS232C cables.

RS232 (safety tester) → RS232/IN (box #1)
 RS232/OUT (box#1) → RS232/IN (box #2)
 RS232/OUT (box#2) → RS232/IN (box #3)
 RS232/OUT (box#3) → RS232/IN (box #4)

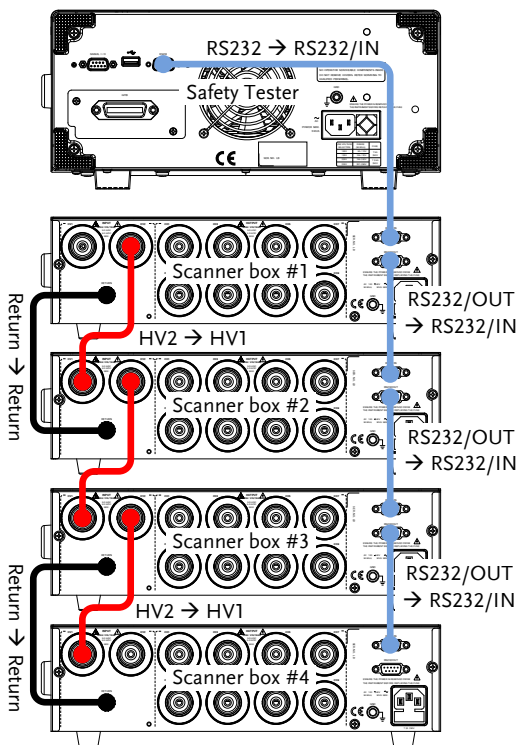

Connecting GSB-02 Units

Background The following will describe how to connect scanner boxes to a GPT-9000 series safety tester with ground bond test support. Up to 4 scanner boxes can be connected. In the examples below only 3 scanner boxes are connected.

When wiring the GSB-02 scanner boxes to the safety tester or to each other, only the GB wiring leads (GHT-109) should be used.

- Front Panel**
1. Connect the SOURCE H and SOURCE L terminals on the safety tester to the same terminals on the 1st scanner box.
 2. Connect the SENSE H and SENSE L terminals on the safety tester to the same terminals on the 1st scanner box.
-

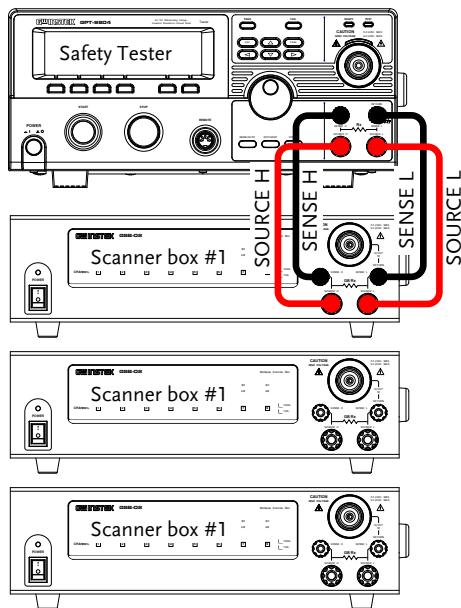

Rear Panel

1. Connect the SOURCE H and SOURCE L terminals on the 1st scanner box in series to the same terminals on the 2nd and 3rd scanner box.
2. Connect the SENSE H and SENSE L terminals on the 1st scanner box in series to the same terminals on the 2nd and 3rd scanner box.
3. Connect the RS232 ports from the safety tester to each scanner box in a daisy chain using the RS-232C cables.

RS232 (safety tester) → RS232/IN (box #1)
 RS232/OUT (box#1) → RS232/IN (box #2)
 RS232/OUT (box#2) → RS232/IN (box #3)

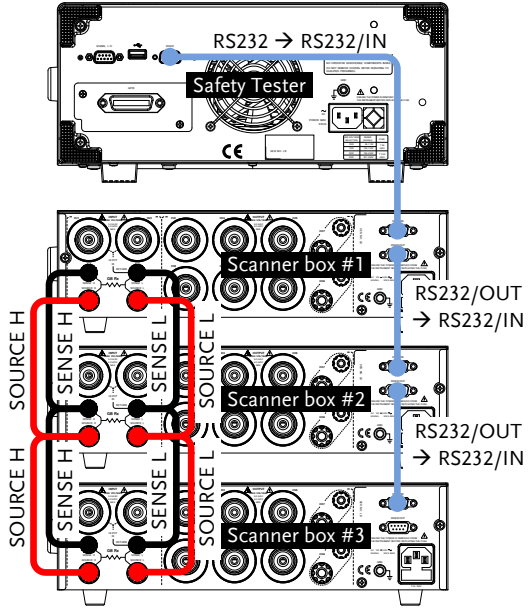

OPERATION

Menu Tree

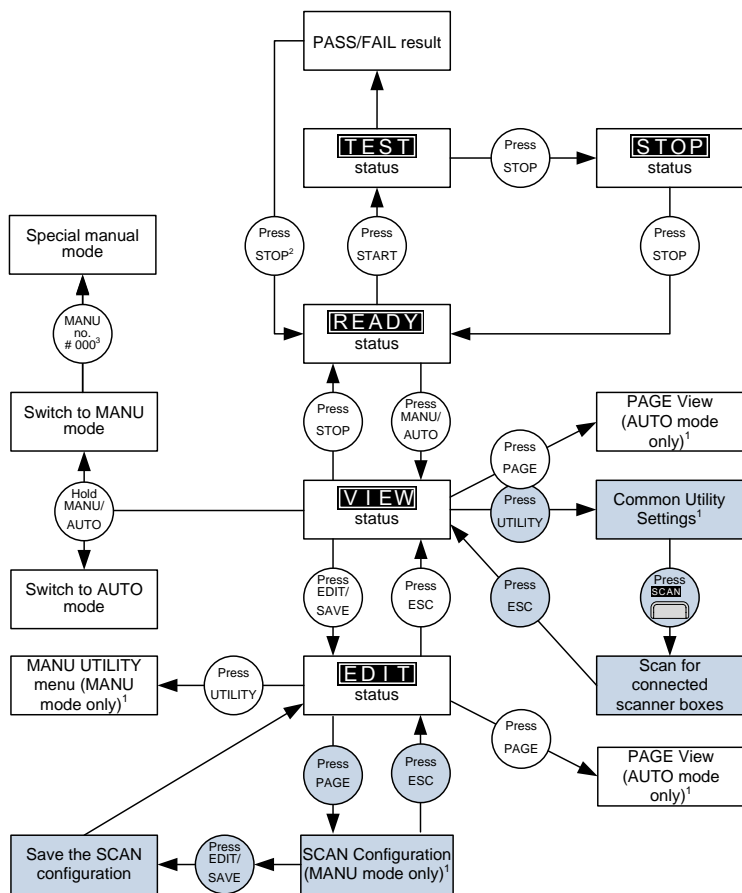

1 Press EDIT/SAVE to save settings, or ESC to cancel and return to the previous screen.

2 Press the STOP key twice for a FAIL result.

3 When in MANU mode, selecting MANU number 000 will enter the special manual mode.

4 The Sweep mode function is only accessible in the special manual mode.

When the scanner boxes are added to the GPT-9000 safety tester the scan utility and the scanner configuration menu become available. These additional menu functions are highlighted in the menu tree above and in the descriptions below.

Common Utility Settings

Description The Common Utility menu gains two functions.

1. A function to scan for connected scanner boxes. This allows you to check that all scanner boxes are properly connected to the GPT-9000 safety tester.
2. A new interface setting for remote control when using the scanner boxes.

The Common Utility settings include:

LCD: Contrast, Brightness

BUZZ: Pass Sound, Fail Sound

INTR: Interface (RS232, USB, **SCANNER**), Baud

CTRL: Start Ctrl (FRONT PANEL, SIGNAL I/O, REMOTE CONNECT), Double Action, Key Lock, Interlock

SCAN: Scans the connected scanner boxes.

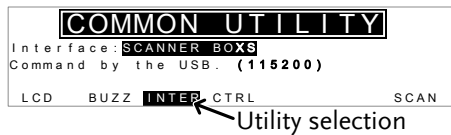

The Common Utility menu is accessed by pressing the UTILITY key when the tester is in VIEW status.



Select a Utility Setting.

(Example)

- Choose a utility by pressing the corresponding LCD, BUZZ, INTER, CTRL or **SCAN** soft-key.
 - **If SCAN was chosen, the connected scanner boxes will be listed.**
- The chosen utility will be displayed.
- Use the UP/DOWN arrow keys to highlight a setting.
- Use the scroll wheel to choose a parameter for the setting.

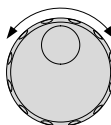

NOTE

The INTERLOCK function is set to OFF by default in the Common Utility>CTRL menu. To increase safety, set INTERLOCK to ON and use the accompanying Interlock key to enable testing.

If the SCANNER interface setting was chosen, the unit will default to USB for the remote control interface.

Save the Common Utility Setting

- To save any changes, press the EDIT/SAVE key.

EDIT/SAVE



The tester will return to the VIEW status.

Cancel and Exit the Common Utility Menu

- To exit and cancel any changes, press the ESC key.

ESC



The tester will return to the VIEW status.

Scan Configuration

Description The scanner box configuration is accessed by pressing the PAGE key when the tester is in MANU mode/EDIT status.

The scanner box output is configured separately for each manual test. This allows you to have one manual test to test multiple DUTs at the same time from a number of scanner boxes.

For automatic tests, each manual test can be seen as configuring the output of one step of the automatic test.

This section will assume that you are only configuring a single manual test. For automatic tests, configure the scanner boxes for each manual test that is added to the automatic test.

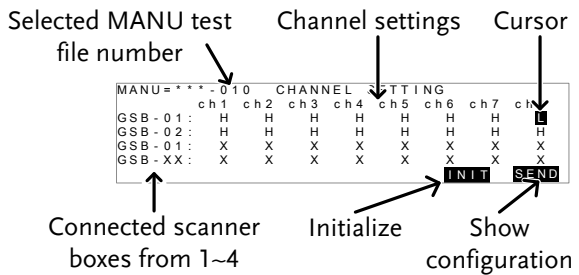

Move Cursor

- Use the arrow keys to move the cursor.
- Use the scroll wheel to set the output to H(HV), L(Return) or X(Disable).
- GB outputs can only be set to L or X.

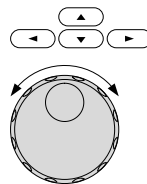

Initialize Settings

- Press INIT to initialize all the terminals to X (disable).



View Output Settings

- Press SEND so as to have the scanner box configuration displayed on the scanner displays.



Save Configuration

- To save, press the EDIT/SAVE key.



The tester will return to the EDIT status.

Cancel and Exit Page View

- To exit and cancel any changes, press the ESC key.



The tester will return to the EDIT status.