

# Programmable AC Power Supply

ASD-1900

---

**USER MANUAL**



ISO-9001 CERTIFIED MANUFACTURER

**GW INSTEK**

This manual contains proprietary information, which is protected by copyright. All rights are reserved. No part of this manual may be photocopied, reproduced or translated to another language without prior written consent of Good Will company.

The information in this manual was correct at the time of printing. However, Good Will continues to improve products and reserves the rights to change specification, equipment, and maintenance procedures at any time without notice.

**Good Will Instrument Co., Ltd.**  
**No. 7-1, Jhongsing Rd., Tucheng Dist., New Taipei City 236, Taiwan.**

# Table of Contents

<b>SAFETY INSTRUCTIONS</b> .....	<b>5</b>
<b>GETTING STARTED</b> .....	<b>9</b>
Main Features .....	11
Appearance .....	13
<b>INSTALLATION</b> .....	<b>18</b>
Preparation for Use .....	19
Requirements of Input Power .....	19
Input Connection .....	20
Output Connection .....	22
Remote Sense Connection .....	23
Power on .....	25
<b>LOCAL OPERATION</b> .....	<b>27</b>
Operation through Keypad and Knob .....	29
Menu Tree .....	31
Main Menu Setting .....	32
Advanced Parameter Setting Menu .....	38
SETUP Function .....	39
CONFIG Function .....	58
<b>APPLICATION</b> .....	<b>69</b>
LIST Mode .....	70
PULSE Mode .....	75
STEP Mode .....	78
SYNTHESIS Self-Defined Waveform Mode .....	81
<b>SAVE AND RECALL</b> .....	<b>84</b>
System parameter Save and Recall .....	85

<b>REMOTE OPERAION.....</b>	<b>87</b>
Set GPIB address and RS-232 Parameters .....	88
Programming.....	90
Command List .....	93
Command for Remote Control .....	96
<b>APPENDIX.....</b>	<b>128</b>
Protection .....	130
Specifications .....	132
Certificate Of Compliance .....	136
TTL Pin Assignment.....	137
Built In Waveforms .....	138

# S SAFETY INSTRUCTIONS

This chapter contains important safety instructions that you must follow during operation and storage. Read the following before any operation to insure your safety and to keep the instrument in the best possible condition.

## Safety Symbols

These safety symbols may appear in this manual or on the instrument.

---



WARNING

Warning: Identifies conditions or practices that could result in injury or loss of life.



CAUTION

Caution: Identifies conditions or practices that could result in damage to the ASD-1900 or to other properties.



DANGER High Voltage



Attention Refer to the Manual



Protective Conductor Terminal



Earth (ground) Terminal



Do not dispose electronic equipment as unsorted municipal waste. Please use a separate collection facility or contact the supplier from which this instrument was purchased.

## Safety Guidelines

---

### General Guideline



#### CAUTION

- Do not place any heavy object on the ASD-1900.
- Avoid severe impact or rough handling that leads to damaging the ASD-1900.
- Do not discharge static electricity to the ASD-1900.
- Use only mating connectors, not bare wires, for the terminals.
- Do not block the cooling fan opening.
- Do not disassemble the ASD-1900 unless you are qualified.

(Measurement categories) EN61010-1:2010 and EN61010-2-030 specifies the measurement categories and their requirements as follows. The ASD-1900 falls under category II.

- Measurement category IV is for measurement performed at the source of low-voltage installation.
- Measurement category III is for measurement performed in the building installation.
- Measurement category II is for measurement performed on the circuits directly connected to the low voltage installation.
- 0 is for measurements performed on circuits not directly connected to Mains.

---

### Power Supply



#### WARNING

- AC Input voltage range: 85Vac~265Vac
- Frequency: 47Hz to 63Hz
- To avoid electrical shock connect the protective grounding conductor of the AC power cord to an earth ground.

---

### Cleaning the ASD-1900

- Disconnect the power cord before cleaning.
  - Use a soft cloth dampened in a solution of mild detergent and water. Do not spray any liquid.
  - Do not use chemicals containing harsh material such as benzene, toluene, xylene, and acetone.
-

Operation Environment	<ul style="list-style-type: none"><li>• Location: Indoor, no direct sunlight, dust free, almost non-conductive pollution (Note below)</li><li>• Relative Humidity: 20%~ 85% (no condensation)</li><li>• Altitude: &lt; 2000m</li><li>• Temperature: 0°C to 50°C</li></ul> <p>(Pollution Degree) EN61010-1:2010 and EN61010-2-030 specifies the pollution degrees and their requirements as follows. The ASD-1900 falls under degree 2.</p> <p>Pollution refers to “addition of foreign matter, solid, liquid, or gaseous (ionized gases), that may produce a reduction of dielectric strength or surface resistivity”.</p> <ul style="list-style-type: none"><li>• Pollution degree 1: No pollution or only dry, non-conductive pollution occurs. The pollution has no influence.</li><li>• Pollution degree 2: Normally only non-conductive pollution occurs. Occasionally, however, a temporary conductivity caused by condensation must be expected.</li><li>• Pollution degree 3: Conductive pollution occurs, or dry, non-conductive pollution occurs which becomes conductive due to condensation which is expected. In such conditions, equipment is normally protected against exposure to direct sunlight, precipitation, and full wind pressure, but neither temperature nor humidity is controlled.</li></ul>
Storage environment	<ul style="list-style-type: none"><li>• Location: Indoor</li><li>• Temperature: -25°C to 70°C</li><li>• Relative Humidity: ≤90% (no condensation)</li></ul>
Disposal	 <p>Do not dispose this instrument as unsorted municipal waste. Please use a separate collection facility or contact the supplier from which this instrument was purchased. Please make sure discarded electrical waste is properly recycled to reduce environmental impact.</p>

## Power cord for the United Kingdom

When using the power supply in the United Kingdom, make sure the power cord meets the following safety instructions.

NOTE: This lead/appliance must only be wired by competent persons



**WARNING: THIS APPLIANCE MUST BE EARTHED**

IMPORTANT: The wires in this lead are coloured in accordance with the following code:

Green/ Yellow:	Earth
Blue:	Neutral
Brown:	Live (Phase)



As the colours of the wires in main leads may not correspond with the coloured marking identified in your plug/appliance, proceed as follows:

The wire which is coloured Green & Yellow must be connected to the Earth terminal marked with either the letter E, the earth symbol  or coloured Green/Green & Yellow.

The wire which is coloured Blue must be connected to the terminal which is marked with the letter N or coloured Blue or Black.

The wire which is coloured Brown must be connected to the terminal marked with the letter L or P or coloured Brown or Red.

If in doubt, consult the instructions provided with the equipment or contact the supplier.

This cable/appliance should be protected by a suitably rated and approved HBC mains fuse: refer to the rating information on the equipment and/or user instructions for details. As a guide, a cable of 0.75mm<sup>2</sup> should be protected by a 3A or 5A fuse. Larger conductors would normally require 13A types, depending on the connection method used.

Any exposed wiring from a cable, plug or connection that is engaged in a live socket is extremely hazardous. If a cable or plug is deemed hazardous, turn off the mains power and remove the cable, any fuses and fuse assemblies. All hazardous wiring must be immediately destroyed and replaced in accordance to the above standard.



# G E T T I N G   S T A R T E D

This manual describes the specifications, installation and operation instructions of GW ASD-1900 Programmable AC Power Source. In this manual the term, AC Source, stands for GW ASD-1900 Programmable AC Source.

The series of AC source is a high efficiency programmable ac power source, which provides low distortion sinusoid AC voltage output and measurement. Stable voltage and frequency are obtained through accurate digital calculation provided by DSP IC. Remote programming is accomplished either by the GPIB bus or the RS-232C serial port.

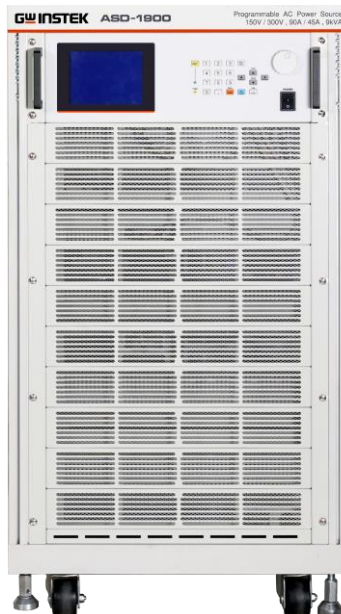

Main Features .....	11
Accessories .....	12
Appearance.....	13
Front Panel.....	13
Rear Panel.....	16

## Main Features

---

Configuration	<ul style="list-style-type: none"><li>• Local operation from the front panel keypad.</li><li>• Protection against Over-power, Over-load, Over-temperature and Fan-fail.</li><li>• Fan speed controlled by output power.</li><li>• Built-in isolation output relays.</li><li>• Remote operation via GPIB or RS-232C interface.</li></ul>
Input/output	<ul style="list-style-type: none"><li>• Selective output voltage ranges with full scale of 150V/32A and 300V/16A</li><li>• V, I, F, P, CF, PF, Ip, Is, VA and VAR measurements</li><li>• Remote inhibit control</li><li>• AC ON/OFF, FAULT OUT TTL output signal.</li></ul>

---

### Accessories







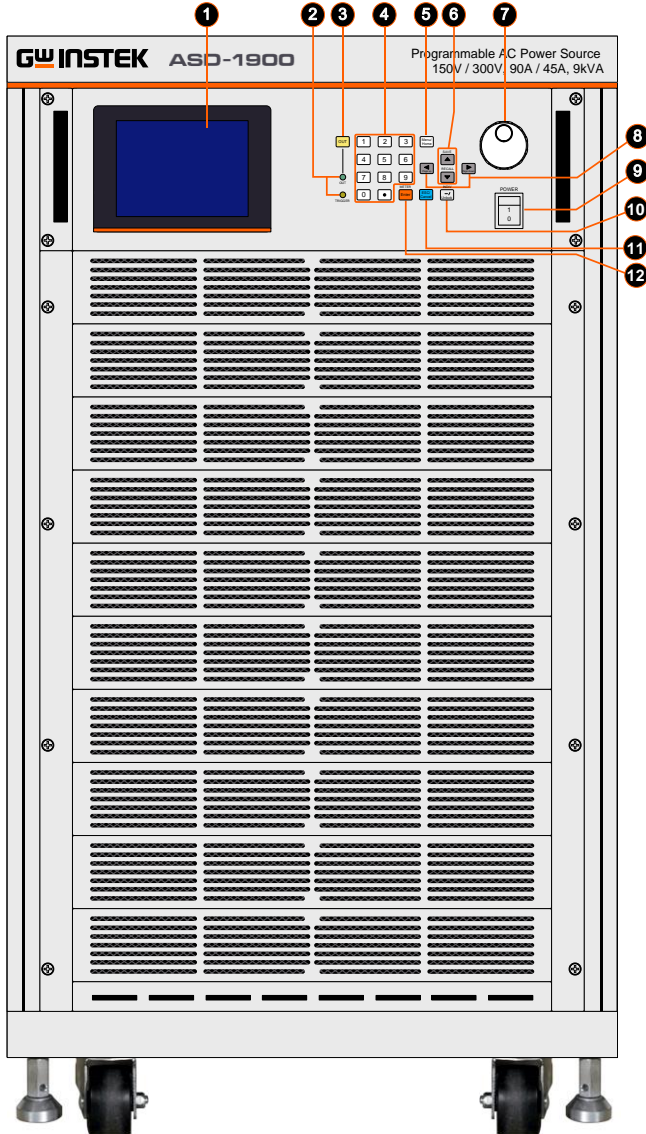

Please check the following accessories are included and not damaged during shipment. If there are damaged or shortage of the accessories, please contact GW Instek electronics or sales agent for help.





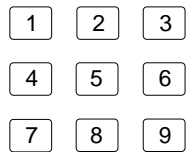

Standard Accessories			
Part number	Description	Qty.	
364456180X	Input cable (3m)	1	
364456170X	Output cable (3m)	3	
Optional Accessories			
Part number	Description	Qty.	
308006150X	GPIB cable(1.0m)	1	
308006140X	GPIB cable(2.0m)	1	
308006130X	GPIB cable(4.0m)	1	
308006120X	GPIB cable(8.0m)	1	
308006110X	GPIB cable(0.5m)	1	

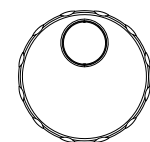
# Appearance

## Front Panel

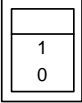

Item	Symbol	Description
1		LCD panel, display setting and measurement results.
2	 LED indicator: Trigger 	<ul style="list-style-type: none"> <li>• OUT(green)indicates AC source normal output</li> <li>• TRIGGER(yellow)indicates LIST, PULSE, STEP output</li> </ul>
3		Press this key to control ON/OFF state of AC output voltage
4	 	Digital numerical keypad group: Used for parameter setting
5		At main menu page, press this key to enter “advanced parameter setting” page; at other pages, press this key to return to main menu.
6	 SAVE RECALL 	Short press: Cursor move upward or downward. Long press: long press at “main menu” “advanced parameters setting menu” pages, will enter “save, restore” page.
7		Knob: Used for parameters setting or selection

- 8   At main menu page, press this key to enter “advanced parameter setting” page; at other pages, press this key to return to main menu
- 9  Main switch: Turn on/off the AC power input
- 10  Back to local control in remote mode, negative sign in panel control
- 11  Escape current page (ESC) or cancel current settings (Cancel)
- 12  Confirm parameter setting

Rear Panel

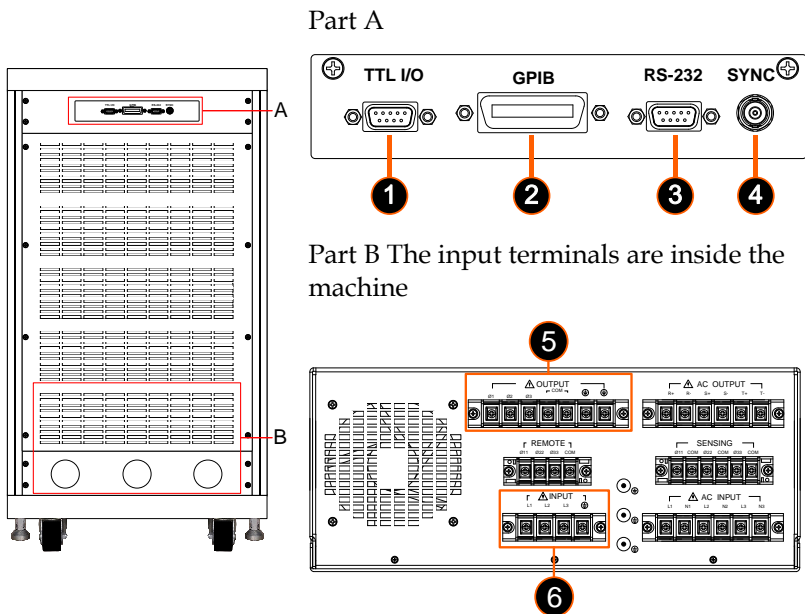

Item	Name	Description
1	TTL I/O port	The 9-pin, D-type female connector conveys TTL signals (AC_ON, FAULT_OUT and REMOTE_INHIBIT)
2	GPIB connector	IEEE 488 standard connector, for remote control.
3	RS-232 port	D type 9 pin female connector, for remote control.
4	SYNC port	When output change according new parameter setting, SYNC will output Synchronized signal.
5	Output connector	Output connector. Outputs power to the loading device.



- 6 Power Line input Connector Input connector. Please refer to page 20 for connection

# INSTALLATION

First, inspect any damage that may have occurred during the shipment after unpacking the instrument. Save all packing materials in case the instrument has to be returned.

If any damage is found, please file a claim against the carrier immediately. Do not return the instrument to the factory without obtaining the prior RMA acceptance from GW Instek.

---

Preparation for Use .....	19
Requirements of Input Power .....	19
Rating .....	19
Input Connection .....	20
Output Connection .....	22
Remote Sense Connection .....	23
Power on .....	25

## Preparation for Use

Before start using, the instrument must be connected with an appropriate AC line input. As the instrument is cooled by fans, it must be installed in an area with sufficient space for air circulation. It should be used in an area where the environment temperature does not exceed 40°C.

## Requirements of Input Power

### Rating

Input voltage Range	190-250VLL 3 phases 4 wires $\Delta$ (ABT A), or 329-433VLL3 phases 5 wires Y (ABT B)
---------------------	--

Input Frequency	47-63Hz
-----------------	---------

Max. Current/Phase	35A/(ABT A) or 25A/(ABT B)
--------------------	----------------------------



Caution

The AC source may be damaged if it is operated at an input voltage that is over its configured input range.

## Input Connection

The input terminal block is located on the instrument rear panel. The temperature rating of the power cord must be rated at least for 85°C. The current rating of input power line must be greater than or equal to the maximum current rating of the AC source.

It is recommended to put a 40A breaker (ABT A) (30A breaker (ABT B)) on AC input side.



There are two input voltage rating models, one is 380 VLL 3 $\phi$ 5 wires (Y connection) used for (ABT B model), and the other is 220 VLL 3 $\phi$ 4 wires ( $\Delta$  connection) used for (ABT A model). Be careful to verify the model you have, and make sure that the main voltage is suitable for the model! AC source may not operate properly if one phase input voltage is missing, please recheck the connection.

See Figures below and do the following steps one by one.

### Steps

1. Remove the safety cover at the back side of AC source.
2. Connect the AC lines to the terminal blocks of the AC source.

220Vac 3 phase 4 wires  $\Delta$  Input Connection  
(ASD-1900 220V)

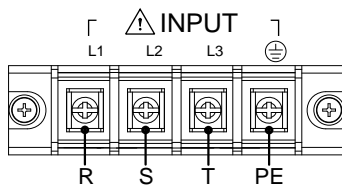

220V input terminal

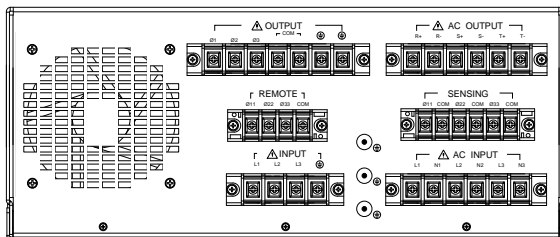

380Vac 3 phase 5  
wires Y Input  
Connection  
(ASD-1900 380V)

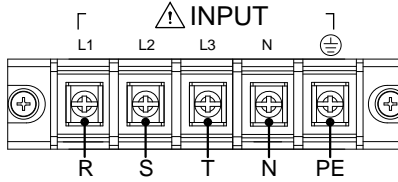

380V input  
terminal

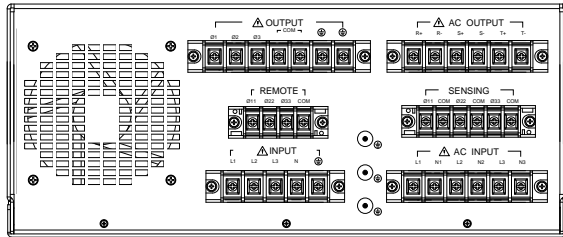

3. Make sure the removable safety cover does fully cover the AC input terminal.
4. Turn off AC power supply to AC source or make safety isolation before installing or taking off external terminal with hazard voltages.



To protect operators the wire connected to the GND terminal must be connected to the ground. Under no circumstances shall this AC source be operated without an adequate ground connection.

Installation of the AC input power cord must be done by professional personnel in accordance with local electrical codes.

## Output Connection

Output connection is different for single phase or three phase output, choose the correct one before connecting. Connect the load wire to "COM" and " $\phi 1/\phi 2/\phi 3$ " terminals as figures on next page. To meet the safety requirements the wires to the load must use gauges large enough to prevent from overheating while carrying the output current.

## Remote Sense Connection

The AC source remote sense function monitors the load terminal voltage instead of the AC source output terminal. It ensures the delivery of accurate voltage as programmed at the load by compensating the output voltage drop over the connecting cable automatically. You have to set Remote Sense ON so as to enable this function.

Connect the sensing wires from “ $\phi 11/\phi 22/\phi 33$ ” and “COM” terminals to the load as shown in figure below. As the sensing wires carry only a few milli-amperes, the wire gauges are much smaller than the load cables. The sensing wires are part of the feedback path of the AC source. They must be kept at a low resistance in order to maintain the best performance. Connect the sensing wires carefully so that they will not be open-circuited. If the sensing wires are left unconnected or become open-circuited during operation, the AC source will disable the output. The sensing wires must be a twisted pair to minimize the pickup of external noise. The sensing wires need to be connected as close to the load input terminal as possible.

Three phase output and remote sense connection

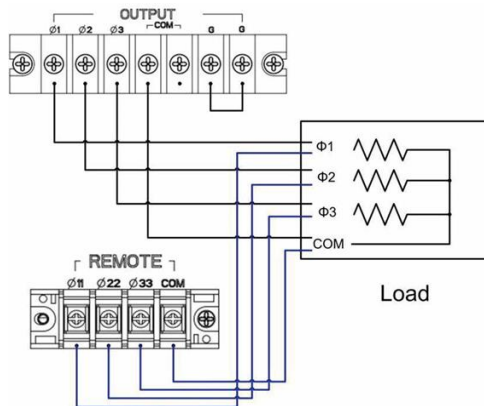

Single phase  
output and  
remote sense  
connection

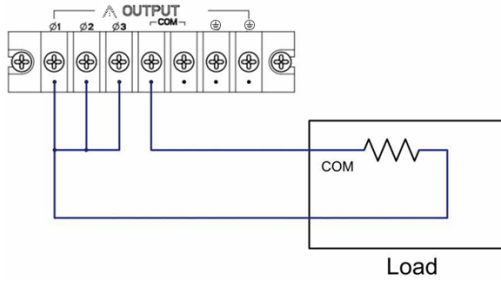



## Power on

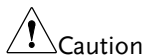

Caution

Before turning on the instrument, all protective earth terminals, extension cords and devices connected to the instrument must be connected to a protective ground. Any interruption of the protective grounding will cause a potential shock hazard that might injure people.

### Steps

1. Connect the AC voltage.
2. Turn on the power switch on the front panel.

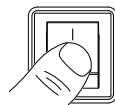

3. The AC source will do a series of self-tests when every time it is turned on. The LCD on the front panel will light up and display as below under normal condition.



4. After self-testing, AC source will enter main setting page (main menu) which is shown as below.

### Main setting page

SET MODE		Three(SYN.)	
→V	: 110.0	F	: 60.0
Meter Report: (Overview)			
V $\phi$ 1:	0.0	I $\phi$ 1:	0.00
V $\phi$ 2:	0.0	I $\phi$ 2:	0.00
V $\phi$ 3:	0.0	I $\phi$ 3:	0.00
P $\phi$ 1:	0.0	$\Sigma$ I	: 0.00
P $\phi$ 2:	0.0	$\Sigma$ P	: 0.0
P $\phi$ 3:	0.0	$\Sigma$ PF:	0.000

**Caution**

Error messages will show on the LCD panel if error occurs during turn on process. Please refer to page 130 for error code.

Digital circuit inside AC source may not operate properly if turn on AC source immediately after turn off. Recommend to wait 3 seconds to turn on AC source after it was turned off.

---

# LOCAL OPERATION

The AC source can be configured to operate in local or remote mode. The operation in remote mode through GPIB controller or RS-232C will be described in next chapter. This chapter describes the operation in local mode through the keypad on the front panel for data entry and test. If remote control cable isn't connected, the AC source is configured for local operation after AC switch is on.

---

Operation through Keypad and Knob .....	29
Menu Tree .....	31
Main Menu Setting .....	32
Set Voltage and Frequency .....	32
Single/Three Phase mode Display .....	34
Voltage output at Three(SYN.) mode .....	34
Display at single phase/ parallel mode .....	36
Advanced Parameter Setting Menu .....	38
SETUP Function .....	39
Definitions for all parameters on SETUP setting menu .....	41
Voltage Limit .....	42
I Limit, OCP Delay .....	43
Voltage Level Setting .....	45
Voltage Sense .....	46
Degree On, Off .....	47
Is Start, Is Interval .....	48
Waveform Selection .....	51
Buzzer .....	52
Disable (Lock) the Keys at Front Panel .....	53
Set Single / Three Phase Mode .....	54
Set Phase Shift for Three Phase Mode .....	56
CONFIG Function .....	58
Definitions for all parameters on CONFIG setting menu .....	58

Waveform A, B Generator.....	59
GPIB, RS232 Communication Setting.....	61
Switch menu to remote control.....	61
Switch from remote to local control .....	62
Switch remote control between GPIB or RS232 .....	62
Parameters setting for two interfaces .....	62
Inhibit Output by Remote Control Signal (Remote Inhibit) .....	64
Power On State .....	67

## Operation through Keypad and Knob

LCD panel will show the self-test message as below after AC switch is on.



Then will enter main menu setting page as below. Default SET MODE is "Three(SYN.)" means three phase output operation. Operator can set output voltage and frequency for three phase.

ASD-1900 provides a user-friendly programming interface by using the keypad on the front panel.

Main menu  
setting page

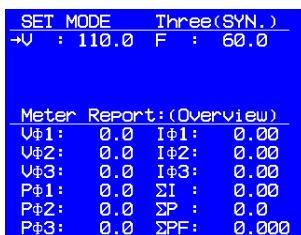

- Press **▲ Up arrow** or **▼ Down arrow** key to move cursor between voltage and frequency to make selection.
- Use numerical and decimal point key or knob to set number.
- Press **Enter** key to confirm setting.
- Press to **Menu/Home** key to enter advanced parameter setting menu as below.

Advanced  
parameter setting  
menu

```
PAGE SELECT :  
1. SETUP  
2. CONFIG  
3. LIST  
4. PULSE  
5. STEP  
6. SYNTHESIS
```

- User can make more detail setting from advanced parameter setting menu, or press **Menu/ Home** key again to return to main menu.
- On advanced parameter setting menu, user can press numerical key to do a selection.
- Press **Enter** key to enter individual parameter setting menu.
- After entering individual setting menu, press **▲ Up arrow** or **▼ Down arrow** key to move cursor to item which wants to modify.
- Use numerical key or knob to do the modification.
- Press **Enter** key to confirm setting.
- If there is "Press ◀▶ to switch page" shown at the bottom of menu, use **◀ Page up** or **▶ Page down** arrow key to switch menu page.
- When setting is finished, press **ESC/ Cancel** key to return back to advanced parameter setting menu, or press **Menu/ Home** key back to main menu.

# Menu Tree

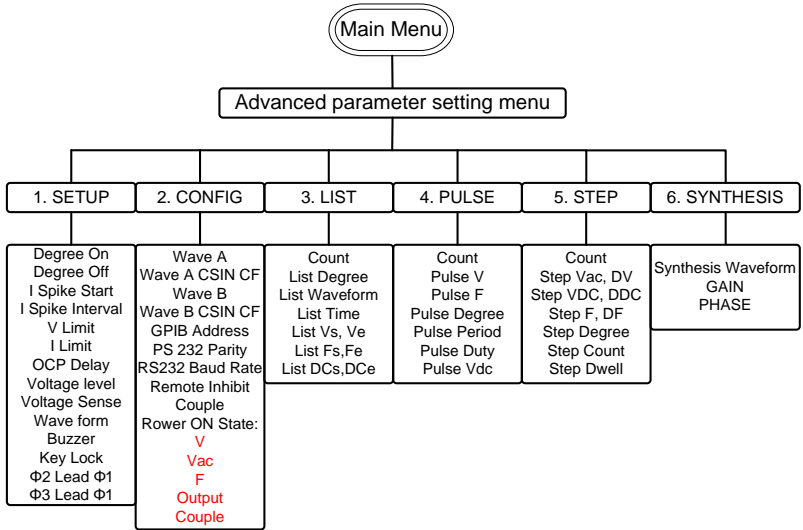

## Main Menu Setting

After the AC source is on and initialization is finished, screen will show the main menu. Default output voltage and frequency is 110V and 60Hz. Voltage and frequency setting shown on upper place on the screen, lower place of the screen shows the measurement value, example shown as below.

```

SET MODE      Three(SYN.)
+U : 110.0   F : 60.0

Meter Report : (Overview)
Vφ1 : 0.0   Iφ1 : 0.00
Vφ2 : 0.0   Iφ2 : 0.00
Vφ3 : 0.0   Iφ3 : 0.00
Pφ1 : 0.0   ΣI : 0.00
Pφ2 : 0.0   ΣP : 0.0
Pφ3 : 0.0   ΣPF : 0.000
  
```

- Displayed mode at upper place
- SET MODE: Setting mode, no voltage output from AC source.
  - OUT MODE: Output mode. When user press **OUT** key at SET MODE, AC source outputs voltage.

## Set Voltage and Frequency

There are three ways to set voltage and frequency at the main menu.

- Use numerical key to set parameter directly, then press **Enter** key to confirm.
- Use knob to do adjustment. Turn knob clockwise to increase parameter, turn knob anticlockwise to decrease parameter. Press **Enter** key to confirm.
- Use **◀** Page up or **▶** Page down arrow key to select position of digital, then use knob or numerical key to adjust parameter, press **Enter** key to confirm.

Example            Set V=220V and F=50Hz



- Operation step 1. Press **▲ Up arrow** or **▼ Down arrow** key to move cursor to *V* (default setting).

SET MODE	Three (SYN.)	
→V : 110.0	F :	60.0
Meter Report: (Overview)		
V $\phi$ 1:	0.0	I $\phi$ 1: 0.00
V $\phi$ 2:	0.0	I $\phi$ 2: 0.00
V $\phi$ 3:	0.0	I $\phi$ 3: 0.00
P $\phi$ 1:	0.0	$\Sigma$ I : 0.00
P $\phi$ 2:	0.0	$\Sigma$ P : 0.0
P $\phi$ 3:	0.0	$\Sigma$ PF: 0.000

2. Change parameter value to 220 by **numerical** key or **knob**. Then press **Enter** key to confirm setting.

SET MODE	Three (SYN.)	
→V : 220.0	F :	60.0
Meter Report: (Overview)		
V $\phi$ 1:	0.0	I $\phi$ 1: 0.00
V $\phi$ 2:	0.0	I $\phi$ 2: 0.00
V $\phi$ 3:	0.0	I $\phi$ 3: 0.00
P $\phi$ 1:	0.0	$\Sigma$ I : 0.00
P $\phi$ 2:	0.0	$\Sigma$ P : 0.0
P $\phi$ 3:	0.0	$\Sigma$ PF: 0.000

3. Press **▲ Up arrow** or **▼ Down arrow** key to move cursor to *F*

SET MODE	Three (SYN.)	
V : 220.0	→F :	60.0
Meter Report: (Overview)		
V $\phi$ 1:	0.0	I $\phi$ 1: 0.00
V $\phi$ 2:	0.0	I $\phi$ 2: 0.00
V $\phi$ 3:	0.0	I $\phi$ 3: 0.00
P $\phi$ 1:	0.0	$\Sigma$ I : 0.00
P $\phi$ 2:	0.0	$\Sigma$ P : 0.0
P $\phi$ 3:	0.0	$\Sigma$ PF: 0.000

4. Change parameter value to 50 by **numerical** key or **knob**. Then press **Enter** key to confirm setting.

OUT MODE		Three(SYN.)	
+V	: 220.0	F	: 50.0
Meter Report:(#1)			
V	: 220.0	I	: 1.00
VA	: 220.0	IP	: 1.50
VAR	: 0.0	IS	: 0.00
F	: 50.0	CF	: 1.500
P	: 220.0	PF	: 0.999

## Single/Three Phase mode Display

At main menu, press **OUT** key to change editing (setting) or output mode. At output mode, AC source outputs according the voltage and frequency set at main menu. Measurement values are shown at the lower position of the screen. Following explains the meaning of measurement information at different output mode (single phase or three phase)

### Voltage output at Three(SYN.) mode

At three phase mode, no individual phase measurement values shows, voltage measurement value is the average voltage of two phase, and current measurement value is the sum of two phase current. Individual phase measurement values can be queried through GPIB, RS232 interface.

Three phase  
output display

OUT MODE		Three(SYN.)	
+V	: 220.0	F	: 50.0
Meter Report:(Overview)			
V#1:	220.0	I#1:	1.00
V#2:	219.0	I#2:	1.01
V#3:	220.1	I#3:	0.99
P#1:	220.0	SI	: 3.00
P#2:	222.1	SP	: 660.0
P#3:	217.0	SPF	: 0.998

At output mode, press **Enter** key longer than 2 seconds to switch measurement contents between following two displays.

- Overview: Display voltage, current, power for each phase, total current, total power and average power factor.
- $\Phi(1\sim3)$ : Display all detail measurement values

for each phase.

```

OUT MODE      Three(SYN.)
→U : 220.0   F : 50.0

Meter Report:(#1)
U : 220.0   I : 1.00
VA : 220.0   IP : 1.50
VAR:  0.0   Is : 0.00
F :  50.0   CF : 1.500
P : 220.0   PF : 0.999

```

```

OUT MODE      Three(SYN.)
→U : 220.0   F : 50.0

Meter Report:(#2)
U : 219.9   I : 1.01
VA : 220.1   IP : 1.46
VAR:  0.0   Is : 0.00
F :  50.0   CF : 1.475
P : 222.1   PF : 0.999

```

```

OUT MODE      Three(SYN.)
→U : 220.0   F : 50.0

Meter Report:(#3)
U : 220.1   I : 1.01
VA : 217.9   IP : 1.48
VAR:  0.0   Is : 0.00
F :  50.0   CF : 1.465
P : 217.9   PF : 0.999

```

Meter Report display will keep unchanged until user switch display pages, for example users do operation as below. At OUT MODE switch to Meter Report  $\Phi 1$  then stop output and start again after set new parameters. During the process described above, Meter Report is stayed at  $\Phi 1$  until user **Enter** key longer than 2 seconds to switch to other pages.

### Display at single phase/ parallel mode

At parallel output mode, there is no individual phase information displayed. Voltage displayed is sum average of three phase voltage, current displayed is sum of three phase current. Individual phase measurement values can be queried by GPIB or RS232.

single phase/  
parallel output  
display

```

OUT MODE   Single Phase
+U : 110.0  F : 60.0

Meter Report
V : 110.0  I : 3.00
VA : 330.0  IP : 3.40
VAR: 0.0   Is : 0.00
F : 60.0   CF : 1.133
P : 330.0  PF : 0.999
    
```

Parameter  
definition of  
output setting

- V: Alternative current output voltage (Vrms), unit is volt.
- F: Output frequency, unit is Hertz.

Parameter  
definition of  
measurement

- V: Voltage (Vrms), voltage measurement value (root mean square), unit is Volt.
- VA: Apparent power, calculation equation is  $V_{rms} \times I_{rms}$ .
- VAR: Reactive power. Calculation equation is  $\sqrt{VA^2 - P^2}$
- F: Frequency, Hz is used as measurement value unit.
- P: Power, measurement vale use Watt as unit.
- I : Current (Irms), measurement value use Irms as unit.
- Ip: Peak current measurement value. Unit is Ampere.
- Is: Surge current measurement value. Unit is Ampere.
- CF: Crest Factor, calculation equation is  $I_{peak}/I_{rms}$ .
- PF: Power Factor measurement value.

Calculation equation is Real power/(Vrms x  
Irms).

---

## Advanced Parameter Setting Menu

---

- Operation step
- Press **Menu/ Home** key at main menu to enter advanced parameter setting menu.

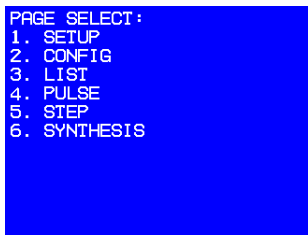

```
PAGE SELECT :  
1. SETUP  
2. CONFIG  
3. LIST  
4. PULSE  
5. STEP  
6. SYNTHESIS
```

- User can select an item from item 1~6, then press **Enter** key to enter individual setting menu; or press **Menu/ Home** key to return main menu.
  - When screen is not at main menu, press **Menu/ Home** key will return to main menu no matter which page it is at.
  - Press **ESC/ Cancel** key will back to advanced parameter setting menu.
-

## SETUP Function

- Operation step 1. Press **numerical** key **1** on the front panel to select *SETUP* option when the advanced parameter setting menu appears.

```
PAGE SELECT:
1. SETUP
2. CONFIG
3. LIST
4. PULSE
5. STEP
6. SYNTHESIS
```

2. Press **Enter** key to enter *SETUP* setting menu shown as figure below.

```
SETUP
-V Limit      : 300.0 V
 I Limit      : 48.00A
 OCP Delay    : 9.0 S
 Voltage Level: 300V
 Voltage Sense: Vout
 Degree On    : 0.0
 Degree OFF   : 0.0
 Is Start     : 0.0mS
 Is Interval  : 1.0mS
Press ←→ to switch Page
```

3. Press **Page down** key to move to next page.

```
SETUP
-Waveform     :A
 Buzzer       :ON
 KeyLock      :OFF
 Phase Sel.   :Three(SYN.)

OUT MODE  -Three Phase
φ2 Lead φ1:120.0
φ3 Lead φ1:240.0
Press ←→ to switch page
```

4. Press **Page up** key to return to previous page.

```
SETUP
-V Limit      : 300.0 V
I Limit       : 48.00A
OCP Delay     : 9.0 S
Voltage Level : 300V
Voltage Sense : Vout
Degree On     : 0.0
Degree Off    : 0.0
Is Start      : 0.0mS
Is Interval   : 1.0mS
Press ◀▶ to switch page
```



## Definitions for all parameters on SETUP setting menu

Parameter	Definition	Setting Range		Unit
		Min	Max	
V Limit	Maximum voltage setting for all pages	0.0	150.0/ 300.0	V
I Limit	Maximum output Irms	0.0	96.0/ 48.0	A
OCP Delay	Delay time for over current protection	0.0	9.0	Sec
Voltage Level	Output voltage range	150 V/ 300 V		
Voltage Sense	Output voltage measurement point: AC source output/ input of testing product	Voltage Sense/ Remote Sense		
Degree On	Start phase angle of output voltage	0.0	360.0	degree
Degree Off	Stop phase angle of output voltage	0.0	359.9	degree
Is Start	Delay time to start measuring output surge current	0.0	9000.0	msec
Is Interval	Duration to measure surge current	0.0	9000.0	msec
Waveform	Output waveform set at main menu	A / B		
Buzzer	Toggle switch for Buzzer	ON/ OFF		
Keylock	Lock settings at main menu	ON/ OFF		
Phase Sel.	Output mode setting	Parallel Three(SYN.) Three(INDIV) for H and J Version		

Φ2 Lead Φ1	Φ2 leads Φ1 phase angle	0.0	359.9	degree
Φ3 Lead Φ1	Φ3 leads Φ1 phase angle	0.0	359.9	degree

### Voltage Limit

To limit the maximum output voltage for all pages, It is related to Voltage Level parameter, resolution is 0.1V.

Voltage level	V Limit
300V	0.0~300.0V
150V	0.0~150.0V

It is firmware to set the limitation instead of by hardware.

Example                      The process to set Voltage Limit = 200V shows as below.

- Operation step              1. Press **▲ Up arrow** or **▼ Down arrow** key to move cursor to *V Limit*.

```

SETUP
~V Limit      : 300.0 U
I Limit       : 48.00A
OCP Delay    : 9.0 S
Voltage Level: 300V
Voltage Sense: Vout
Degree On    : 0.0
Degree Off   : 0.0
Is Start     : 0.0mS
Is Interval   : 1.0mS
Press <▶ to switch page
    
```

2. Change value to 200.0V by **numerical** key or **knob**, then press **Enter** key to confirm setting.

```

SETUP
~V Limit      : 200.0 U
I Limit       : 48.00A
OCP Delay    : 9.0 S
Voltage Level: 300V
Voltage Sense: Vout
Degree On    : 0.0
Degree Off   : 0.0
Is Start     : 0.0mS
Is Interval   : 1.0mS
Press <▶ to switch page
    
```

## I Limit, OCP Delay

I Limit represents current limit, it is used to set the maximum output current (rms). Its range is related to Voltage Level setting.

Voltage Level	I Limit
300V	0.0~48.0 A
I50V	0.0~96.0 A

OCP Delay represents over current protection (OCP) delay time. It is the delay time to shut down output voltage after output current reaches OCP point. Its range is between 0~9 seconds, resolution is 0.1 second. Both I Limit and OCP Delay are controlled by FW instead of by HW.

Operation of OCP When output current (rms) measurement is over I Limit parameter, OCP delay time start to count. If OCP last  $t$  seconds, then

- $t >$  OCP Delay parameter  $\rightarrow$  Output shuts down. Screen shows "Software OCP"
- $t <$  OCP Delay parameter  $\rightarrow$  Output continues, no protections or reports.

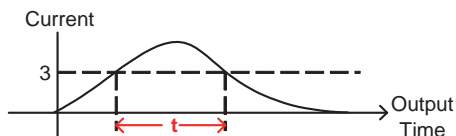

Example Set I Limit is to 3A, OCP delay time to 1.5s.

Operation step 1. Press **▲ Up arrow** or **▼ Down arrow** key to move cursor to *I Limit*.

```

SETUP
V Limit      : 200.0 V
→I Limit     : 48.00A
OCP Delay    : 9.0 S
Voltage Level: 300V
Voltage Sense: Vout
Degree On    : 0.0
Degree Off   : 0.0
Is Start     : 0.0mS
Is Interval  : 1.0mS
Press ←→ to switch page
  
```

2. Change value to 3A by **numerical** key or **knob**. Then press **Enter** key to confirm setting.

```
SETUP
V Limit      : 200.0 V
-I Limit     : 3.00A
OCP Delay    : 9.0 S
Voltage Level: 300V
Voltage Sense: Vout
Degree On    : 0.0
Degree Off   : 0.0
Is Start     : 0.0mS
Is Interval  : 1.0mS

Press ⬅➡ to switch Page
```

3. Press **▲** Up arrow or **▼** Down arrow key to move cursor to *OCP Delay*.

```
SETUP
V Limit      : 200.0 V
I Limit      : 3.00A
-OCP Delay   : 9.0 S
Voltage Level: 300V
Voltage Sense: Vout
Degree On    : 0.0
Degree Off   : 0.0
Is Start     : 0.0mS
Is Interval  : 1.0mS

Press ⬅➡ to switch Page
```

4. Change value to 1.5S by **numerical** key or **knob**. Then press **Enter** key to confirm setting.

```
SETUP
V Limit      : 200.0 V
I Limit      : 3.00A
-OCP Delay   : 1.5 S
Voltage Level: 300V
Voltage Sense: Vout
Degree On    : 0.0
Degree Off   : 0.0
Is Start     : 0.0mS
Is Interval  : 1.0mS

Press ⬅➡ to switch Page
```

## Voltage Level Setting

ASD-1900 provides two output voltage levels used for low voltage and high voltage applications. At 300V level, AC source can provide 48.0A in total ; At 150V level 96.0A in total can be provided, maximum output power is 9000VA.

When switched from 300V to 150V level, AC source will check all voltage settings, and change the setting to 150V if any voltage setting checked is higher than 150V.

When switched from 150V to 300V level, AC source will check all I Limit settings, and change the setting to 48.0A if any current setting checked is higher than 48.0A.

---

Example                      Set output voltage level to 150V

---

- Operation step      1. Press **▲ Up arrow** or **▼ Down arrow** key to move cursor to *Voltage Level*.

```

SETUP
V Limit      : 200.0 V
I Limit      : 3.00A
OCP Delay    : 1.5 S
→Voltage Level: 300V
Voltage Sense: Vout
Degree On    : 0.0
Degree Off   : 0.0
Is Start     : 0.0mS
Is Interval  : 1.0mS
Press ←→ to switch page
  
```

2. Rotate **knob** to change *Voltage Level* to 150V, then press **Enter** key to confirm setting.

```

SETUP
V Limit      : 200.0 V
I Limit      : 3.00A
OCP Delay    : 1.5 S
→Voltage Level: 150V
Voltage Sense: Vout
Degree On    : 0.0
Degree Off   : 0.0
Is Start     : 0.0mS
Is Interval  : 1.0mS
Press ←→ to switch page
  
```

## Voltage Sense

Voltage Sense determines output voltage measurement point is at AC output terminal (*Vout*) or input terminal at product under testing (*Vsense*). If it is set at *Vsense*, Remote Sense wire must be connected first, otherwise compensate error will occur. AC source will compensate the voltage drop of the output cable if *Vsense* is selected.

---

Example                      Set Voltage Sense to from *Vout* to *Vsense*.

---

- Operation step    1. Press **▲ Up arrow** or **▼ Down arrow** key to move cursor to *Voltage Sense*.

```

SETUP
V Limit      : 200.0 V
I Limit      : 3.00A
OCP Delay    : 1.5 S
Voltage Level: 150V
-Voltage Sense: Vout
Degree On    : 0.0
Degree Off   : 0.0
Is Start     : 0.0mS
Is Interval  : 1.0mS

Press ◀▶ to switch Page
  
```

2. By rotating **knob** to change parameter to *Vsense*, then press **Enter** key to confirm setting.

```

SETUP
V Limit      : 200.0 V
I Limit      : 3.00A
OCP Delay    : 1.5 S
Voltage Level: 150V
-Voltage Sense: Vsense
Degree On    : 0.0
Degree Off   : 0.0
Is Start     : 0.0mS
Is Interval  : 1.0mS

Press ◀▶ to switch Page
  
```

## Degree On, Off

ASD-1900 can control the start phase angle (Degree On) or stop phase angle (Degree Off) of the output voltage waveform. Range for Degree On is 0.0~359.9, and is 0.0~360.0 for Degree Off. When Degree Off parameter is 0, the output stopped immediately no matter which output status is at. If 0.0 degree for stop phase angle is needed, please set Degree Off to 360.0.

Example                      Set phase angle Degree On = 100 and Degree Off = 200

- Operation step            1. Press **▲ Up arrow** or **▼ Down arrow** key to move cursor to *Degree ON*.

```

SETUP
V Limit      : 200.0 V
I Limit      : 3.00A
OCP Delay    : 1.5 S
Voltage Level: 150V
Voltage Sense: Vsense
→Degree On   : 0.0
Degree Off   : 0.0
Is Start     : 0.0mS
Is Interval  : 1.0mS
Press ←→ to switch page
  
```

2. Change parameter to 100 by **numerical** key or **knob**. Then press **Enter** key to confirm setting.

```

SETUP
V Limit      : 200.0 V
I Limit      : 3.00A
OCP Delay    : 1.5 S
Voltage Level: 150V
Voltage Sense: Vsense
→Degree On   : 100.0
Degree Off   : 0.0
Is Start     : 0.0mS
Is Interval  : 1.0mS
Press ←→ to switch page
  
```

3. Press **▲ Up arrow** or **▼ Down arrow** key to move cursor to *Degree OFF*.

```

SETUP
V Limit      : 200.0 V
I Limit      : 3.00A
OCP Delay    : 1.5 S
Voltage Level: 150V
Voltage Sense: Vsense
Degree On    : 100.0
~Degree Off  : 0.0
Is Start     : 0.0mS
Is Interval  : 1.0mS
Press < > to switch Page

```

- Change parameter to 200 by **numerical** key or **knob**. Then press **Enter** key to confirm setting.

```

SETUP
V Limit      : 200.0 V
I Limit      : 3.00A
OCP Delay    : 1.5 S
Voltage Level: 150V
Voltage Sense: Vsense
Degree On    : 100.0
~Degree Off  : 200.0
Is Start     : 0.0mS
Is Interval  : 1.0mS
Press < > to switch Page

```

## Is Start, Is Interval

Both the parameter ranges for Is Start and Is Intervals are 0.0~1000.0 msec, these parameters are used for the surge current measurement.

Figure shown below indicates the measurement of the surge current starting at **Is Start** after output enabled, and measurement time is **Is Interval**.

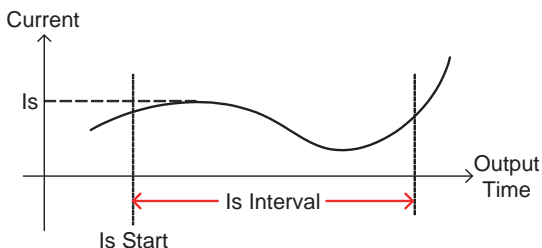

If Is Start = 500ms, Is Interval = 200ms, then Is measurement shown on main menu is the maximum current measured between 500~700ms after output enabled.



Example Set Is Start = 500ms and Is Interval = 200ms

- Operation step 1. Press **▲ Up arrow** or **▼ Down arrow** key to move cursor to *Is Start*.

```
SETUP
V Limit      : 200.0 V
I Limit      : 3.00A
OCP Delay    : 1.5 S
Voltage Level: 150V
Voltage Sense: Vsense
Degree On    : 100.0
Degree Off   : 200.0
→Is Start    : 0.0mS
Is Interval   : 1.0mS

Press ←→ to switch page
```

2. Change parameter to 500.0 by **numerical** key or **knob**. Then press **Enter** key to confirm setting.

```
SETUP
V Limit      : 200.0 V
I Limit      : 3.00A
OCP Delay    : 1.5 S
Voltage Level: 150V
Voltage Sense: Vsense
Degree On    : 100.0
Degree Off   : 200.0
→Is Start    : 500.0mS
Is Interval   : 1.0mS

Press ←→ to switch page
```

3. Press **▲ Up arrow** or **▼ Down arrow** key to move cursor to *Is Interval*.

```
SETUP
V Limit      : 200.0 V
I Limit      : 3.00A
OCP Delay    : 1.5 S
Voltage Level: 150V
Voltage Sense: Vsense
Degree On    : 100.0
Degree Off   : 200.0
Is Start      : 500.0mS
→Is Interval  : 1.0mS

Press ←→ to switch page
```

4. Change parameter to 200 by **numerical** key or **knob**. Then press **Enter** key to confirm setting.

```
SETUP
V Limit      : 200.0 V
I Limit      : 3.00A
OCP Delay    : 1.5 S
Voltage Level: 150V
Voltage Sense: Vsense
Degree On    : 100.0
Degree Off   : 200.0
Is Start     : 500.0mS
→Is Interval : 200.0mS
Press ◀▶ to switch page
```

## Waveform Selection

ASD-1900 provides two sets built in waveforms A and B. User can select Sin, CSin, Squa or other self-defined waveform from A or B set at CONFIG page, then go to SETUP page to set output voltage waveform for main menu.

Example Set waveform from A to B

### Operation step

- 1.
2. Press **▲ Up arrow** or **▼ Down arrow** key to move cursor to *Waveform*.

```

SETUP
→Waveform :A
  Buzzer   :ON
  KeyLock  :OFF
  Phase Sel.:Three(SYN.)

OUT MODE  -Three Phase
φ2 Lead φ1:120.0
φ3 Lead φ1:240.0

Press ←→ to switch page
  
```

3. Rotate **knob** to change A to B, then press **Enter** key to confirm setting.

```

SETUP
→Waveform :B
  Buzzer   :ON
  KeyLock  :OFF
  Phase Sel.:Three(SYN.)

OUT MODE  -Three Phase
φ2 Lead φ1:120.0
φ3 Lead φ1:240.0

Press ←→ to switch page
  
```



Note

Press **OUT** key when main menu appears, only A or B can be selected. If using LIST function, then A or B waveform can be output alternatively.



## Buzzer

When user press numerical key or rotate knob, there is sound from buzzer to confirm the operation, it can be muted if the confirmation is not needed.

---

Example                      Mute the buzzer

---

- Operation Step      1. Press  **Up arrow** or  **Down arrow** key to move cursor to *Buzzer*.

```

SETUP
Waveform   :B
-Buzzer    :ON
Keylock    :OFF
Phase Sel. :Three(SYN.)

OUT MODE   -Three Phase
φ2 Lead φ1:120.0
φ3 Lead φ1:240.0

Press ←→ to switch page
  
```

2. Rotate **knob** to change *ON* to *OFF*, then press **Enter** key to confirm setting.

```

SETUP
Waveform   :B
-Buzzer    :OFF
Keylock    :OFF
Phase Sel. :Three(SYN.)

OUT MODE   -Three Phase
φ2 Lead φ1:120.0
φ3 Lead φ1:240.0

Press ←→ to switch page
  
```

## Disable (Lock) the Keys at Front Panel

ASD-1900 allows the user to lock the parameters at front panel to avoid being changed accidentally. After the parameters are locked, only **Menu/ Home** key and **OUT** key are enabled. **Menu/ Home** key allows user to return to SETUP menu to enable or disable lock. **OUT** key enables or disables the output.

Example                      Set keys on front panel from OFF to ON.

- Operation Step      1. Press **▲ Up arrow** or **▼ Down arrow** key to move cursor to *Keylock*.

```

SETUP
Waveform   :B
Buzzer     :OFF
→Keylock   :OFF
Phase Sel. :Three(SYN.)

OUT MODE   -Three Phase
φ2 Lead φ1:120.0
φ3 Lead φ1:240.0

Press ←→ to switch page
  
```

2. Rotate **knob** to change *OFF* to *ON*, then press **Enter** key to confirm setting.

```

SETUP
Waveform   :B
Buzzer     :OFF
→Keylock   :ON
Phase Sel. :Three(SYN.)

OUT MODE   -Three Phase
φ2 Lead φ1:120.0
φ3 Lead φ1:240.0

Press ←→ to switch page
  
```

## Set Single / Three Phase Mode

The ASD-1900 provides three output modes.

- Single: Single phase mode
- Three(SYN.): Three phase mode. Same voltage settings applies to three phases
- Three(INDIV): Three phase mode. Voltage for three phase can be set independently.

**Example** Rotate knob to set this parameter, then press **Enter** key to confirm, about 800msec is needed to do the change. The process to change Three(SYN.) to Single demonstrates as below.

**Operation Step** 1. Press **▲ Up arrow** or **▼ Down arrow** key to move cursor to *Phase Sel.*

```

SETUP
Waveform :A
Buzzer :ON
Keylock :OFF
→Phase Sel.:Three(SYN.)

OUT MODE -Three Phase
φ2 Lead φ1:120.0
φ3 Lead φ1:240.0

Press ←→ to switch page
  
```

2. Rotate knob to change parameter to *Single*, then press **Enter** key to confirm.

```

SETUP
Waveform :B
Buzzer :OFF
Keylock :ON
→Phase Sel.:Single

Press ←→ to switch page
  
```

3. Press **Menu/ Home** key to return to main menu, "Single Phase" can be found on the top right of the main menu, the contents for the Meter Report also changed at bottom of the main menu.

SET MODE	Single Phase
→V : 110.0	F : 60.0
Meter Report	
V : 0.0	I : 0.00
VA : 0.0	IP : 0.00
VAR: 0.0	IS : 0.00
F : 0.0	CF : 0.000
P : 0.0	PF : 0.000

At Three (SYN.) mode, voltage and frequency are same for three phases. When switched from Three (SYN.) to Three(INDIV) mode,  $V\Phi 1\sim 3$  and  $F\Phi 1\sim 3$  will be same as that at Three(SYN.) mode.

**Example** Factory setting is Three(SYN.) mode, voltage and frequency is 110.0 and 60.0 ; if changes voltage to  $V=300.0$ , frequency to  $F=1000.0$ , then follow steps 1 ~ 2 to change output mode to Three(INDIV), main menu page will change and show as below.

SET MODE	Three(INDIV)
→V $\Phi 1$ : 300.0	F $\Phi 1$ : 1000.00
V $\Phi 2$ : 300.0	F $\Phi 2$ : 1000.00
V $\Phi 3$ : 300.0	F $\Phi 3$ : 1000.00
Meter Report: (Overview)	
V $\Phi 1$ : 0.0	I $\Phi 1$ : 0.00
V $\Phi 2$ : 0.0	I $\Phi 2$ : 0.00
V $\Phi 3$ : 0.0	I $\Phi 3$ : 0.00
P $\Phi 1$ : 0.0	$\Sigma I$ : 0.00
P $\Phi 2$ : 0.0	$\Sigma P$ : 0.0
P $\Phi 3$ : 0.0	$\Sigma PF$ : 0.000

When changes from Three(INDIV) mode to Three(SYN.) mode, V and F at Three(SYN.) are same as  $V\Phi 1$  and  $F\Phi 1$ .

**Example** At Three(INDIV) mode, set  $V\Phi 1$  as 220 shows as below.

SET MODE	Three(INDIV)
→V $\Phi 1$ : 220.0	F $\Phi 1$ : 1000.00
V $\Phi 2$ : 300.0	F $\Phi 2$ : 1000.00
V $\Phi 3$ : 300.0	F $\Phi 3$ : 1000.00
Meter Report: (Overview)	
V $\Phi 1$ : 0.0	I $\Phi 1$ : 0.00
V $\Phi 2$ : 0.0	I $\Phi 2$ : 0.00
V $\Phi 3$ : 0.0	I $\Phi 3$ : 0.00
P $\Phi 1$ : 0.0	$\Sigma I$ : 0.00
P $\Phi 2$ : 0.0	$\Sigma P$ : 0.0
P $\Phi 3$ : 0.0	$\Sigma PF$ : 0.000

Follow previous steps 1 ~ 2 to change output mode to Three(SYN.), main manual page will show as below

```

SET MODE      Three(SYN.)
→V : 220.0   F : 50.0

Meter Report:(Overview)
Vφ1: 0.0   Iφ1: 0.00
Vφ2: 0.0   Iφ2: 0.00
Vφ3: 0.0   Iφ3: 0.00
Pφ1: 0.0   ΣI : 0.00
Pφ2: 0.0   ΣP : 0.0
Pφ3: 0.0   ΣPF: 0.000

```

## Set Phase Shift for Three Phase Mode

The ASD-1900 allows user to set phase shift for three phase mode. Phase shift parameters will show up when Phase Sel. Parameter set as Three(SYN.) or Three(INDIV). Make  $\Phi$  1 as reference, default settings are

- $\Phi$ 2 leads  $\Phi$ 1 120 °
- $\Phi$ 3 leads  $\Phi$ 1 240 °

**Example** Set phase shift  $\Phi$ 2 leads  $\Phi$ 1 100°,  $\Phi$ 3 leads  $\Phi$ 1 100° show as below

**Operation Step** 1. Press **▲ Up arrow** or **▼ Down arrow** key to move cursor to  $\Phi$ 2 Lead  $\Phi$ 1

```

SETUP
Waveform :B
Buzzer :OFF
Keylock :ON
Phase Sel.:Three(SYN.)

OUT MODE -Three Phase
→φ2 Lead φ1:120.0
φ3 Lead φ1:240.0

Press ← to switch Page

```

2. Change parameter to 100 by **numerical** key or **knob**. Then press **Enter** key to confirm setting.

```

SETUP
Waveform :B
Buzzer :OFF
Keylock :ON
Phase Sel.:Three(SYN.)

OUT MODE -Three Phase
→φ2 Lead φ1:100.0
φ3 Lead φ1:240.0

Press ← to switch Page

```



3. Press **▲ Up arrow** or **▼ Down arrow** key to move cursor to  $\Phi 3$  Lead  $\Phi 1$

```
SETUP
Waveform  :B
Buzzer    :OFF
KeyLock   :ON
Phase Sel.:Three(SYN.)

OUT MODE  -Three Phase
 $\Phi 2$  Lead  $\Phi 1$ :100.0
 $\rightarrow \Phi 3$  Lead  $\Phi 1$ :240.0

Press  $\leftrightarrow$  to switch page
```

4. Change parameter to 200 by **numerical** key or **knob**. Then press **Enter** key to confirm setting.

```
SETUP
Waveform  :B
Buzzer    :OFF
KeyLock   :ON
Phase Sel.:Three(SYN.)

OUT MODE  -Three Phase
 $\Phi 2$  Lead  $\Phi 1$ :100.0
 $\rightarrow \Phi 3$  Lead  $\Phi 1$ :200.0

Press  $\leftrightarrow$  to switch page
```

## CONFIG Function

- Operation step
1. Press **numerical** key **2** on the front panel to select *CONFIG* option when the advanced parameter setting menu appears.

```
PAGE SELECT:2
1. SETUP
2. CONFIG
3. LIST
4. PULSE
5. STEP
6. SYNTHESIS
```

2. Press **Enter** key to enter CONFIG setting menu shown as figure below.

```
CONFIG
->Wave A :SIN
Wave B :SIN
GPIB ADDR:30
RS232 BaudRate:9600
RS232 Parity :NONE
Remote Inhibit:OFF

Power On State
Output :OFF
Phase Sel.:Three(SYN.)
```

### Definitions for all parameters on CONFIG setting menu

Parameter	Definition	Setting Range	
		Minimum	Maximum
Wave A	Stored group A waveform	Sin, CSin, DST0 ~ DST31	
Wave B	Stored group B waveform	DST31	
GPIB ADDR	Address of GPIB	1	30
RS232 Baud Rate	Baud Rate of RS232	9600/ 19200	
RS232 Parity	RS232 Odd/Even parity check	NONE, EVEN, ODD	
Remote Inhibit	External TTL signal to control output	OFF, LIVE, TRIG, EXCITE	

Output	Output status for next time after AC on	ON/ OFF
Phase Sel.	Output mode for next time after AC on	Single Phase Three(SYN.) Three(INDIV) for H & J version

## Waveform A, B Generator

ASD-1900 provides memories to store group A and B waveforms, both A and B groups have waveforms as below

Waveforms	<ul style="list-style-type: none"> <li>• Sinusoidal (Sine)</li> <li>• Cut sinusoidal (Cut Sine)</li> <li>• 30 sets built in waveforms (DST0~DST29). See appendix “<b>Built In Waveforms</b>” on page 137 for details.</li> <li>• 2 sets user defined waveforms(DST30~DST31)</li> </ul>
-----------	--

Example	The processes to set group A waveform as built in waveform number 20
---------	--

Operation step	1. Press <b>▲ Up arrow</b> or <b>▼ Down arrow</b> key to move cursor to <i>Wave A</i> .
----------------	---

```

CONFIG
→Wave A :SIN
Wave B :SIN
GPIB ADDR:30
RS232 BaudRate:9600
RS232 Parity :NONE
Remote Inhibit:OFF

Power On State
Output :OFF
Phase Sel.:Three(SYN.)

```

2. Rotate **Knob** to change *SIN* to *DST20*. Then press **Enter** key to confirm setting.

```

CONFIG
->Wave A :DST20
Wave B :SIN
GP1B ADDR:30
RS232 BaudRate:9600
RS232 Parity :NONE
Remote Inhibit:OFF

Power On State
Output :OFF
Phase Sel.:Three(SYN.)

```

**Example** The processes to set group B waveform as cut sinusoidal waveform (Cut Sine) with CF 1.300.

**Operation step** 1. Press **▲ Up arrow** or **▼ Down arrow** key to move cursor to *Wave B*.

```

CONFIG
->Wave A :DST20
->Wave B :SIN
GP1B ADDR:30
RS232 BaudRate:9600
RS232 Parity :NONE
Remote Inhibit:OFF

Power On State
Output :OFF
Phase Sel.:Three(SYN.)

```

2. Rotate **Knob** to change *SIN* to *CSIN*. Press **Enter** key to confirm setting. CS parameter appears when <CSIN> selected.

```

CONFIG
Wave A :DST20
->Wave B :CSIN CF:1.200
GP1B ADDR:30
RS232 BaudRate:9600
RS232 Parity :NONE
Remote Inhibit:OFF

Power On State
Output :OFF
Phase Sel.:Three(SYN.)

```

3. Press **▲ Up arrow** or **▼ Down arrow** key to move cursor to *CSIN CF*.

```

CONFIG
Wave A :DST20
Wave B :CSIN →CF:1.200
GPIB ADDR:30
RS232 BaudRate:9600
RS232 Parity :NONE
Remote Inhibit:OFF

Power On State
Output :OFF
Phase Sel.:Three(SYN.)
    
```

4. Change parameter to 1.300 by using **numerical** key or **knob**. Then press **Enter** key to confirm setting.

```

CONFIG
Wave A :DST20
Wave B :CSIN →CF:1.300
GPIB ADDR:30
RS232 BaudRate:9600
RS232 Parity :NONE
Remote Inhibit:OFF

Power On State
Output :
Phase Sel.:Three(SYN.)
    
```

### GPIB, RS232 Communication Setting

ASD-1900 provides remote control operation, there are GPIB or RS232 interface for selection. Only one interface can be activated at the same time.

Controller \ Operation Mode	Menu (front panel)	Remote (GPIB)	Remote (RS232)
Menu (front panel)	<input type="radio"/>	<input checked="" type="checkbox"/>	<input checked="" type="checkbox"/>
Remote (GPIB)	<input checked="" type="checkbox"/>	<input type="radio"/>	<input checked="" type="checkbox"/>
Remote (RS232)	<input checked="" type="checkbox"/>	<input checked="" type="checkbox"/>	<input type="radio"/>

Switch menu to remote control

Send any command to AC source directly, AC source enter remote control mode automatically.

### Switch from remote to local control

- Methods
- Stop remote control, press **- / Unlock** key longer than 2 seconds until "SET MODE" shown on upper left on the screen.
  - Send \*CLS command.

### Switch remote control between GPIB or RS232

Return to menu operation as demonstrated above, then use another communication interface to do the control.

### Parameters setting for two interfaces

GPIB	RS232
Address	Odd/Even parity check(Parity) Baud rate (Baud Rate)
<ul style="list-style-type: none"> <li>• 1-30</li> </ul>	<ul style="list-style-type: none"> <li>• Even parity check (EVEN)</li> <li>• Odd parity check (ODD)</li> <li>• No parity check (NONE)</li> </ul>

Example Set GPIB address to 20

- Operation step
1. Press **▲ Up arrow** or **▼ Down arrow** key to move cursor to *GPIB ADDR*.

```

CONFIG
Wave A :DST20
Wave B :CSIN CF:1.300
->GPIB ADDR:30
RS232 BaudRate:9600
RS232 Parity :NONE
Remote Inhibit:OFF

Power On State
Output :OFF
Phase Sel.:Three(SYN.)
    
```

2. Change parameter to 20 by using **numerical** key or **knob**. Then press **Enter** key to confirm setting.

```

CONFIG
Wave A   :DST20
Wave B   :CSIN  CF:1.300
→ GPIB ADDR:20
RS232 BaudRate:9600
RS232 Parity :NONE
Remote Inhibit:OFF

Power On State
Output       :OFF
Phase Sel.  :Three(SYN.)

```





Note

The range of address is 1-30.

Example

The processes to set RS232 Baud rate = 19200,  
Odd/Even parity check = (ODD)

Operation step

1. Press  **Up arrow** or  **Down arrow** key to move cursor to *RS232 Baud Rate*.

```

CONFIG
Wave A   :DST20
Wave B   :CSIN  CF:1.300
GPIB ADDR:20
→RS232 BaudRate:9600
RS232 Parity :NONE
Remote Inhibit:OFF

Power On State
Output       :OFF
Phase Sel.  :Three(SYN.)

```



2. Rotate **Knob** to change parameter value from 9600 to 19200. The press  **Enter** key to confirm setting.

```

CONFIG
Wave A   :DST20
Wave B   :CSIN  CF:1.300
GPIB ADDR:20
→RS232 BaudRate:19200
RS232 Parity :NONE
Remote Inhibit:OFF

Power On State
Output       :OFF
Phase Sel.  :Three(SYN.)

```

3. Press  **Up arrow** or  **Down arrow** key to move cursor to *RS232 Parity*.

```

CONFIG
Wave A :DST20
Wave B :CSIN CF:1.300
GP1B ADDR:20
RS232 BaudRate:19200
→RS232 Parity :NONE
Remote Inhibit:OFF

Power On State
Output :OFF
Phase Sel.:Three(SYN.)

```

4. Rotate **Knob** to change parameter from *NONE* to *ODD*. Then press **Enter** key to confirm setting.

```

CONFIG
Wave A :DST20
Wave B :CSIN CF:1.300
GP1B ADDR:20
RS232 BaudRate:19200
→RS232 Parity :ODD
Remote Inhibit:OFF

Power On State
Output :OFF
Phase Sel.:Three(SYN.)

```

### Inhibit Output by Remote Control Signal (Remote Inhibit)

Remote Inhibit is an “Active HIGH” TTL signal, high level is 5V, low level is 0V. Its signals send to 9 pin TTL signal connector (D-SUB) at back panel of the AC source. Please refer to appendix “**TTL Pin Assignment**” on page 137 for details.

After Remote Inhibit initialized, output control priorities for AC source are as below

---

Front panel > TTL signal  
Remote Control

- When both front panel and remote control are idle, output of ASD-1900 is according to external TTL ON/OFF signal.
- When user press **OUT** key from front panel or by remote control, TTL signal has no effect on the operation.



There are four Remote inhibit output status.

- OFF: Turn off remote inhibit function.
- LIVE: two conditions

TTL signal changes from HIGH to LOW, and stays low longer than 1ms, ASD-1900 turn off output.

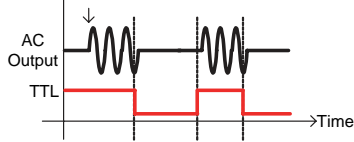

TTL signal changes from LOW to HIGH, and stays high longer than 1ms, ASD-1900 resume output.

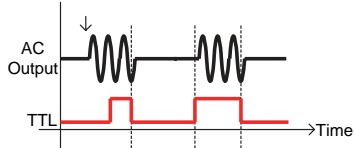

- TRIG: TTL signal changes from HIGH to LOW, and keeps low longer than 1ms, ASD-1900 turn off output, and stop detecting TTL signal, output stays at off state even TTL signal changes to high. User must press **OUT** key to resume output and enable TTL signal detecting.
- EXCITE: When user is using LIST, PULSE or STEP modes, output ON/OFF of ASD-1900 can be triggered by rising edge of TTL signal (LOW to HIGH) at trigger page (please refer to section **LIST Mode** until **STEP Mode** on page 70 for details). The pulse signal must keep at least 1ms when the signal changes.

When output of AC source is at off state, it will be triggered to on state if TTL signal changes from LOW to HIGH. There will be two conditions introduced as below.

- If output sequences finishes and TTL signal changes from LOW to HIGH again, the output will be triggered to on state and repeat the sequences again.
- If TTL signal changes from LOW to HIGH when output sequences are not finished yet, output will turn off.

**Example** The processes to change Remote Inhibit setting from *OFF* to *TRIG*.

- Operation step**
1. Press **▲ Up arrow** or **▼ Down arrow** key to move cursor to *Remote Inhibit*.

```
CONFIG
Wave A :DST20
Wave B :CSIN CF:1.300
GP1B ADDR:20
RS232 BaudRate:19200
RS232 Parity :ODD
-Remote Inhibit:OFF

Power On State
Output :OFF
Phase Sel.:Three(SYN.)
```

2. Rotate **Knob** to change parameter value from *OFF* to *TRIG*. Then press **Enter** key to confirm setting.

```
CONFIG
Wave A :DST20
Wave B :CSIN CF:1.300
GP1B ADDR:20
RS232 BaudRate:19200
RS232 Parity :ODD
-Remote Inhibit:TRIG

Power On State
Output :OFF
Phase Sel.:Three(SYN.)
```

## Power On State

The ASD-1900 may set different operation modes or enable turn on output immediately next time after AC is on. Output voltage and frequency depend on stored parameter before AC input is off.

**Please refer chapter 5 how for to save current parameter's setting.**

**Example** The process to set output is ON, operation mode is Single for next time after AC is on.

**Operation step** 1. Press **▲ Up arrow** or **▼ Down arrow** key to move cursor to *Output*.

```
CONFIG
Wave A   :DST20
Wave B   :CSIN  CF:1.300
GPIB ADDR:20
RS232 BaudRate:19200
RS232 Parity :ODD
Remote Inhibit:TRIG

Power On State
→Output   :OFF
Phase Sel.:Three(SYN.)
```

2. Rotate **Knob** to change parameter value from *OFF* to *ON*. Then press **Enter** key to confirm setting.

```
CONFIG
Wave A   :DST20
Wave B   :CSIN  CF:1.300
GPIB ADDR:20
RS232 BaudRate:19200
RS232 Parity :ODD
Remote Inhibit:TRIG

Power On State
→Output   :ON
Phase Sel.:Three(SYN.)
```

3. Press **▲ Up arrow** or **▼ Down arrow** key to move cursor to *Phase Sel.*

```
CONFIG
Wave A :DST20
Wave B :CSIN CF:1.300
GP1B ADDR:20
RS232 BaudRate:19200
RS232 Parity :ODD
Remote Inhibit:TRIG

Power On State
Output :ON
→Phase Sel.:Three(SYN.)
```

4. By pressing numeric key or rotating knob to change parameter to *Single*. Then press **Enter** key to confirm setting.

```
CONFIG
Wave A :DST20
Wave B :CSIN CF:1.300
GP1B ADDR:20
RS232 BaudRate:19200
RS232 Parity :ODD
Remote Inhibit:TRIG

Power On State
Output :ON
→Phase Sel.:Single
```

# AAPPLICATION

ASD-1900 provides not only stable AC voltage but also three kinds of programmable dynamic output. Following paragraphs explain the definition of parameters and how to do the setting.

---

LIST Mode .....	70
Definitions for all parameters on LIST setting menu .....	71
PULSE Mode.....	75
Definitions for all parameters on PULSE setting menu.....	75
STEP Mode .....	78
Definitions for all parameters on STEP setting menu.....	78
SYNTHESIS Self-Defined Waveform Mode .....	81
Definitions for all parameters on STEP setting menu.....	82

## LIST Mode

Let user to set 10 sets of user-defined voltage, frequency. This mode can make 10 different outputs consecutively.

- Operation step
1. Press **numerical** key **3** on the front panel to select *LIST* option when the advanced parameter setting menu appears.

```
PAGE SELECT:3
1. SETUP
2. CONFIG
3. LIST
4. PULSE
5. STEP
6. SYNTHESIS
```

2. Press **Enter** key to enter LIST setting menu shown as figure below.

```
LIST
->Count: 1
Go to Trigger Mode

Press <> to switch page
```

3. Press **Page down** key to move to next page.

```
LIST
SEQ - 0
+V Start : 100.0V
V End : 50.0V
F Start : 100.0Hz
F End : 50.0Hz
Time : 1 ms
Waveform : A
Degrab On: 0.0

Press <> to switch page
```

4. Press **Page up** key to return to previous page.

```

LIST
→Count: 1
Go to Trigger Mode

Press ◀▶ to switch page

```

LIST mode provides 10 sets of programmable waveform (SEQ-0 ~ SEQ-9). Output waveforms start from SEQ-0, then SEQ-1, SEQ-2... in orders until time parameter (Time) of SEQ-n being processed is 0 or SEQ-9 is finished outputting, then one List waveform output is completed.

### Definitions for all parameters on LIST setting menu

Parameter	Definition	Setting Range	
		Min.	Max.
Count	Execution times for one complete List waveform. When 0 is setting, output recycles endless until user presses <b>Enter</b> key to stop.	0	10000
V Start	Start voltage(V)	0.0	300.0
V End	Stop voltage(V)	0.0	300.0
F Start	Start frequency(Hz)	30.0	1000.0
F End	Stop Frequency(Hz)	30.0	1000.0
Time	Output duration (msec)	0	60000
Waveform	Output waveform selection	A or B	
Degree On	Start phase angle for output waveform (deg)	0.0	359.9

- Operation step
- After SEQ setting is completed, press **ESC/Cancel** key to return to LIST mode initialization page as below.

```
LIST
Count: 1
-Go to Trigger Mode

Press <▶> to switch Page
```

- Press **Enter** key to enter Trigger setting page shown as below.

```
LIST
-Trigger ON/OFF:OFF
Output Status :Stop

Meter Report:(Overview)
Uφ1: 0.0 Iφ1: 0.00
Uφ2: 0.0 Iφ2: 0.00
Uφ3: 0.0 Iφ3: 0.00
Pφ1: 0.0 ΣI : 0.00
Pφ2: 0.0 ΣP : 0.0
Pφ3: 0.0
```

Trigger ON/ OFF is output switch for List waveform, output status is current output status.

At this page, there are two modes.

1. To output List waveform
  - Press **Enter** key to start output List waveform. Screen will show information as below during output is in process.

```
LIST
-Trigger ON/OFF:ON
Output Status :Running

Meter Report:(Overview)
Uφ1: 202.6 Iφ1: 0.00
Uφ2: 202.2 Iφ2: 0.00
Uφ3: 202.9 Iφ3: 0.00
Pφ1: 0.0 ΣI : 0.00
Pφ2: 0.0 ΣP : 0.0
Pφ3: 0.0
```

At this moment, there are three outcomes depend on user input or process status.

- Press **OUT**, **ESC/Cancel** key will stop output and stay at Trigger page.
- Press **Menu/Home** key will stop output and return to main menu.



- Output will stop when List waveform output is completed and stay at Trigger page.
2. To output voltage set at main menu
- Press **OUT** key will start output waveform set at main menu. Screen will show information as below during output is in process.

```

LIST
→Trigger ON/OFF:OFF
Output Status :Running

Meter Report:(Overview)
-----
Vφ1: 202.6  Iφ1:  0.00
Vφ2: 202.2  Iφ2:  0.00
Vφ3: 202.9  Iφ3:  0.00
Pφ1:   0.0  ΣI :  0.00
Pφ2:   0.0  ΣP :  0.0
Pφ3:   0.0

```

At this moment, there are three outcomes depend on user input or process status.

- Press **OUT**, **ESC/Cancel** key will stop output and stay at Trigger page.
- Press **Menu/Home** key will stop output and return to main menu.
- Press **Enter** key will output waveform programmed in LIST mode.

There are two ways to leave Trigger page

- Under output is off, press **ESC/Cancel** key will return to LIST initialization page.
- Press **Menu/Home** key return to main menu.

Example:  
Parameter setting

```

LIST
→Count:  1
Go to Trigger Mode

Press ◀▶ to switch page

```

```
LIST
SEQ - 0
-V Start : 40.0V
V End : 110.0V
F Start : 50.0Hz
F End : 50.0Hz
Time : 72 mS
Waveform : A
Degree On: 45.0

Press <▶> to switch Page
```

```
LIST
SEQ - 01
-Vs : 80.0V
Ve : 150.0V
Fs : 100.0Hz
Fe : 200.0Hz
Time : 100 mS
Waveform : A
Degree On: 45.0

Press <▶> to switch Page
```

Output waveform

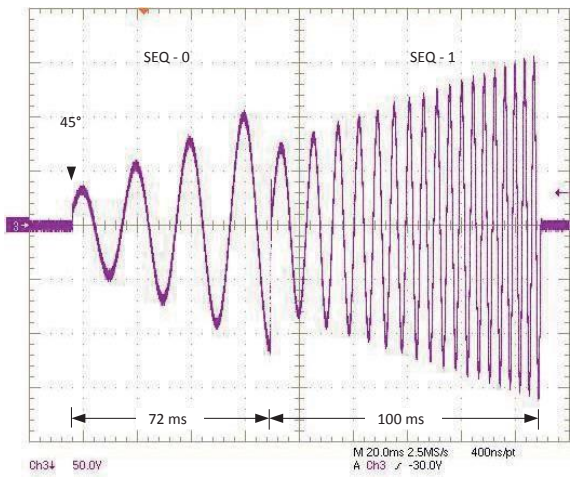

## PULSE Mode

Simulate repeatedly changed output voltage.

- Operation step 1. Press **numerical** key **4** on the front panel to select *PULSE* option when the advanced parameter setting menu appears.

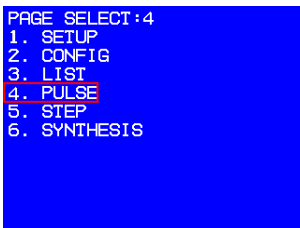

2. Press **Enter** key to enter PULSE setting menu shown as figure below.

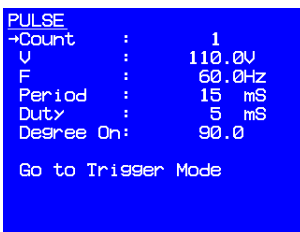

PULSE mode lets user insert fixed period, programmed special waveform to output waveform set at main menu.

### Definitions for all parameters on PULSE setting menu

Parameter	Definition	Setting Range	
		Min.	Max.
Count	How many times to output programmed Pulse waveform. If setting is 0, Pulse waveform will output endless until <b>Enter</b> key is pressed	0	10000
Vac	Voltage of Pulse:	0.0	300.0

F	Frequency of Pulse	30.0	1000.0
Period	Duration of total period	2	60000
Duty	Duration time of Pulse, its value can't be greater than the Period.	1	59999
Degree On	Start phase angle of Pulse output	0.0	359.9

- Operation step
- Select Go to Trigger Mode, press **Enter** key to do the setting. Screen shows information as below at trigger page.

```

PULSE
->Trigger ON/OFF:OFF
Output Status :Stop

Meter Report:(Overview)
Vφ1: 0.0 Iφ1: 0.00
Vφ2: 0.0 Iφ2: 0.00
Vφ3: 0.0 Iφ3: 0.00
Pφ1: 0.0 ΣI : 0.00
Pφ2: 0.0 ΣP : 0.0
Pφ3: 0.0
    
```

- Trigger ON/OFF is switch to control on/off of programmed Pulse waveform, Output Status is current status. Operation procedures on this page is same as that explained on page 72.

Example for  
PULSE output  
Parameter setting

```

PULSE
->Count : 0
V : 150.0V
F : 60.0Hz
Period : 100 mS
Duty : 40 mS
Degree On: 90

Go to Trigger Mode
    
```

Output waveform

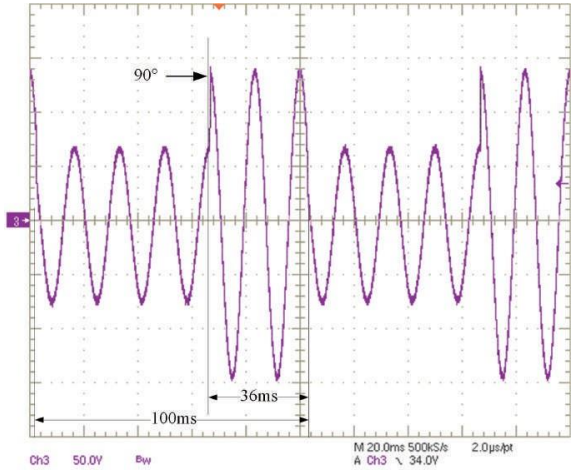

## STEP Mode

Simulate gradually changed output voltage.

- Operation step
1. Press **numerical** key **5** on the front panel to select *STEP* option when the advanced parameter setting menu appears.

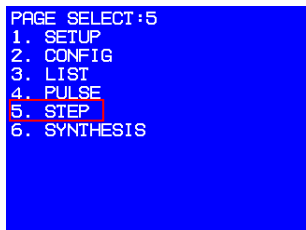

2. Press **Enter** key to enter STEP setting menu shown as figure below.

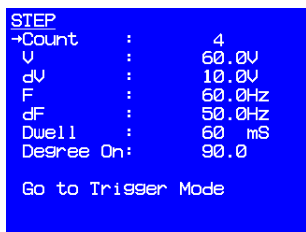

Voltage and frequency are same for each step in STEP mode, but may be different in different steps.

### Definitions for all parameters on STEP setting menu

Parameter	Definition	Setting Range	
		Min.	Max.
Count	How many steps	0	10000
V	Voltage amplitude at first step.	0.0	300.0
dV	Voltage amplitude change for each step. May be positive or negative	-150.0	150.0
F	Start frequency at first step	30.0	1000.0

dF	Frequency change for each step. May be positive or negative	-150.0	150.0
Dwell	Output duration for each step	1	60000
Degree On	Initial phase angle for each STEP	0.0	359.9

For each STEP, voltage waveform changes satisfy following equation.

- $V_t = V_{t-1} + dV$   
Voltage amplitude of next STEP =current voltage amplitude + STEP amplitude change.
- $F_t = F_{t-1} + dF$   
Voltage frequency of next STEP =current voltage frequency + STEP frequency change.

- Operation step
- Select Go to Trigger Mode, press **Enter** key to enter Trigger page shown as below.

```
STEP
→Trigger ON/OFF:OFF
Output Status :Stop

Meter Report:(Overview)
Vφ1: 0.0 Iφ1: 0.00
Vφ2: 0.0 Iφ2: 0.00
Vφ3: 0.0 Iφ3: 0.00
Pφ1: 0.0 ΣI : 0.00
Pφ2: 0.0 ΣP : 0.0
Pφ3: 0.0
```

- Trigger ON/OFF is switch to turn on/off of Step output. Output Status is current status. Operation on this page is same as that on page 72.

Example of Step mode  
Parameter setting

```
STEP
→Count : 4
V : 60.0V
dV : 10.0V
F : 60.0Hz
dF : 50.0Hz
Dwell : 60 mS
Degree On: 90.0

Go to Trigger Mode
```

Output waveform

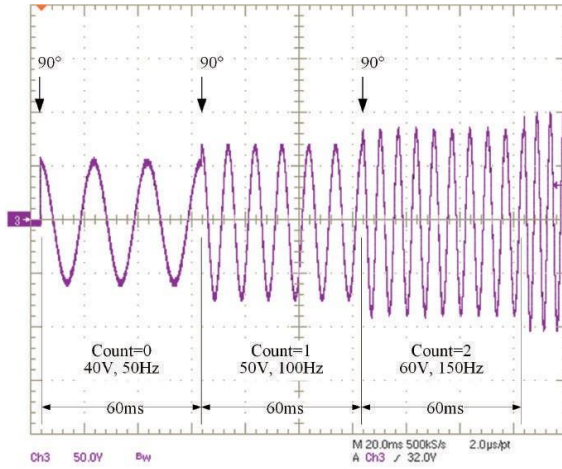



## SYNTHESIS Self-Defined Waveform Mode

ASD-1900 also provides 39 orders of amplitude and phase angle settings for user to make self-defined waveforms. It can be used at all output modes once the self-defined waveforms are created.

- Operation step
1. Press **numerical** key **6** on the front panel to select *STEP* option when the advanced parameter setting menu appears.

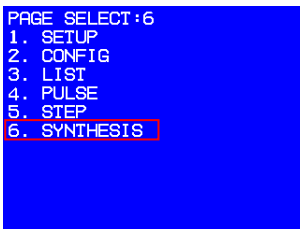

2. Press **Enter** key to enter SYNTHESIS setting menu shown as figure below.

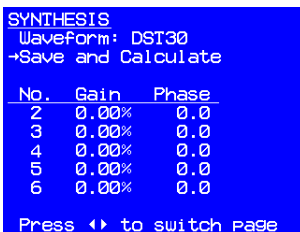

In SYNTHESIS self-defined waveform mode, voltage and frequency of fundamental waveform is sinusoidal defined at main menu. User can edit amplitude and phase angle of harmonic waveform up to 39 order of fundamental wave. Editing can be done by front panel or remote control.

Definitions for all parameters on STEP setting menu

Parameter	Definition	Setting Range	
		Min.	Max.
Waveform	Name for two sets of SYNTHESIS waveform	DST30/ DST31	
Gain	Voltage amplitude ratio of Harmonic to fundamental wave for each order.	Order 2~20	
		0	33.33
		Order 21~30	
		0	30.00
Phase	Start phase angle of harmonic wave for each order	Order 31~39	
		0	15.00
Phase	Start phase angle of harmonic wave for each order	0	359.9

- Operation step
- Press **Page down** key to move cursor to Gain and Phase parameter setting area to setting.

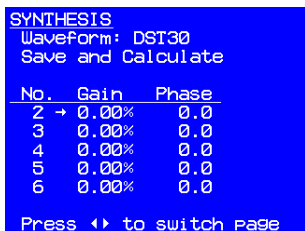

- When parameters for all orders are set, Press **Page up** key or **ESC/Cancel** key to return to the initial page of SYNTHESIS.
- Press **Down arrow** key to move cursor to "Save Synthesis Parameter"
- Press **Enter** key to calculate and save the synthesized waveform to EEPROM. Screen shows as bow.

Save Data to EEPROM  
and  
Calculate Synthesis  
.....

It takes about 8 seconds to do the calculation and saving. It will return to first page of SYNTHESIS when saving is completed. For protection purpose, amplitude for each order must not exceed limitation as below.

Orders	Gain limit
2~20	33.33%
21~30	30.00%
31~39	15.00%

Example of SYNTHESIS mode.

Orders	Gain	Phase
2	2.07	0.0
5	9.80	0.0
7	15.80	0.0
8	2.16	0.0

Output waveform

$$\left[ \begin{array}{l} n(w) + \\ 2.07 \times n(2w + 0.0) + \\ 9.80 \times n(5w + 0.0) + \\ 15.80 \times n(7w + 0.0) + \\ 2.16 \times n(8w + 0.0) \end{array} \right]$$

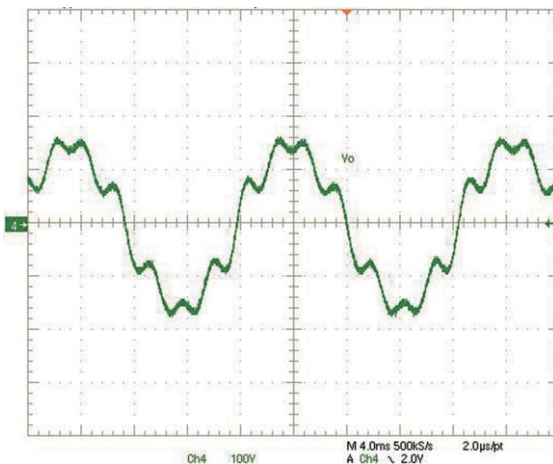

# SAVE AND RECALL

ASD-1900 provides two modes for users to save and recall the output setting or the system information.

---

System parameter Save and Recall.....	85
Save the main page setting.....	85
Recall the main page setting.....	86

## System parameter Save and Recall

The ASD-1900 provides 4 set of memories for user to save and recall modified system information. User can back to default system setting easily any time by selecting default setting.

### Save the main page setting

How to save current system settings to first memory No.1.

---

- Operation step
1. At advanced parameters setting manual, long press **▲ Save** key for two seconds will enter system data save page as below.

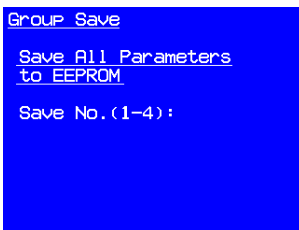

```
Group Save
Save All Parameters
to EEPROM
Save No. (1-4) :
```

2. Change save No. (1-4) to 1 by pressing numerical key or rotating knob, press **Enter** key to confirm, then screen will show information indicate data is saving. It takes about 20 seconds to save.

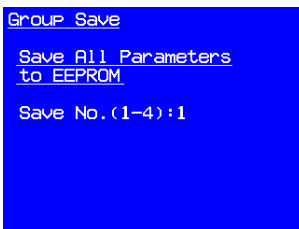

```
Group Save
Save All Parameters
to EEPROM
Save No. (1-4) :1
```

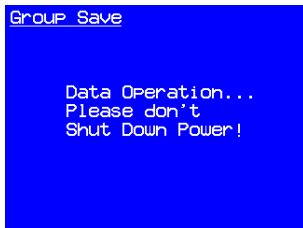



## Recall the main page setting

### How to back to default factory settings

---

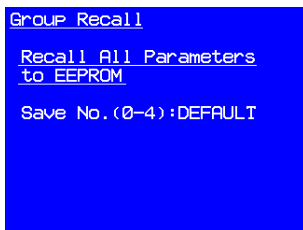
- Operation step
1. At advanced parameters setting manual, long press  **Recall** key for two seconds will enter recall system setting page. DEFAULT is the default factory settings.



2. Press  **Enter** key to confirm. The screen will show information about 25~30 seconds indicating data is saving.

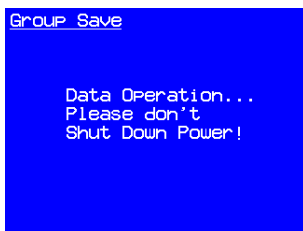

Note

If voltage setting exceeds V Limit after recalling, AC source will limit voltage setting at

# RREMOTE OPERAION

ASD-1900 can be remotely controlled by GPIB or RS-232. GPIB interface is an 8-bit parallel data bus with other control lines to manage communication. RS-232 transmits data in series so communication speed is slower.

If transmission speed is faster than data processing speed of micro-processor, micro-processor will neglect new received command when there is command under processing.

---

Set GPIB address and RS-232 Parameters .....	88
RS-232 pin definition .....	88
GPIB Interface .....	88
Programming.....	90
Conventions .....	90
Numerical Data Formats .....	90
Boolean Data Format.....	90
Basic Definition of Command.....	90
Command List .....	93
Command for Remote Control .....	96

## Set GPIB address and RS-232 Parameters

GPIB and RS-232 parameters can be set at CONFIG page. Default address of GPIB is 30, baud rate of RS232 is 9600, and Even/odd parity check of RS232 is NONE.

### RS-232 pin definition

RS-232 interface uses RXD and TXD signals only. RS-232 implements 9PIN D-SUB type female connector, pin definition is listed as below.

Orders	Input/ Output	Definition
1	NC	NC
2	OUTPUT	TXD
3	INPUT	RXD
4	NC	NC
5	GND	GND
6	NC	NC
7	NC	NC
8	NC	NC
9	NC	NC

### GPIB Interface

GPIB function	Explanation	Interface function
Sender/ receiver	GPIB bus may transmit or receive data by this function. Use following commands to read information.	AH1, SH1, T6, L4
Service request	AC source will pull SRQ pin to low voltage when interfaced instruments have service request.	SR1
Remote/ local control	AC source can be controlled by front panel locally or GPIB	RL1



remotely.

Press **- / Unlock** key to switch from remote control back to local control, other keys are inactive during remote control.

- Operation step
- Screen shows **>REMOTE<** when AC source is in remote control as below

The screenshot shows a blue background with white text. At the top, it displays '>REMOTE<' and 'Three (SYN.)'. Below that, it shows '→U : 110.0' and 'F : 60.0'. A horizontal line separates this from the 'Meter Report: (Overview)' section, which contains a table of electrical parameters.

Meter Report: (Overview)			
V $\phi$ 1:	0.0	I $\phi$ 1:	0.00
V $\phi$ 2:	0.0	I $\phi$ 2:	0.00
V $\phi$ 3:	0.0	I $\phi$ 3:	0.00
P $\phi$ 1:	0.0	$\Sigma$ I :	0.00
P $\phi$ 2:	0.0	$\Sigma$ P :	0.0
P $\phi$ 3:	0.0		

## Programming

All commands and responses are transferred in the form of ASCII code. Response must be received completely before sending a new command. Otherwise, error will occur due to message disorder.

### Conventions

Angle bracket	<>	Items in angle brackets are abbreviations for parameter.
Vertical Bar		To separate multiple selections
Square bracket	[]	Contents within the square bracket are optional.
Curve bracket	{}	Parameter inside curve bracket can be repeated or omitted.

### Numerical Data Formats

All data used for programming are ASCII codes. They can be number or character string with following format.

Symbol	Explanation	Example
NR1	Number without decimal point	1234, 0246
NR2	Number with decimal point	1.23, .456
NR3	Number with decimal point and exponent	1.234E+5

### Boolean Data Format

The Boolean parameter <Boolean> uses the form ON | OFF only.

### Basic Definition of Command

Construction of ASD-1900 remote control command is based on tree systems and every command must have a full path so instrument can receive it.

Tree structure use ":" as node. Command or data at left side of node is in higher level while at right side is in detail level. The

higher level commands are more close to left side, and the more detailed commands are more close to right side.

ASD-1900 includes two distinctive types of command. The first one is command described in IEEE 488.2, it is common commands for GPIB, represented by "\*" at beginning of the command. The second one is instruments self-defined commands. All commands are not upper/ lower case sensitive. There are some special symbols in commands.

- Colon (:)  
Colon represents node for tree system, use colon to separate different parameter until complete command constructed. For example:  
VOLT:AC?

---

Example      VOLT:AC?

---

- Question mark (?)  
Question mark represents this message is question, instruments will prepare the answers for sender to read. If sender does not read after sending questions, instrument will reserve the answer for last question command.

---

Example      Computer side: VOLT:AC?  
                 Instrument side: 150.0

---

- Semicolon(;)
 

There are two usages for semicolon:

  1. Back to previous node,

---

Example      VOLT:AC 100;LIM:AC 200

---

Explanation    The above instruction has two commands which are VOLT:AC 100 and VOLT:LIM:AC 200 (;) can save one repeated string VOLT and complete two commands in one instruction, instrument will execute commands in sequence.

---

2. First input semicolon then colon, represents command branches from beginning.

---

Example      VOLT:AC  
100;;FETCh:CURRent:AC?

Explanation    The above instruction has two commands which are VOLT:AC 100 and FETCh:CURRent:AC?. Using (;) can connect commands more than two.

- Space():  
Space is used to separate command and number or string after it. Instrument differentiates command and data by space.

Example      VOLT:AC 100

- Star(\*):  
Star represents this command is follow the standard of IEEE 488.2, it can be used for all instruments support IEEE 488.2 command.

Example      \*IDN?

Explanation    Common command to query instrument name. Instrument will answer its series number.  
**GW-INSTEK, ASD-1900,V1.0**  
will be the answer for this AC source.

## Command List

IEEE 488.2	*ESE.....	96
Standard	*ESR.....	97
Commands	*IDN .....	97
	*RCL .....	97
	*SAV .....	98
	*SRE.....	98
	*STB.....	99
	*CLS.....	99

FETCH and MEASURE Commands	:FETCh:CURRent:AC :MEASure:CURRent:AC .....	101
	:FETCh:CURRent:(1, 2, 3)	
	:MEASure:CURRent:AC:(1, 2, 3).....	101
	:FETCh:CURRent:AMPLitude:MAXimum	
	:MEASure:CURRent:AMPLitude:MAXimum .....	101
	:FETCh:CURRent:AMPLitude:MAXimum:(1, 2, 3)	
	:MEASure:CURRent:AMPLitude:MAXimum:(1, 2, 3) 102	
	:FETCh:CURRent:CREStfactor	
	:MEASure:CURRent:CREStfactor .....	102
	:FETCh:CURRent:CREStfactor:(1, 2, 3)	
	:MEASure:CURRent:CREStfactor:(1, 2, 3).....	102
	:FETCh:CURRent:INRush	
	:MEASure:CURRent:INRush.....	102
	:FETCh:CURRent:INRush:(1, 2, 3)	
	:MEASure:CURRent:INRush:(1, 2, 3) .....	103
	:FETCh:FREQuency :MEASure:FREQuency.....	103
	:FETCh:FREQuency:(1, 2, 3)	
	:MEASure:FREQuency:(1, 2, 3).....	103
	:FETCh:POWer:AC[:REAL]	
	:MEASure:POWer:AC[:REAL].....	103
:FETCh:POWer:AC[:REAL]:(1, 2,		
3) :MEASure:POWer:AC[:REAL]:(1, 2, 3).....	104	
:FETCh:POWer:AC:APParent		
:MEASure:POWer:AC:APParent.....	104	
:FETCh:POWer:AC:APParent:(1, 2, 3)		
:MEASure:POWer:AC:APParent:(1, 2, 3).....	104	
:FETCh:POWer:AC:PFACtor		
:MEASure:POWer:AC:PFACtor .....	104	
:FETCh:POWer:AC:PFACtor:(1, 2, 3)		
:MEASure:POWer:AC:PFACtor:(1, 2, 3).....	105	
:FETCh:POWer:AC:REACTIVE		

---

	:MEASure:POWer:AC:REACtive.....	105
	:FETCh:POWer:AC:REACtive:(1, 2, 3)	
	:MEASure:POWer:AC:REACtive:(1, 2, 3) .....	105
	:FETCh:VOLTage:AC :MEASure:VOLTage:AC.....	106

---

OUTPUT	:OUTPut .....	107
Commands	:OUTPut:MODE .....	107

---

Source	[:SOURce]:CURRent:LIMit.....	110
Commands	[:SOURce]:CURRent:DELay .....	110
	[:SOURce]:CURRent:INRush:STARt .....	110
	[:SOURce]:CURRent:INRush:INTerval.....	111
	[:SOURce]:FREQuency .....	111
	[:SOURce]:FUNCTion:SHAPE.....	111
	[:SOURce]:FUNCTion:SHAPE:A.....	112
	[:SOURce]:FUNCTion:SHAPE:A:CF .....	112
	[:SOURce]:FUNCTion:SHAPE:B.....	112
	[:SOURce]:FUNCTion:SHAPE:B:CF .....	113
	[:SOURce]:VOLTage:AC.....	113
	[:SOURce]:VOLTage:AC:(1, 2, 3).....	114
	[:SOURce]:VOLTage:LIMit:AC.....	114
	[:SOURce]:VOLTage:RANGe .....	114
	[:SOURce]:VOLTage:SENSe.....	115
	[:SOURce]:CONFigure:INHibit.....	115
	[:SOURce]:PHASe:ON .....	116
	[:SOURce]:PHASe:OFF .....	116
	[:SOURce]:PHASe:2.....	116
	[:SOURce]:PHASe:3.....	117
	[:SOURce]:LIST:COUNT.....	117
	[:SOURce]:LIST:DWELL.....	117
	[:SOURce]:LIST:SHAPE .....	118
	[:SOURce]:LIST:VOLTage:AC:STARt.....	118
	[:SOURce]:LIST:VOLTage:AC:END .....	118
	[:SOURce]:LIST:FREQuency:STARt.....	119
	[:SOURce]:LIST:FREQuency:END .....	119
	[:SOURce]:LIST:DEGREE .....	119
	[:SOURce]:PULSe:VOLTage:AC.....	120
	[:SOURce]:PULSe:FREQuency.....	120
	[:SOURce]:PULSe:SPHase .....	120
	[:SOURce]:PULSe:COUNT .....	121
	[:SOURce]:PULSe:DCYCLE.....	121
	[:SOURce]:PULSe:PERiod.....	121
	[:SOURce]:STEP:VOLTage:AC.....	122
	[:SOURce]:STEP:DVOLTage:AC .....	122

---

---

	[:SOURce]:STEP:FREQency.....	122
	[:SOURce]:STEP:DFREQency .....	123
	[:SOURce]:STEP:SPHase .....	123
	[:SOURce]:STEP:DWELl .....	123
	[:SOURce]:STEP:COUNt.....	124
	[:SOURce]:SYNTHeSis .....	124
	[:SOURce]:SYNTHeSis:AMPLitude .....	125
	[:SOURce]:SYNTHeSis:PHASe.....	125

---

Other Commands	:TRIG .....	126
	:NPHase.....	126
	:INSTrument:NSELect 1   2   3.....	127
	:VERion:DSP? .....	127
	:VERion:LCM? .....	128
	:VERion:UI? .....	128

# Command for Remote Control

## IEEE 488.2 Standard Commands

*ESE.....	96
*ESR.....	97
*IDN.....	97
*RCL.....	97
*SAV.....	98
*SRE.....	98
*STB.....	99
*CLS.....	99

### \*ESE

→ Query

#### Description

Set and query flag mask for standard event status register.

This command is for a register used for IEEE488.2 defined standard events. It is used for flag mask or control enable. Set by 1 enables target event detection, and event detection is masked if setting is 0. No response to target events when 0 is set.

Bits configuration for standard events register are as follow.

Bit	Bit name	Bit definition
0	OPC	Operation completed
1	-----	
2	QYE	Query error
3	DDE	Error related to instrument
4	EXE	Execution error
5	CME	Command error
6	-----	



	7	PON	Power on
--	---	-----	----------

Syntax \*ESE<NR1>

Query Syntax \*ESE?

Parameter/  
Return parameter <NR1>

**\*ESR → Query**

Description Query value stored in standard events status register, 1 represents event occurs.

Query Syntax \*ESR?

**\*IDN → Query**

Description Return string of AC source identification.

Query Syntax \*IDN?

Return parameter <string> Returns the instrument identification as a string in the following format:  
 GW-INSTEK, ASD-1900, V1.0  
 Manufacturer: GW-INSTEK  
 Model number: ASD-1900  
 Firmware version: V1.0

**\*RCL Set →**

Description Recalls stored system setting.

Syntax \*RCL<n>

Parameter  
 1  
 2  
 3  
 4

**\*SAV**

Set →

Description	Save system setting
Syntax	*SAV<n>
Return parameter	1 2 3 4

Set →

**\*SRE**

→ Query

**Description** Set and return status of flag mask status for service events.

This command is for a register used for IEE488.2 and instrument defined service events. It is used for flag mask or control enable. Set by 1 enables target event detection, and event detection is masked if setting is 0. No response to target events when 0 is set.

Bits configuration for service events register are as follow.

Bit	Bit name	Bit definition
0	-----	
1	-----	
2	-----	
3	-----	Info. available
4	MAV	Info. Available
5	ESB	Brief info. For service event register
6	MSS/SRQ	Service request
7	-----	

Syntax	*SRE <n>
--------	----------

Query Syntax	*SRE?
--------------	-------

Parameter/ Return parameter	<NR1>
--------------------------------	-------

**\*STB**

→ Query

Description	Query value stored in service event register, 1 represents event occurs.
-------------	--

Query Syntax	*STB?
--------------	-------

Return parameter	<NR1>
------------------	-------

**\*CLS**

Set →

Description	<p>Clear status. Following operation may execute depends on different conditions.</p> <ol style="list-style-type: none"> <li>1. Leave REMOTE control, back to panel control.</li> <li>2. When one of the following error occurs, AC source will turn off output, clear error status and return to main page. <ul style="list-style-type: none"> <li>• Software OCP</li> <li>• D2A OCP Fault</li> <li>• D2A OPP Fault</li> </ul> </li> </ol>
-------------	---

Syntax	*CLS
--------	------

## FETCH and MEASURE Commands

Differences between FETCH and MEASURE are: FETCH reads existing measurements value. Execution time is shorter because data is available immediately but the data may not be the newest. Instrument will send the next sampling data to the computer after receiving MEASURE command. There is time delay so 100ms time interval between MEASURE command and query command is recommended. MEASURE command is suitable for the requirement of updated measurement value after power supply out status changed.

---

:FETCh:CURRent:AC :MEASure:CURRent:AC.....	101
:FETCh:CURRent:(1, 2, 3)	
:MEASure:CURRent:AC:(1, 2, 3).....	101
:FETCh:CURRent:AMPLitude:MAXimum	
:MEASure:CURRent:AMPLitude:MAXimum.....	101
:FETCh:CURRent:AMPLitude:MAXimum:(1, 2, 3)	
:MEASure:CURRent:AMPLitude:MAXimum:(1, 2, 3)	102
:FETCh:CURRent:CREStfactor	
:MEASure:CURRent:CREStfactor .....	102
:FETCh:CURRent:CREStfactor:(1, 2, 3)	
:MEASure:CURRent:CREStfactor:(1, 2, 3).....	102
:FETCh:CURRent:INRush	
:MEASure:CURRent:INRush .....	102
:FETCh:CURRent:INRush:(1, 2, 3)	
:MEASure:CURRent:INRush:(1, 2, 3) .....	103
:FETCh:FREQuency :MEASure:FREQuency.....	103
:FETCh:FREQuency:(1, 2, 3)	
:MEASure:FREQuency:(1, 2, 3).....	103
:FETCh:POWer:AC[:REAL]	
:MEASure:POWer:AC[:REAL] .....	103
:FETCh:POWer:AC[:REAL]:(1, 2,	
3) :MEASure:POWer:AC[:REAL]:(1, 2, 3).....	104
:FETCh:POWer:AC:APParent	
:MEASure:POWer:AC:APParent .....	104
:FETCh:POWer:AC:APParent:(1, 2, 3)	
:MEASure:POWer:AC:APParent:(1, 2, 3) .....	104
:FETCh:POWer:AC:PFACtor	
:MEASure:POWer:AC:PFACtor.....	104
:FETCh:POWer:AC:PFACtor:(1, 2, 3)	
:MEASure:POWer:AC:PFACtor:(1, 2, 3) .....	105

```

:FETCh:POWer:AC:REACtive
:MEASure:POWer:AC:REACtive ..... 105
:FETCh:POWer:AC:REACtive:(1, 2, 3)
:MEASure:POWer:AC:REACtive:(1, 2, 3) ..... 105
:FETCh:VOLTage:AC :MEASure:VOLTage:AC ..... 106
    
```

```

:FETCh:CURRent:AC
:MEASure:CURRent:AC → Query
    
```

Description	Query total output AC Irms.
Syntax	:FETCh:CURRent:AC? :MEASure:CURRent:AC?
Return Parameter	<NR2>

```

:FETCh:CURRent:(1, 2, 3)
:MEASure:CURRent:AC:(1, 2, 3) → Query
    
```

Description	Query output AC Irms for each phase
Syntax	:FETCh:CURRent:AC:(1, 2, 3)? :MEASure:CURRent:AC:(1, 2, 3)?
Return Parameter	<NR2>
Example	:FETCh:CURRent:AC:1? :MEASure:CURRent:AC:2?

```

:FETCh:CURRent:AMPLitude:MAXimum
:MEASure:CURRent:AMPLitude:MAXimum → Query
    
```

Description	Query total output peak current
Syntax	:FETCh:CURRent:AMPLitude:MAXimum? :MEASure:CURRent:AMPLitude:MAXimum?
Return Parameter	<NR2>

:FETCh:CURRent:AMPLitude:MAXimum:(1, 2, 3)  
 :MEASure:CURRent:AMPLitude:MAXimum:(1, 2, 3) → Query

Description	Query output peak current for each phase
Syntax	:FETCh:CURRent:AMPLitude:MAXimum:(1, 2, 3)? :MEASure:CURRent:AMPLitude:MAXimum:(1, 2, 3)?
Return Parameter	<NR2>
Example	:FETCh:CURRent:AMPLitude:MAXimum:1? :MEASure:CURRent:AMPLitude:MAXimum:2?

:FETCh:CURRent:CREStfactor  
 :MEASure:CURRent:CREStfactor → Query

Description	Query output current crest factor
Syntax	:FETCh:CURRent:CREStfactor? :MEASure:CURRent:CREStfactor?
Return Parameter	<NR2>

:FETCh:CURRent:CREStfactor:(1, 2, 3)  
 :MEASure:CURRent:CREStfactor:(1, 2, 3) → Query

Description	Query output current crest factor for each phase
Syntax	:FETCh:CURRent:CREStfactor:(1, 2, 3)? :MEASure:CURRent:CREStfactor:(1, 2, 3)?
Return Parameter	<NR2>
Example	:FETCh:CURRent:CREStfactor:1? :MEASure:CURRent:CREStfactor:2?

:FETCh:CURRent:INRush  
 :MEASure:CURRent:INRush → Query

Description	Query output inrush current
-------------	-----------------------------

Syntax :FETCh:CURRent:INRush?  
:MEASure:CURRent:INRush?

Return Parameter <NR2>

:FETCh:CURRent:INRush:(1, 2, 3)  
:MEASure:CURRent:INRush:(1, 2, 3) → **Query**

Description Query output inrush current for each phase

Syntax :FETCh:CURRent:INRush:(1, 2, 3)?  
:MEASure:CURRent:INRush:(1, 2, 3)?

Return Parameter <NR2>

Example :FETCh:CURRent:INRush:1?  
:MEASure:CURRent:INRush:2?

:FETCh:FREQuency :MEASure:FREQuency → **Query**

Description Query average output frequency

Syntax :FETCh:FREQuency? :MEASure:FREQuency?

Return Parameter <NR2>

:FETCh:FREQuency:(1, 2, 3)  
:MEASure:FREQuency:(1, 2, 3) → **Query**

Description Query output frequency for each phase

Syntax :FETCh:FREQuency:(1, 2, 3)?  
:MEASure:FREQuency:(1, 2, 3)?

Return Parameter <NR2>

Example :FETCh:FREQuency: 1?  
:MEASure:FREQuency: 2?

:FETCh:POWer:AC[:REAL]  
:MEASure:POWer:AC[:REAL] → **Query**

Description Query output real power

Syntax :FETCh:POWer:AC? :MEASure:POWer:AC:REAL?

Return Parameter <NR2>

:FETCh:POWer:AC[:REAL]:(1, 2, 3)

:MEASure:POWer:AC[:REAL]:(1, 2, 3)

→ Query

Description Query output real power for each phase

Syntax :FETCh:POWer:AC:(1, 2, 3)?

:MEASure:POWer:AC:REAL:(1, 2, 3)?

Return Parameter <NR2>

Example :FETCh:POWer:AC:1?

:MEASure:POWer:AC:REAL:2?

:FETCh:POWer:AC:APParent

:MEASure:POWer:AC:APParent

→ Query

Description Query output apparent power

Syntax :FETCh:POWer:AC:APParent?

:MEASure:POWer:AC:APParent?

Return Parameter <NR2>

:FETCh:POWer:AC:APParent:(1, 2, 3)

:MEASure:POWer:AC:APParent:(1, 2, 3)

→ Query

Description Query apparent power for each phase

Syntax :FETCh:POWer:AC:APParent:(1, 2, 3)?

:MEASure:POWer:AC:APParent:(1, 2, 3)?

Return Parameter <NR2>

Example :FETCh:POWer:AC:APParent:1?

:MEASure:POWer:AC:APParent:2?

:FETCh:POWer:AC:PFACTOR

:MEASure:POWer:AC:PFACTOR

→ Query

Description Query output power factor



Syntax :FETCh:POWer:AC:PFACtor?  
:MEASure:POWer:AC:PFACtor?

Return Parameter <NR2>

:FETCh:POWer:AC:PFACtor:(1, 2, 3)  
:MEASure:POWer:AC:PFACtor:(1, 2, 3) → **Query**

Description Query power factor for each phase

Syntax :FETCh:POWer:AC:PFACtor:(1, 2, 3)?  
:MEASure:POWer:AC:PFACtor:(1, 2, 3)?

Return Parameter <NR2>

Example :FETCh:POWer:AC:APParent:1?  
:MEASure:POWer:AC:APParent:2?

:FETCh:POWer:AC:REACTive  
:MEASure:POWer:AC:REACTive → **Query**

Description Query output reactive power

Syntax :FETCh:POWer:AC:REACTive?  
:MEASure:POWer:AC:REACTive?

Return Parameter <NR2>

:FETCh:POWer:AC:REACTive:(1, 2, 3)  
:MEASure:POWer:AC:REACTive:(1, 2, 3) → **Query**

Description Query reactive power for each phase

Syntax :FETCh:POWer:AC:REACTive:(1, 2, 3)?  
:MEASure:POWer:AC:REACTive:(1, 2, 3)?

Return Parameter <NR2>

Example :FETCh:POWer:AC:REACTive:1?  
:MEASure:POWer:AC:REACTive:2?

:FETCh:VOLTage:AC

:MEASure:VOLTage:AC

→ Query

Description      Query average output voltage Vrms

Syntax            :FETCh:VOLTage:AC?:MEASure:VOLTage:AC?

Return Parameter <NR2>

:FETCh:VOLTage:AC:(1,2, 3)

:MEASure:VOLTage:AC:(1, 2, 3)

→ Query

Description      Query output voltage Vrms for each phase

Syntax            :FETCh:VOLTage:AC:(1, 2, 3)?  
:MEASure:VOLTage:AC(1, 2, 3)?

Return Parameter <NR2>

Example          :FETCh: VOLTage:AC :1?  
:MEASure: VOLTage:AC:2?

## OUTPUT Commands

:OUTPut.....	107
:OUTPut:MODE.....	107

### :OUTPut

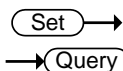

Description	Set or query status of turning on or turning off output.
Syntax	OUTPut
Query Syntax	OUTPut?
Parameter/Return parameter	OFF ON
Example	OUTPut? OUTPut ON Query output status. Turn on output.

### :OUTPut:MODE

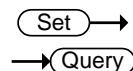

Description	Set or query output mode. "FIXED" mode output fixed voltage waveform.
Syntax	OUTPut:MODE
Query Syntax	OUTPut:MODE?
Parameter/Return parameter	FIXED LIST PULSE STEP

Example	OUTPut:MODE? OUTPut:MODE LIST Query output mode. Set output as LIST mode.
---------	--

## SOURCE Commands

[:SOURce]:CURRent:LIMit .....	110
[:SOURce]:CURRent:DELay .....	110
[:SOURce]:CURRent:INRush:STARt .....	110
[:SOURce]:CURRent:INRush:INTerval .....	111
[:SOURce]:FREQuency .....	111
[:SOURce]:FUNCTion:SHAPE.....	111
[:SOURce]:FUNCTion:SHAPE:A .....	112
[:SOURce]:FUNCTion:SHAPE:A:CF .....	112
[:SOURce]:FUNCTion:SHAPE:B.....	112
[:SOURce]:FUNCTion:SHAPE:B:CF .....	113
[:SOURce]:VOLTage:AC .....	113
[:SOURce]:VOLTage:AC:(1, 2, 3).....	114
[:SOURce]:VOLTage:LIMit:AC.....	114
[:SOURce]:VOLTage:RANGe .....	114
[:SOURce]:VOLTage:SENSe .....	115
[:SOURce]:CONFigure:INHibit .....	115
[:SOURce]:PHASe:ON .....	116
[:SOURce]:PHASe:OFF .....	116
[:SOURce]:PHASe:2 .....	116
[:SOURce]:PHASe:3 .....	117
[:SOURce]:LIST:COUNT .....	117
[:SOURce]:LIST:DWELL.....	117
[:SOURce]:LIST:SHAPE.....	118
[:SOURce]:LIST:VOLTage:AC:STARt .....	118
[:SOURce]:LIST:VOLTage:AC:END.....	118
[:SOURce]:LIST:FREQuency:STARt .....	119
[:SOURce]:LIST:FREQuency:END.....	119
[:SOURce]:LIST:DEGRee .....	119
[:SOURce]:PULSe:VOLTage:AC.....	120
[:SOURce]:PULSe:FREQuency.....	120
[:SOURce]:PULSe:SPHase .....	120
[:SOURce]:PULSe:COUNT.....	121
[:SOURce]:PULSe:DCYCLE .....	121
[:SOURce]:PULSe:PERiod.....	121
[:SOURce]:STEP:VOLTage:AC.....	122
[:SOURce]:STEP:DVOLTage:AC.....	122
[:SOURce]:STEP:FREQuency.....	122
[:SOURce]:STEP:DFREQuency .....	123
[:SOURce]:STEP:SPHase .....	123
[:SOURce]:STEP:DWELL .....	123

[:SOURce]:STEP:COUNT.....	124
[:SOURce]:SYNThesis .....	124
[:SOURce]:SYNThesis:AMPLitude .....	125
[:SOURce]:SYNThesis:PHASe.....	125

Set →  
 → Query

**[:SOURce]:CURRent:LIMit**

Description	Set or query total output rms current limit
Syntax	[:SOURce:]CURRent:LIMit
Query Syntax	[:SOURce:]CURRent:LIMit?
Parameter/ Return parameter	<NR2> Effective rang: 0.00 ~ 64.00 (150V range), 0.00 ~ 48.00 (300V range)
Example	[:SOURce:]CURRent:LIMit 25.5

Set →  
 → Query

**[:SOURce]:CURRent:DELay**

Description	Set or query delay time to trigger software over current protection.
Syntax	[:SOURce:]CURRent:DELay
Query Syntax	[:SOURce:]CURRent:DELay?
Parameter/ Return parameter	<NR2> Effective range: 0.0 ~ 9.0 (unit: sec)
Example	[:SOURce:]CURRent:DELay? 1.2

Set →  
 → Query

**[:SOURce]:CURRent:INRush:START**

Description	Set or query time to start measure inrush current.
Syntax	[:SOURce:]CURRent:INRush:START
Query Syntax	[:SOURce:]CURRent:INRush:START?

Parameter/ Return parameter	<NR2>	Effective rang: 0.0 ~ 9000.0 (unit: msec)
--------------------------------	-------	---

Example	[[:SOURce:]CURRent:INRush:STARt? 200.3
---------	---

**[[:SOURce:]CURRent:INRush:INTerval**

Set →  
→ Query

Description	Set or query inrush current measurement time.
-------------	---

Syntax	[[:SOURce:]CURRent:INRush:INTerval
--------	------------------------------------

Query Syntax	[[:SOURce:]CURRent:INRush:INTerval?
--------------	-------------------------------------

Parameter/ Return parameter	<NR2>	Effective rang: 0.0 ~ 9000.0 (unit: msec)
--------------------------------	-------	---

Example	[[:SOURce:]CURRent:INRush:INTerval? 400.8
---------	--

**[[:SOURce:]FREQuency**

Set →  
→ Query

Description	Set or query frequency of output waveform.
-------------	--

Syntax	[[:SOURce:]FREQuency
--------	----------------------

Query Syntax	[[:SOURce:]FREQuency?
--------------	-----------------------

Parameter/ Return parameter	<NR2>	Effective rang: 30.0 ~ 1000.0 (unit: Hz)
--------------------------------	-------	--

Example	[[:SOURce:]CURRent:INRush:INTerval? 50.8
---------	---

**[[:SOURce:]FUNctIon:SHAPE**

Set →  
→ Query



Description	Set or query waveform buffer. AC source provides two waveform buffers, user has to select A or B waveform buffer.
-------------	---

Syntax	[[:SOURce:]FUNctIon:SHAPE
--------	---------------------------

Query Syntax	[[:SOURce:]FUNctIon:SHAPE?
--------------	----------------------------

Parameter/Return parameter	A
	B

Example           [:SOURce:]FUNCTioN:SHAPE?  
A

[:SOURce]:FUNCTioN:SHAPE:A 





Description       Set or query waveform of waveform buffer A.

Syntax           [:SOURce:]FUNCTioN:SHAPE:A

Query Syntax     [:SOURce:]FUNCTioN:SHAPE:A?

Parameter/ Return parameter	SINE
	CSIN
	DST<00~31>

Example           [:SOURce:]FUNCTioN:SHAPE:A?  
CSIN

[:SOURce]:FUNCTioN:SHAPE:A:CF 





Description       Set or query CF of the cut sin waveform in waveform buffer A. It is effective only when CSIN is selected for waveform buffer A.

Syntax           [:SOURce:]FUNCTioN:SHAPE:A:CF

Query Syntax     [:SOURce:]FUNCTioN:SHAPE:A:CF?

Parameter/ Return parameter	<NR2>	Effective rang: 1.200 ~ 1.414
--------------------------------	-------	-------------------------------

Example           [:SOURce:]FUNCTioN:SHAPE:A:CF?  
1.234

[:SOURce]:FUNCTioN:SHAPE:B 



Description       Set or query waveform of waveform buffer B.

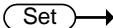
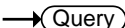

Syntax	[[:SOURce:]]FUNcTion:SHAPE:B
Query Syntax	[[:SOURce:]]FUNcTion:SHAPE:B?
Parameter/ Return parameter	SINE CSIN DST<00~31>
Example	[[:SOURce:]]FUNcTion:SHAPE:B? CSIN

[[:SOURce:]]FUNcTion:SHAPE:B:CF 

  

**Description** Set or query CF of the cut sin waveform in waveform buffer B. It is effective only when CSIN is selected for waveform buffer B.

Syntax	[[:SOURce:]]FUNcTion:SHAPE:B:CF
Query Syntax	[[:SOURce:]]FUNcTion:SHAPE:B:CF?
Parameter/ Return parameter	<NR2> Effective rang: 1.200 ~ 1.414
Example	[[:SOURce:]]FUNcTion:SHAPE:B:CF? 1.234

[[:SOURce:]]VOLTage:AC 

**Description** Set or query AC output voltage.

Syntax	[[:SOURce:]]VOLTage:AC
Query Syntax	[[:SOURce:]]VOLTage:AC?
Parameter/ Return parameter	<NR2> Effective range: 0.0 ~ 150.0 (low voltage range), 0.0 ~ 300.0 (high voltage range)
Example	[[:SOURce:]]VOLTage:AC? 200.5

Set →

**[:SOURce]:VOLTage:AC:(1, 2, 3)**

→ Query

Description	Set or query output voltage for each phase when output is in three phase mode	
Syntax	[:SOURce:]VOLTage:AC:(1, 2, 3)	
Query Syntax	[:SOURce:]VOLTage:AC:(1, 2, 3)?	
Parameter/ Return parameter	<NR2>	Effective range: 0.0 ~ 150.0 (150V voltage range), 0.0 ~ 300.0 (300V voltage range)
Example	[:SOURce:]VOLTage:AC:3 200.5 [:SOURce:]VOLTage:AC:1?	

Set →

**[:SOURce]:VOLTage:LIMit:AC**

→ Query

Description	Set or query voltage limit.	
Syntax	[:SOURce:]VOLTage:LIMit:AC	
Query Syntax	[:SOURce:]VOLTage:LIMit:AC?	
Parameter/ Return parameter	<NR2>	Effective range: 0.0 ~ 150.0 (low voltage range), 0.0 ~ 300.0 (high voltage range)
Example	[:SOURce:]VOLTage:LIMit:AC? 300.0	

Set →

**[:SOURce]:VOLTage:RANGe**

→ Query

Description	Set or query output voltage range.		
		Voltage range(V)	Current range(A)
	LOW	0.0 ~ 150.0	0.0 ~ 32.0
	HIGH	0.0 ~ 300.0	0.0 ~ 16.0
Syntax	[:SOURce:]VOLTage:RANGe		
Query Syntax	[:SOURce:]VOLTage:RANGe?		

Parameter/ Return parameter	LOW HIGH
Example	[:SOURce:]VOLTage:RANGe? HIGH

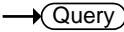
[:SOURce]:VOLTage:SENSe 

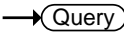

Description	Set or query remote sense function. REMOTE is in enable, VOUT is in disable
Syntax	[:SOURce:]VOLTage:SENSe
Query Syntax	[:SOURce:]VOLTage:SENSe?

Parameter/ Return parameter	VOUT REMOTE
Example	[:SOURce:]VOLTage:SENSe? REMOTE

[:SOURce]:CONFigure:INHibit 

  

Description	Set or query remote TTL inhibition operation. Refer to page 64 for details.
Syntax	[:SOURce:]CONFigure:INHibit
Query Syntax	[:SOURce:]CONFigure:INHibit?

Parameter/ Return parameter	OFF LIVE TRIG EXCITE
--------------------------------	-------------------------------

Example	[:SOURce:]CONFigure:INHibit? LIVE
---------	--------------------------------------

Set →  
 → Query

**[[:SOURce]:]PHASe:ON**

Description	Set or query waveform start phase angle set at main menu.
Syntax	[[:SOURce:]PHASe:ON
Query Syntax	[[:SOURce:]PHASe:ON?
Parameter/ Return parameter	<NR2> Effective rang: 0.0 ~ 359.9
Example	[[:SOURce:]PHASe:ON? 200.5

Set →  
 → Query

**[[:SOURce]:]PHASe:OFF**

Description	Set or query waveform stop phase angle set at main menu.
Syntax	[[:SOURce:]PHASe:OFF
Query Syntax	[[:SOURce:]PHASe:OFF?
Parameter/ Return parameter	<NR2> Effective rang: 0 ~ 360.0, 360.0 representing turn off immediately
Example	[[:SOURce:]PHASe:OFF? 250.5

Set →  
 → Query

**[[:SOURce]:]PHASe:2**

Description	Set or query phase angle of phase 1 leads phase 2.
Syntax	[[:SOURce:]PHASe:2
Query Syntax	[[:SOURce:]PHASe:2?
Parameter/ Return parameter	<NR2> Effective rang: 0.0 ~ 359.9 °
Example	[[:SOURce:]PHASe:2? 200

Set →  
 → Query

**[[:SOURce]:]PHAsE:3**

Description	Set or query phase angle of phase 3 leads phase 2.
Syntax	[[:SOURce]:]PHAsE:3
Query Syntax	[[:SOURce]:]PHAsE:3?
Parameter/ Return parameter	<NR2> Effective rang: 0.0 ~ 359.9 °
Example	[[:SOURce]:]PHAsE:3? 200.5

Set →  
 → Query

**[[:SOURce]:]LIST:COUNT**

Description	Set or query how many times to execute effective sequences in LIST mode.
Syntax	[[:SOURce]:]LIST:COUNT
Query Syntax	[[:SOURce]:]LIST:COUNT?
Parameter/ Return parameter	<NR1> Effective rang: 0 ~ 10000
Example	[[:SOURce]:]LIST:COUNT? 100

Set →  
 → Query

**[[:SOURce]:]LIST:DWELL**

Description	Set or query execution time of 10 individual sequences in LIST mode.
Syntax	[[:SOURce]:]LIST:DWELL
Query Syntax	[[:SOURce]:]LIST:DWELL?
Parameter/ Return parameter	<NR2>... Effective rang: 0 ~ 60000 (unit: msec) <NR2>
Example	[[:SOURce]:]LIST:DWELL? 60000 1 23 95

Set →  
 → Query

**[:SOURce]:LIST:SHAPE**

Description	Set or query waveform buffer used for 10 individual sequences in LIST mode.
Syntax	[:SOURce:]LIST:SHAPE
Query Syntax	[:SOURce:]LIST:SHAPE?
Parameter/ Return parameter	A B... A B
Example	[:SOURce:]LIST:SHAPE? A B A A A

Set →  
 → Query

**[:SOURce]:LIST:VOLTage:AC:START**

Description	Set or query start voltage of 10 individual sequences in LIST mode.
Syntax	[:SOURce:]LIST:VOLTage:AC:START
Query Syntax	[:SOURce:]LIST:VOLTage:AC:START?
Parameter/ Return parameter	<NR2>... Effective rang: <NR2> 0.0 ~ 150.0 (low voltage range), 0.0 ~ 300.0 (high voltage range)
Example	[:SOURce:]LIST:VOLTage:AC:START? 110 22.5 55.6

Set →  
 → Query

**[:SOURce]:LIST:VOLTage:AC:END**

Description	Set or query stop voltage of 10 individual sequences in LIST mode.
Syntax	[:SOURce:]LIST:VOLTage:AC:END
Query Syntax	[:SOURce:]LIST:VOLTage:AC:END?
Parameter/ Return parameter	<NR2>... Effective rang: <NR2> 0.0 ~ 150.0 (low voltage range), 0.0 ~ 300.0 (high voltage range)

Example           [:SOURce:]LIST:VOLTage:AC:END?  
                  1.2 50 66.6

**[:SOURce:]LIST:FREQency:STARt**

Set →

→ Query

Description       Set or query start frequency of 10 individual sequences in LIST mode.

Syntax           [:SOURce:]LIST:FREQency:STARt

Query Syntax     [:SOURce:]LIST:FREQency:STARt?

Parameter/  
Return parameter <NR2>... Effective rang: 30.0 ~ 1000.0 (unit: Hz)  
                  <NR2>

Example           [:SOURce:]LIST:FREQency:STARt?  
                  50.8 80.5 2.2

Set →

→ Query

**[:SOURce:]LIST:FREQency:END**

Description       Set or query stop frequency of 10 individual sequences in LIST mode.

Syntax           [:SOURce:]LIST:FREQency:END

Query Syntax     [:SOURce:]LIST:FREQency:END?

Parameter/  
Return parameter <NR2>... Effective rang: 30.0 ~ 1000.0 (unit: Hz)  
                  <NR2>

Example           [:SOURce:]LIST:FREQency:END?  
                  20.5 30.8 77.8

Set →

→ Query

**[:SOURce:]LIST:DEGRee**

Description       Set or query start phase angle of 10 individual sequences in LIST mode.

Syntax           [:SOURce:]LIST:DEGRee:END

Query Syntax     [:SOURce:]LIST:DEGRee:END?

Parameter/ Return parameter	<code>&lt;NR2&gt;...</code> <code>&lt;NR2&gt;</code>	Effective rang: 0.0 ~ 359.9
--------------------------------	---	-----------------------------

Example	<code>[:SOURce:]LIST:DEGRee:END?</code> 30.6 96.5 88.0 71
---------	--

**`[:SOURce]:PULSe:VOLTage:AC`**

Set →  
 → Query

Description	Set or query AC voltage of PULSE waveform.
-------------	--

Syntax	<code>[:SOURce:]PULSe:VOLTage:AC</code>
--------	---

Query Syntax	<code>[:SOURce:]PULSe:VOLTage:AC?</code>
--------------	--

Parameter/ Return parameter	<code>&lt;NR2&gt;...</code> <code>&lt;NR2&gt;</code>	Effective rang: 0.0 ~ 150.0 (low voltage range), 0.0 ~ 300.0 (high voltage range)
--------------------------------	---	---

Example	<code>[:SOURce:]PULSe:VOLTage:AC?</code> 250.1
---------	---

**`[:SOURce]:PULSe:FREQuency`**

Set →  
 → Query

Description	Set or query frequency of PULSE mode.
-------------	---------------------------------------

Syntax	<code>[:SOURce:]PULSe:FREQuency</code>
--------	--

Query Syntax	<code>[:SOURce:]PULSe:FREQuency?</code>
--------------	---

Parameter/ Return parameter	<code>&lt;NR2&gt;</code>	Effective rang: 30.0 ~ 1000.0 (unit: Hz)
--------------------------------	--------------------------	--

Example	<code>[:SOURce:]PULSe:FREQuency?</code> 50.0
---------	---

**`[:SOURce]:PULSe:SPHase`**

Set →  
 → Query

Description	Set or query start phase angle of PULSE mode.
-------------	---

Syntax	<code>[:SOURce:]PULSe:SPHase</code>
--------	-------------------------------------

Query Syntax	<code>[:SOURce:]PULSe:SPHase?</code>
--------------	--------------------------------------



Parameter/ Return parameter	<code>&lt;NR2&gt;</code>	Effective rang: 0.0~ 359.9
--------------------------------	--------------------------	----------------------------

Example	<code>[:SOURce:]PULSe:SPHase?</code> 60.0
---------	--

**`[:SOURce]:PULSe:COUNT`**

Set →  
 → Query

Description	Set or query how many times to execute PULSE voltage.
-------------	---

Syntax	<code>[:SOURce:]PULSe:COUNT</code>
--------	------------------------------------

Query Syntax	<code>[:SOURce:]PULSe:COUNT?</code>
--------------	-------------------------------------

Parameter/ Return parameter	<code>&lt;NR1&gt;</code>	Effective rang: 0 ~ 10000
--------------------------------	--------------------------	---------------------------

Example	<code>[:SOURce:]PULSe:COUNT?</code> 500
---------	--

**`[:SOURce]:PULSe:DCYClE`**

Set →  
 → Query

Description	Set or query execution time of PULSE waveform, it must be no longer than total period in PULSE mode.
-------------	--

Syntax	<code>[:SOURce:]PULSe:DCYClE</code>
--------	-------------------------------------

Query Syntax	<code>[:SOURce:]PULSe:DCYClE?</code>
--------------	--------------------------------------

Parameter/ Return parameter	<code>&lt;NR1&gt;</code>	Effective rang: 1 ~ 59999 (unit: msec)
--------------------------------	--------------------------	--

Example	<code>[:SOURce:]PULSe:DCYClE?</code> 300
---------	---

**`[:SOURce]:PULSe:PERiod`**

Set →  
 → Query

Description	Set or query total period of PULSE mode
-------------	---

Syntax	[:SOURce:]PULSe:PERiod
Query Syntax	[:SOURce:]PULSE:PERiod?
Parameter/ Return parameter	<NR1> Effective rang: 2 ~ 16000000 (unit: msec)
Example	[:SOURce:]PULSe:PERiod? 600

Set →

→ Query

**[:SOURce]:STEP:VOLTage:AC**

Description	Set or query start voltage for STEP mode.
Syntax	[:SOURce:]STEP:VOLTage:AC
Query Syntax	[:SOURce:]STEP:VOLTage:AC?
Parameter/ Return parameter	<NR2> Effective rang: 0.0 ~ 150.0 (low voltage range), 0.0 ~ 300.0 (high voltage range)
Example	[:SOURce:]STEP:VOLTage:AC? 150.5

Set →

→ Query

**[:SOURce]:STEP:DVOLTage:AC**

Description	Set or query change of each step in STEP mode.
Syntax	[:SOURce:]STEP:DVOLTage:AC
Query Syntax	[:SOURce:]STEP:DVOLTage:AC?
Parameter/ Return parameter	<NR2> Effective rang: -150.0 ~ 150.0(unit: Volt)
Example	[:SOURce:]STEP:DVOLTage:DC? 20.5

Set →

→ Query

**[:SOURce]:STEP:FREQuency**

Description	Set or query start frequency for STEP mode.
-------------	---

Syntax	[[:SOURce:]]STEP:FREQency
Query Syntax	[[:SOURce:]]STEP:FREQency?
Parameter/ Return parameter	<NR2> Effective rang: 30.0 ~ 1000.0 (unit: Hz)
Example	[[:SOURce:]]STEP:FREQency? 80.5

Set →

→ Query

**[[:SOURce:]]STEP:DFREQency**

Description	Set or query frequency change of each step in STEP mode.
Syntax	[[:SOURce:]]STEP:DFREQency
Query Syntax	[[:SOURce:]]STEP:DFREQency?
Parameter/ Return parameter	<NR2> Effective rang: -150.0 ~ 150.0(unit: Hz)
Example	[[:SOURce:]]STEP:DFREQency? -10.5

Set →

→ Query

**[[:SOURce:]]STEP:SPHase**

Description	Set or query start phase angle at STEP mode.
Syntax	[[:SOURce:]]STEP:SPHase
Query Syntax	[[:SOURce:]]STEP:SPHase?
Parameter/ Return parameter	<NR2> Effective rang: 0.0~ 359.9
Example	[[:SOURce:]]STEP:SPHase? 80.5

Set →

→ Query

**[[:SOURce:]]STEP:DWELL**

Description	Set or query output duration time of each step in STEP mode.
-------------	--

Syntax	[:SOURce:]STEP:DWELl
Query Syntax	[:SOURce:]STEP:DWELl?
Parameter/ Return parameter	<NR2> Effective rang: 1 ~ 6000000 (unit: msec)
Example	STEP:SPHase? 1000.5

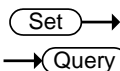

**[:SOURce]:STEP:COUNT**

Description	Set or query how many steps to execute STEP mode.
Syntax	[:SOURce:]STEP:COUNT
Query Syntax	[:SOURce:]STEP:COUNT?
Parameter/ Return parameter	<NR1> Effective rang: 0 ~ 10000
Example	[:SOURce:]STEP:COUNT? 500

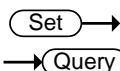

**[:SOURce]:SYNThesis**

Description	Set or query which synthesis waveform to use. There are DIS30 and DIS31 available.
Syntax	[:SOURce:]SYNThesis
Query Syntax	[:SOURce:]SYNThesis?
Parameter/ Return parameter	DST30 DST31
Example	[:SOURce:]SYNThesis? DST30

**[[:SOURce]:SYNTHeSis:AMPLitude]** 
 →  
 →

Description	Set or query voltage amplitude for each order of harmonic waveforms. Maximum order is 39.								
Syntax	[[:SOURce]:SYNTHeSis:AMPLitude								
Query Syntax	[[:SOURce]:SYNTHeSis:AMPLitude?								
	<table border="0"> <tr> <td style="background-color: #cccccc; padding: 2px;"><code>&lt;NR2&gt;...</code></td> <td>Effective rang</td> </tr> <tr> <td style="background-color: #cccccc; padding: 2px;"><code>&lt;NR2&gt;</code></td> <td>Order N=2~N=20, Gain limit 33.33%</td> </tr> <tr> <td style="background-color: #cccccc; padding: 2px;"></td> <td>Order N=21~N=30, Gain limit 30.00%</td> </tr> <tr> <td style="background-color: #cccccc; padding: 2px;"></td> <td>Order N=31~N=39, Gain limit 15.00%</td> </tr> </table>	<code>&lt;NR2&gt;...</code>	Effective rang	<code>&lt;NR2&gt;</code>	Order N=2~N=20, Gain limit 33.33%		Order N=21~N=30, Gain limit 30.00%		Order N=31~N=39, Gain limit 15.00%
<code>&lt;NR2&gt;...</code>	Effective rang								
<code>&lt;NR2&gt;</code>	Order N=2~N=20, Gain limit 33.33%								
	Order N=21~N=30, Gain limit 30.00%								
	Order N=31~N=39, Gain limit 15.00%								
	<pre>[[:SOURce]:SYNTHeSis:AMPLitude? 20.55 33.10 2.55</pre>								

**[[:SOURce]:SYNTHeSis:PHASe]** 
 →  
 →

Description	Set or query phase for each order of harmonic waveforms.				
Syntax	[[:SOURce]:SYNTHeSis:PHASe				
Query Syntax	[[:SOURce]:SYNTHeSis:PHASe?				
	<table border="0"> <tr> <td style="background-color: #cccccc; padding: 2px;"><code>&lt;NR2&gt;...</code></td> <td>Effective rang: 0.0 ~ 359.9</td> </tr> <tr> <td style="background-color: #cccccc; padding: 2px;"><code>&lt;NR2&gt;</code></td> <td></td> </tr> </table>	<code>&lt;NR2&gt;...</code>	Effective rang: 0.0 ~ 359.9	<code>&lt;NR2&gt;</code>	
<code>&lt;NR2&gt;...</code>	Effective rang: 0.0 ~ 359.9				
<code>&lt;NR2&gt;</code>					
	<pre>[[:SOURce]:SYNTHeSis:PHASe? 100.5 20.8 60.5 77.8</pre>				

## Other Commands

:TRIG .....	126
:NPHase.....	126
:INSTrument:NSElect 1 2 3.....	127
:VERion:DSP? .....	127
:VERion:LCM? .....	128
:VERion:UI?.....	128

### :TRIG

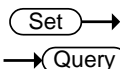

Description	Set or query trigger status. Disabled when OUTPut:MODE = FIXE.	
Syntax	:TRIG	
Query Syntax	:TRIG?	
Parameter	OFF	
	ON	
Return parameter	OFF	
	RUNNING	
Example	TRIG? TRIG ON	

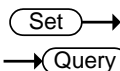

### :NPHase



Description	Set output mode. There are three settings. SINGLE : Outputs in single phase (parallel) THREE.SYN : Three phase output. Only phase 1 need to set voltage and frequency. Voltage and frequency of phase 2 and 3 changes according to setting of phase 1 THREE. INDIV : Three phase output. Voltage for three phase can be set independently.	
-------------	---	--

Syntax	:NPHase
Query Syntax	:NPHase?
Parameter/ Return parameter	SINGLE
	THREE.SYN
	THREE.INDIV
Example	:NPHase? :NPHase SINGLE  Query output mode set output as single phase

 **Note** It needs 800msec to make this command take effect, please reserve delay time to make sure operation normally.

 →  
 → 

**:INSTrument:NSElect 1|2|3**

Description	Set or query specific output phase for responding queries
Syntax	: INSTrument:NSElect
Query Syntax	:INSTrument:NSElect?
Parameter/ Return parameter	1
	2
Example	:INSTrument:NSElect? :INSTrument:NSElect 2  Query which phase is set for query. Query Φ2 status.

**:VERion:DSP?** → 

Description	Query firmware version.
Syntax	:VERion:DSP?
Return Parameter	S00E02

Example :VERion:DSP?  
S00E02

:VERion:LCM? → Query

Description Query firmware version used for LCM.

Syntax :VERion:LCM?

Return Parameter S00E02

Example :VERion:LCM?  
S00E02

:VERion:UI? → Query

Description Query firmware version of UI.

Syntax :VERion:UI?

Return Parameter S00E02

Example :VERion:UI?  
S00E02

:SYSTem:ERRor → Query

Description Query error status. It must be used together with command "INSTRument: NSElect"

Syntax :SYSTem: ERRor?

Return Parameter Return NORMAL for no errors.

Example :SYSTem:ERRor?



# A

## PPENDIX

---

Protection .....	130
Specifications .....	132
Certificate Of Compliance .....	136
TTL Pin Assignment.....	137
9-PIN D-SUB female connector.....	137
Remote Inhibit .....	137
AC-ON .....	137
FAULT-OUT .....	137
Built In Waveforms .....	138

## Protection

The ASD-1900 provide software and hardware protections. The ASD-1900 will cut off output relay to turn off output and display protection status on screen when protection happens. To resume the output, following three errors can be released by long press any key. For other errors, turn off AC source, make correction for abnormal load or wrong AC mains voltage, and turn on AC source again to resume output.

- Software OCP
- D2A OCP Fault
- D2A OPP Fault

Errors	Status description
DSP initial Fault	Error occurs when DSP doing initialization
EEPROM Fault	When memory has errors
I2C ERROR Fault	Internal communication abnormal
Remote sense Fault	Voltage compensation exceeds max/min limitation
Software OCP	Output current is over limitation (I Limit)
Software OVP	Output voltage is over limitation (V Limit)
State Machine Fault	Software process abnormal

### Protections by hardware

Errors	Status description
AUX PG Fault	AUX Power output abnormal
D2A IC Fault	Voltage/ current detection IC malfunction
D2A OCP Fault	Over current for D2D Board*
D2A OPP Fault	Over power for D2A Board
D2A OTP Fault	Over temperature for D2A Board
D2D OTP Fault	Over temperature for D2D Board
D2D PG Fault	Output abnormal for D2D Board

---

FAN Fault	Fan malfunction
Input OCP	Input current reaches trip point of built in no fuse breaker**
PFC AC Fault	AC mains voltage higher or lower than rating ranges
PFC OVP Fault	Over voltage for PFC Board
PFC OTP Fault	Over temperature for PFC Board
PFC PG Fault	Output abnormal for PFC Board

---

\* D2A OCP ranges: When Voltage Level is 300V, OCP trigger point is 48A. It is 96A when voltage Level is set at 150V.

\*\* ASD-1900 has one no fuse breaker at AC input side, its current rating is 20A. AC source will enter protection status when AC input current is over 20A.

## Specifications

The operation specifications of ASD-1900 programmable AC Power Source are listed below. All specifications have been tested according to the standard of Delta test procedures. All specifications are based on resistor load with remote sense connection, under  $25\pm 2^{\circ}\text{C}$  unless specified otherwise.

Input ratings (AC rms)		
Nominal input voltage	220Vac to 240 Vac (L-L)	
	3 $\phi$ 4 wire $\Delta$ connection	
	380 ~ 400 Vac (L-L)	
	3 $\phi$ 5 wire Y connection	
Input voltage range	190 Vac to 250 Vac (L-L)	
	3 $\phi$ 4 $\Delta$ connection	
	329 ~ 433 Vac (L-L)	
	3 $\phi$ 5 Y connection	
Phase	3 $\phi$ 4 wire, 3 $\phi$ 5 wire	
Nominal input Frequency	50 Hz to 60 Hz	
Input frequency range	47 Hz to 63 Hz	
Max. power consumption	$\leq 111250$ VA	
Power factor	0.98 Min.	
Max. input current	190Vac: 35A/Phase; 329Vac: 25A/Phase	
AC mode output ratings (AC rms)		
Voltage	Setting Range 0.0 V to 150.0 V 0.0 V to 300.0 V	
	Setting Resolution 0.1V	
	Accuracy $\pm (0.2 \% \text{ of set} + 0.3 \text{ V} / 0.6 \text{ V})$	
Output phase	Single phase, Three-wire	
Maximum current	150V	90A (Single phase)
		60A (Three phase)
	300V	15A (Single phase)
		15A (Three phase)

Maximum peak current	150V	270A (30Hz~100Hz) (Single phase) 90A (30Hz~100Hz) (Three phase) 225A (>100Hz~1kHz) (Single phase) 75A (>100Hz~1kHz) (Three phase)
	300V	135A (30Hz~100Hz) (Single phase) 45A (30Hz~100Hz) (Three phase) 113A (>100Hz~1kHz) (Single phase) 38A (>100Hz~1kHz) (Three phase)
Load power factor	0 to 1(leading phase or lagging phase)	
Power capacity	3000 VA	
Frequency	Setting range	AC Mode: 30.0 Hz to 1000.0 Hz,
	Setting resolution	0.1 Hz (30.0 to 1000.0 Hz)
	Accuracy	0.15%
Output on phase	0.0° to 359.9° variable (setting resolution 0.1°)	
Output voltage stability		
Line regulation	0.1%	
Load regulation	0.2%(in series) ; 0.8% (in parallel)	
Output voltage waveform distortion ratio, Output voltage response time, Efficiency		
Output voltage waveform distortion ratio	≤ 1%	
Output voltage response time	100 us (TYP)	
Efficiency	80 % typ. At full load	
Measured value display		
Voltage	RMS, AVG value Resolution	0.1 V
	PEAK value Resolution	0.1 V
Current	RMS, AVG value Resolution	0.01 A
	PEAK value Resolution	0.01 A
Power	Active (W) Resolution	0.1W
	Apparent (VA) Resolution	0.1 VA

	Reactive (VAR) Resolution	0.1 VAR
Load power factor	Range	0.000 to 1.000
	Resolution	0.001
Load crest factor	Range	1.2 to 1.414
	Resolution	0.001
Harmonic voltage	Range	Up to 39th order of the fundamental wave
<b>Others</b>		
Protections	UVP, OCP, OPP, SCP, OTP, FAN FAIL	
Display	STN-LCD, 6 inch	
Memory Function	Store and recall settings, Basic settings: 4 (0~3 numeric keys)	
Arbitrary Wave Number of memories	30 (nonvolatile)	
<b>General Specifications</b>		
Interface	GPIB	IEEE 488.2 compliant interface
	RS-232C	Complies with the EIA-RS-232 specifications
	EXT Control	External Control I/O
Withstand voltage	Between input and chassis, output and chassis, input and output	2210 Vac, 1 minute
EMC	EN 61326-1	
	EN 61326-2-2	
	EN 61000-3-2 (Class D)	
	EN 61000-3-3	
	EN 61000-4-2/-4-3/-4-4/-4-5/-4-6/-4-8/-4-11 (Class A, Group 1)	
	EN 55011 (Class A, Group1)	
Safety	EN 61010-1	
Environment	Operating environment	Indoor use, Overvoltage Category II

Operating temperature range	0 °C to 40 °C
Storage temperature range	-40 °C to 85 °C
Storage humidity range	90 % RH or less (no condensation)
Altitude	Up to 2000 m
Dimensions (mm)	546(W) × 700(H) × 1025(D)
Weight	153kg

## Certificate Of Compliance

We

**GOOD WILL INSTRUMENT CO., LTD.**

declare that the CE marking mentioned product

satisfies all the technical relations application to the product within the scope of council:

Directive: EMC; LVD; WEEE; RoHS

The product is in conformity with the following standards or other normative documents:

© EMC	
EN 61326-1	Electrical equipment for measurement, control and laboratory use -- EMC requirements
Conducted & Radiated Emission EN 55011 / EN 55032	Electrical Fast Transients EN 61000-4-4
Current Harmonics EN 61000-3-2 / EN 61000-3-12	Surge Immunity EN 61000-4-5
Voltage Fluctuations EN 61000-3-3 / EN 61000-3-11	Conducted Susceptibility EN 61000-4-6
Electrostatic Discharge EN 61000-4-2	Power Frequency Magnetic Field EN 61000-4-8
Radiated Immunity EN 61000-4-3	Voltage Dip/ Interruption EN 61000-4-11 / EN 61000-4-34
© Safety	
EN 61010-1 :	Safety requirements for electrical equipment for measurement, control, and laboratory use - Part 1: General requirements

**GOODWILL INSTRUMENT CO., LTD.**

No. 7-1, Jhongsing Road, Tucheng District, New Taipei City 236, Taiwan

Tel: [+886-2-2268-0389](tel:+886-2-2268-0389)

Fax: [+886-2-2268-0639](tel:+886-2-2268-0639)

Web: <http://www.gwinstek.com> Email: [marketing@goodwill.com.tw](mailto:marketing@goodwill.com.tw)

**GOODWILL INSTRUMENT (SUZHOU) CO., LTD.**

No. 521, Zhujiang Road, Snd, Suzhou Jiangsu 215011, China

Tel: [+86-512-6661-7177](tel:+86-512-6661-7177)

Fax: [+86-512-6661-7277](tel:+86-512-6661-7277)

Web: <http://www.instek.com.cn> Email: [marketing@instek.com.cn](mailto:marketing@instek.com.cn)

**GOODWILL INSTRUMENT EURO B.V.**

De Run 5427A, 5504DG Veldhoven, The Netherlands

Tel: [+31-\(0\)40-2557790](tel:+31-(0)40-2557790)

Fax: [+31-\(0\)40-2541194](tel:+31-(0)40-2541194)

Email: [sales@gw-instek.eu](mailto:sales@gw-instek.eu)



## TTL Pin Assignment

### 9-PIN D-SUB female connector

Pin number 1	2	3	4		
Signal	GND	Remote inhibit	GND	AC-ON	
Pin number 5	6	7	8	9	
Signal	---	GND	GND	FAULT-OUT	---

### Remote Inhibit

- OFF: Disable remote inhibit output function.
- LIVE: AC source will turn off (turn on) output when TTL signal is low (high).
- TRIG: When TTL signal changed from HIGH → LOW, and keep at low status longer than 1ms, output will be turned off and stop detecting TTL signal. User must press **OUT** key to resume output and enable TTL detection.
- EXCITE: In operation of LIST, PULSE or STEP modes, when at triggering page (please refer to section **LIST Mode** until **STEP Mode** on page 70 for details), AC source output will be triggered on/off by positive edge TTL trigger signal (LOW → HIGH). Pulse signal must stay at high level at least 1ms.

### AC-ON

HIGH (LOW) level when AC source output status is ON/OFF.

### FAULT-OUT

LOW (HIGH) when AC source is in normal (protection status due to error)

# Built In Waveforms

## DST 0

Order	Gain	Phase
2	2.07	0.0
5	9.80	0.0
7	15.80	0.0
8	2.16	0.0

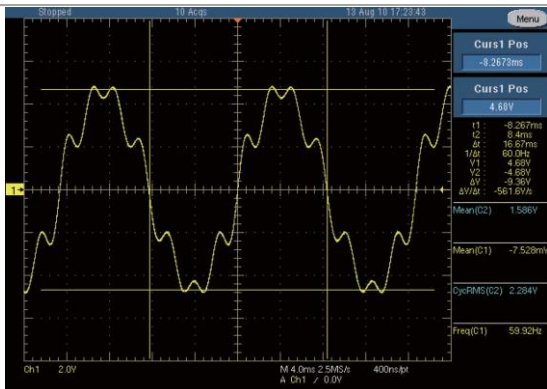

## DST 1

Order	Gain	Phase
3	1.50	0.0
7	1.50	0.0
19	2.00	0.0

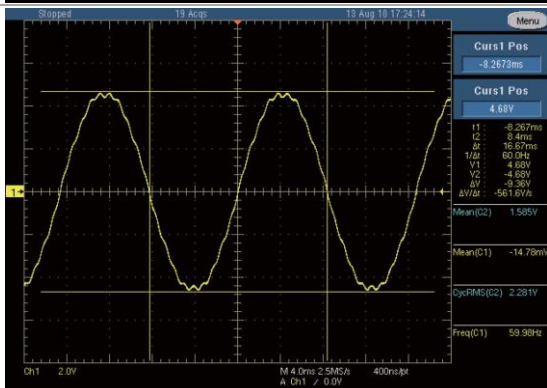

## DST 2

Order	Gain	Phase
3	2.00	0.0
5	1.40	0.0
7	2.00	0.0
23	1.40	0.0
31	1.00	0.0

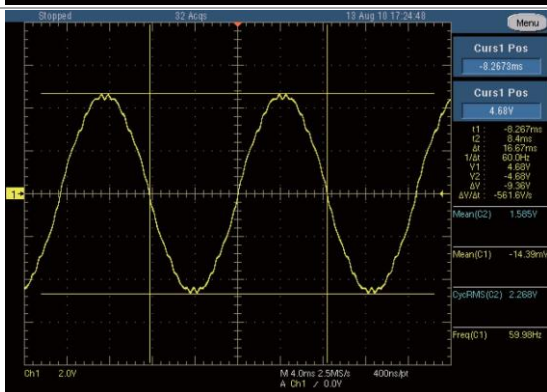

**DST 3**

Order	Gain	Phase
3	2.50	0.0
5	1.90	0.0
7	2.50	0.0
23	1.90	0.0
25	1.10	0.0
31	1.50	0.0
33	1.10	0.0

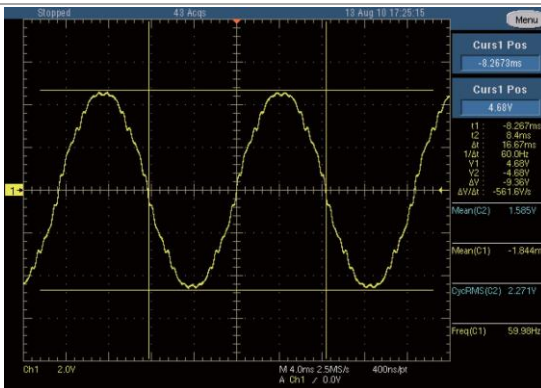

**DST 4**

Order	Gain	Phase
3	1.10	0.0
5	2.80	0.0
7	1.40	0.0
9	2.30	0.0
11	1.50	0.0

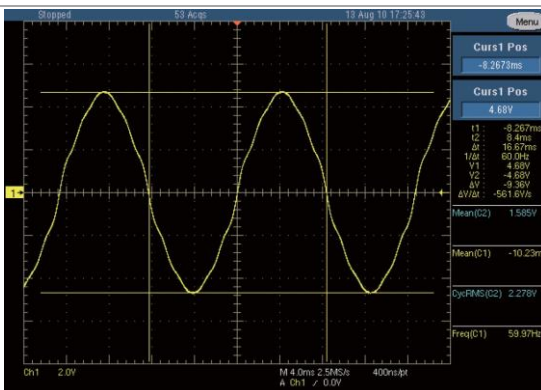

**DST 5**

Order	Gain	Phase
3	1.65	0.0
5	4.20	0.0
7	3.45	0.0
15	1.05	0.0
19	3.00	0.0

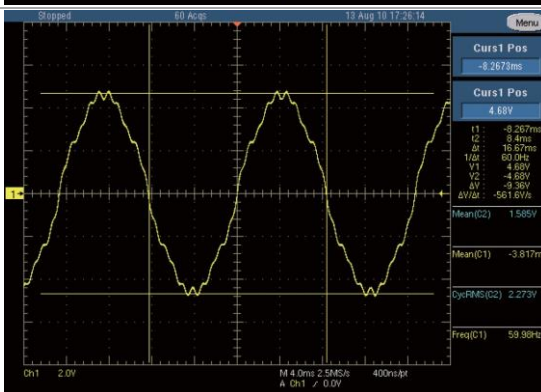

**DST 6**

Order	Gain	Phase
3	2.20	0.0
5	5.60	0.0
7	2.80	0.0
9	4.60	0.0
11	3.00	0.0
15	1.40	0.0
21	1.00	0.0

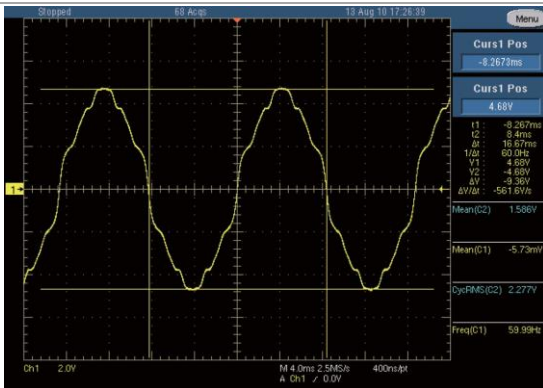

**DST 7**

Order	Gain	Phase
3	4.90	0.0
5	1.60	0.0
7	2.70	0.0
11	1.40	0.0
15	2.00	0.0
17	1.10	0.0

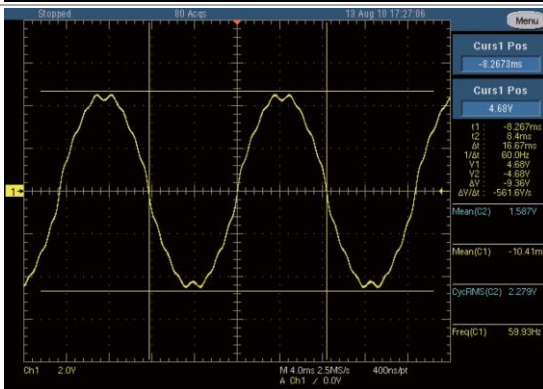

**DST 8**

Order	Gain	Phase
3	7.35	0.0
5	2.40	0.0
7	4.05	0.0
11	2.10	0.0
13	1.05	0.0
15	3.00	0.0
17	1.65	0.0
19	1.05	0.0
21	1.05	0.0
23	1.20	0.0
25	1.05	0.0

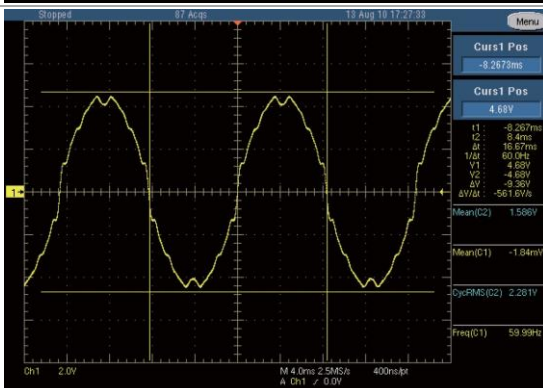

**DST 9**

Order	Gain	Phase
3	9.80	0.0
5	3.20	0.0
7	5.40	0.0
9	1.20	0.0
11	2.80	0.0
13	1.40	0.0
15	4.00	0.0
17	2.20	0.0
19	1.40	0.0
21	1.40	0.0
23	1.60	0.0
25	1.40	0.0

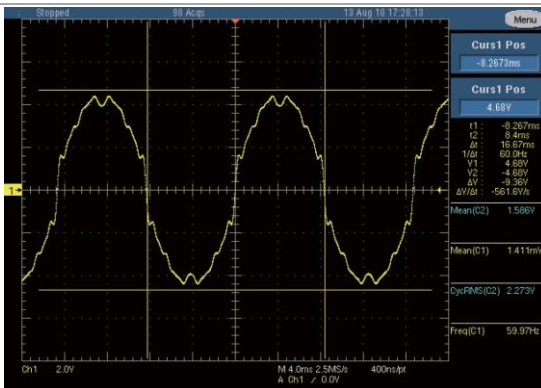

**DST 10**

Order	Gain	Phase
3	17.75	0.0

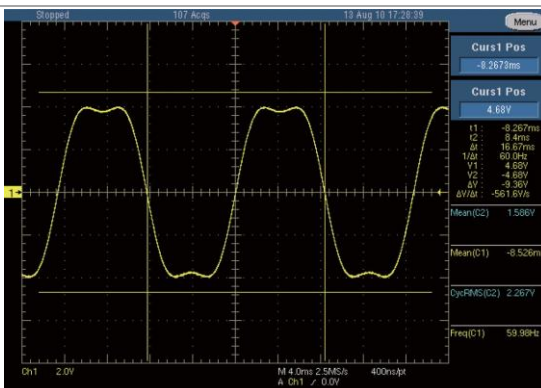

**DST 11**

Order	Gain	Phase
3	21.25	0.0

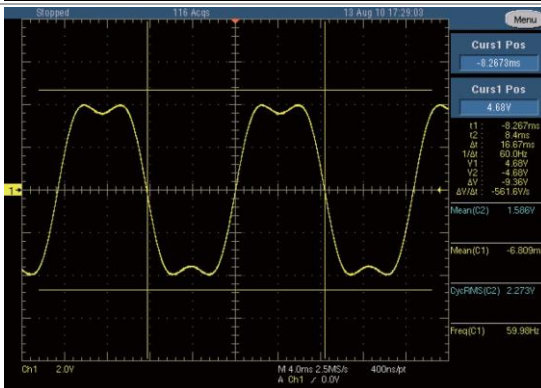

**DST 12**

Order	Gain	Phase
3	24.50	0.0

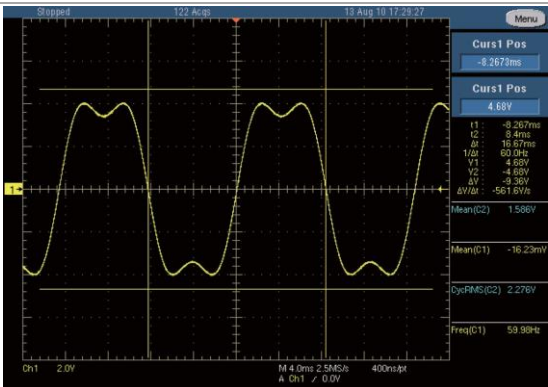

**DST 13**

Order	Gain	Phase
2	2.30	0.0
5	9.80	0.0
7	15.80	0.0
8	2.50	0.0

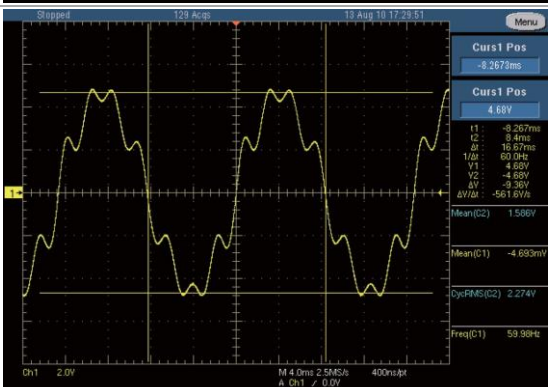

**DST 14**

Order	Gain	Phase
2	1.15	0.0
5	4.90	0.0
7	7.90	0.0
8	1.25	0.0

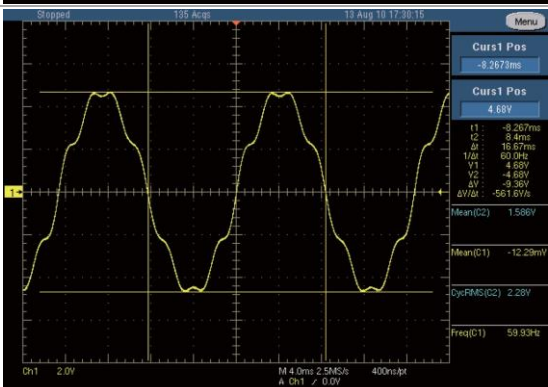

**DST 15**

Order	Gain	Phase
5	1.15	0.0
7	4.90	0.0

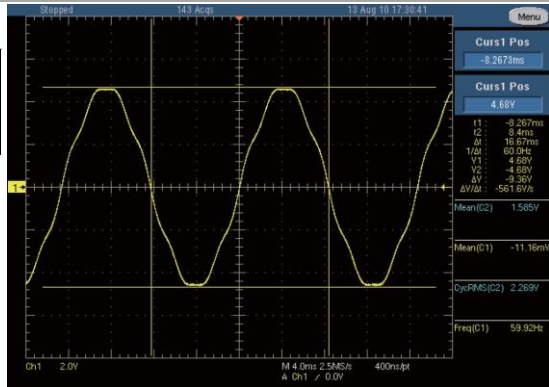

**DST 16**

Order	Gain	Phase
3	11.00	180.0
5	4.05	0.0
7	2.00	180.0
9	1.30	0.0

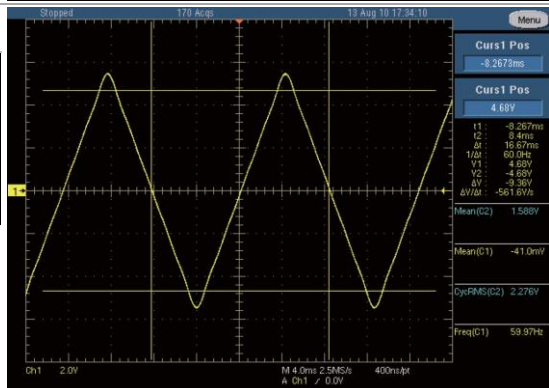

**DST 17**

Order	Gain	Phase
3	7.17	0.0
5	3.42	180.0
9	0.80	0.0

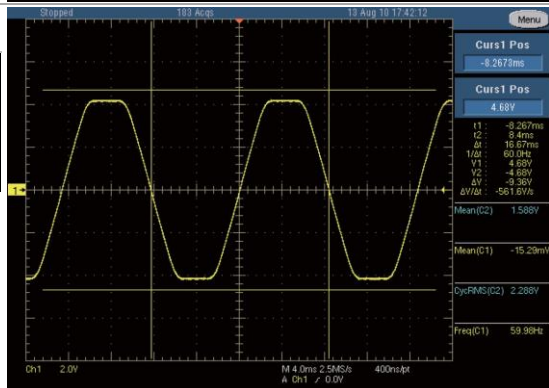

**DST 18**

Order	Gain	Phase
3	8.11	0.0
5	3.48	180.0
9	1.00	0.0

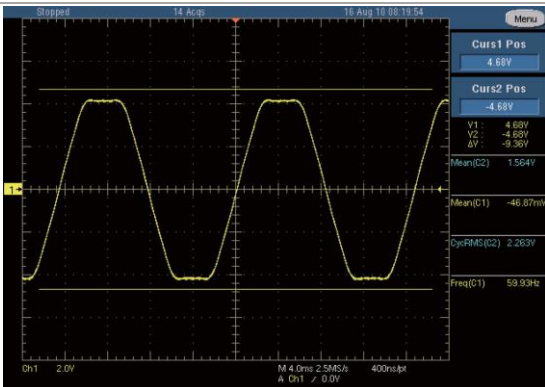

**DST 19**

Order	Gain	Phase
3	9.38	0.0
5	3.44	180.0
9	1.15	0.0

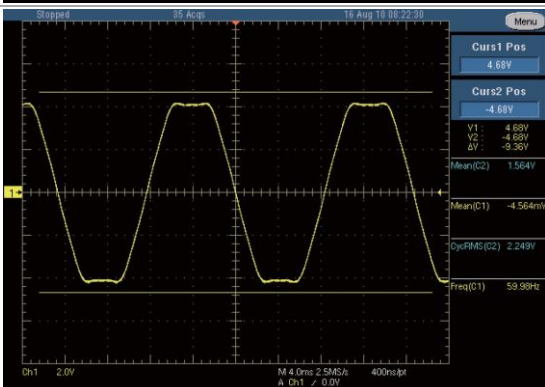

**DST 20**

Order	Gain	Phase
3	2.06	180.0
5	1.77	0.0
7	1.62	180.0
9	1.23	0.0
11	0.91	180.0
13	0.54	0.0
23	0.51	0.0
25	0.53	180.0

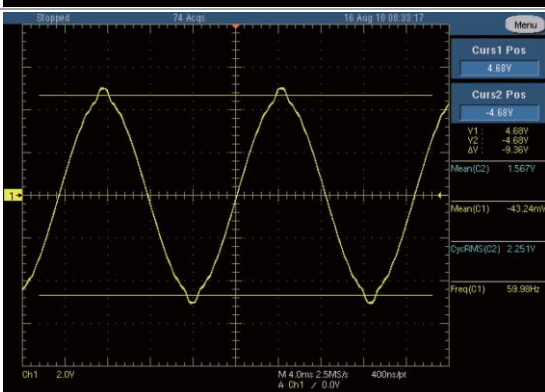



**DST 21**

Order	Gain	Phase
3	3.08	180.0
5	2.72	0.0
7	2.43	180.0
9	1.97	0.0
11	1.41	180.0
13	0.86	0.0
21	0.62	180.0
23	0.73	0.0
25	0.77	180.0
27	0.69	0.0
29	0.56	180.0

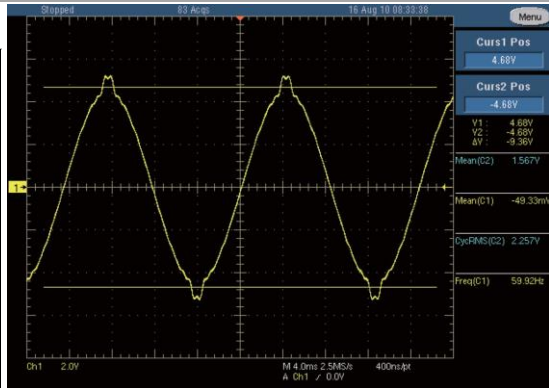

**DST 22**

Order	Gain	Phase
2	0.13	180.0
3	4.28	180.0
5	3.77	0.0
7	3.27	180.0
9	2.57	0.0
11	1.93	180.0
13	1.22	0.0
15	0.55	180.0
19	0.46	0.0
21	0.83	180.0
23	0.97	0.0
25	1.04	180.0
29	0.75	180.0

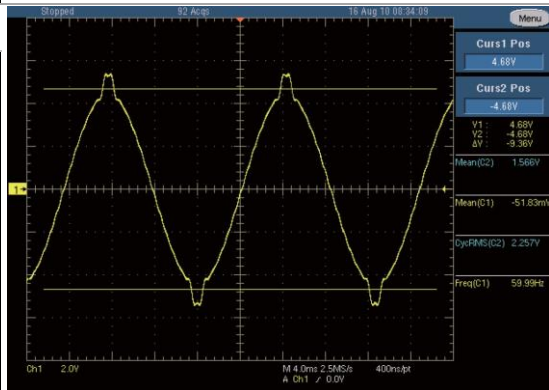

**DST 23**

Order	Gain	Phase
3	5.74	180.0
5	5.11	0.0
7	4.44	180.0
9	3.52	0.0
11	2.63	180.0
13	1.65	0.0
15	0.8	180.0
19	0.61	0.0
21	1.07	180.0
23	1.28	0.0
25	1.35	180.0
27	1.22	0.0
29	0.98	180.0

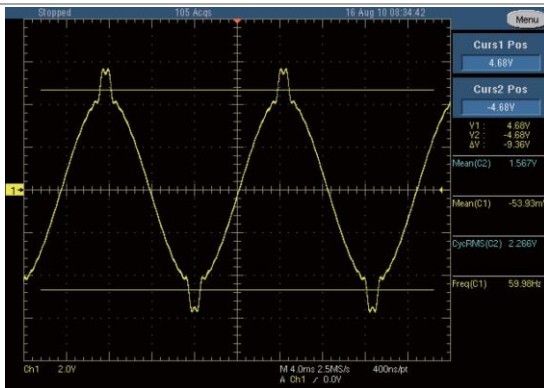

**DST 24**

Order	Gain	Phase
3	7.35	180.0
5	6.60	0.0
7	5.74	180.0
9	4.57	0.0
11	3.41	180.0
13	2.16	0.0
15	1.04	180.0
19	0.74	0.0
21	1.35	180.0
23	1.64	0.0
25	1.73	180.0
27	1.56	0.0
29	1.24	180.0

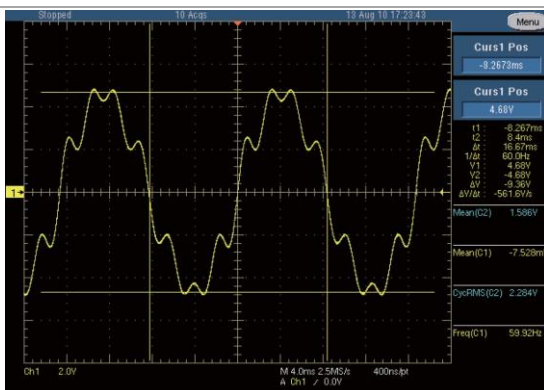

**DST 25**

Order	Gain	Phase
5	3.41	0.0
7	2.55	0.0
11	9.22	0.0
13	7.68	0.0
17	0.90	0.0
19	0.90	0.0
23	3.88	0.0
25	3.56	0.0
31	0.50	0.0
35	2.34	0.0
37	2.21	0.0

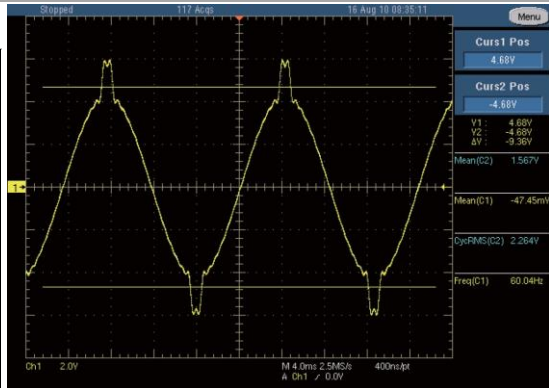

**DST 26**

Order	Gain	Phase
21	1.38	0.0
23	5.39	0.0
25	2.29	0.0

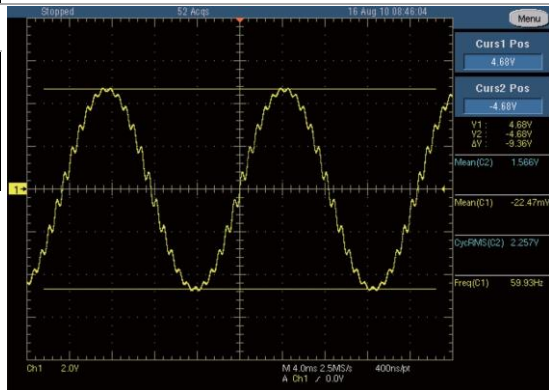

DST 27

Order	Gain	Phase
3	33.33	0.0
5	20.00	0.0
7	13.80	0.0
9	10.80	0.0
11	8.50	0.0
13	7.20	0.0
15	6.00	0.0
17	5.00	0.0
19	5.00	0.0
21	4.50	0.0
23	4.00	0.0
25	3.50	0.0
27	2.95	0.0
29	2.50	0.0
31	2.00	0.0
33	2.00	0.0
35	2.00	0.0
37	2.00	0.0
39	2.00	0.0

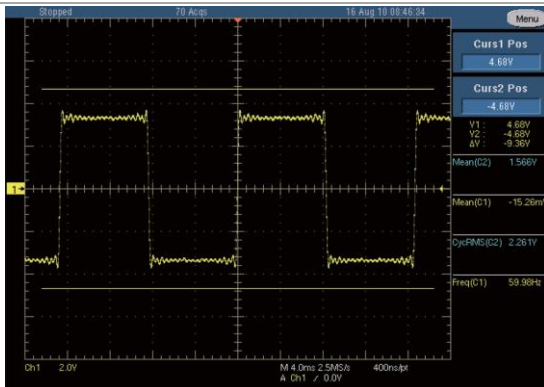

DST 28

Order	Gain	Phase
3	33.33	0.0
5	20.00	0.0
7	13.80	0.0
9	10.80	0.0
11	8.50	0.0
13	7.20	0.0
15	6.00	0.0
17	5.00	0.0
19	5.00	0.0
21	4.50	0.0
23	4.00	0.0
25	1.00	0.0
27	1.00	0.0
29	1.00	0.0
31	1.00	0.0
33	1.00	0.0
35	1.00	0.0
37	1.00	0.0
39	1.00	0.0

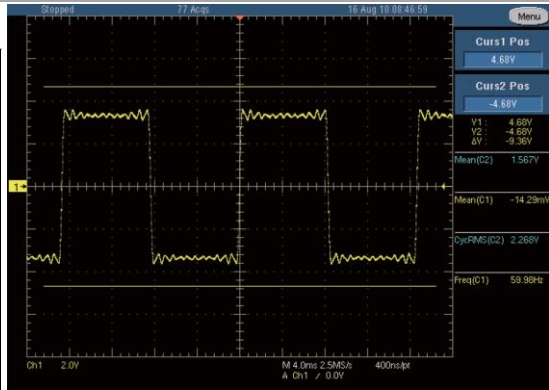

DST 29

Order	Gain	Phase
3	33.33	0.0
5	20.00	0.0
7	13.80	0.0
9	10.80	0.0
11	8.50	0.0
13	7.20	0.0
15	5.50	0.0

