

# DC Electronic Load

PEL-3000A/AH Series

---

## USER MANUAL

VERSION: 2.00



ISO-9001 CERTIFIED MANUFACTURER

**GW INSTEK**

This manual contains proprietary information, which is protected by copyright. All rights are reserved. No part of this manual may be photocopied, reproduced or translated to another language without prior written consent of Good Will company.

The information in this manual was correct at the time of printing. However, Good Will continues to improve products and reserves the rights to change specification, equipment, and maintenance procedures at any time without notice.

**Good Will Instrument Co., Ltd.**  
**No. 7-1, Jhongsing Rd., Tucheng Dist., New Taipei City 236, Taiwan.**

# Table of Contents

<b>SAFETY INSTRUCTIONS</b> .....	<b>3</b>
<b>GETTING STARTED</b> .....	<b>9</b>
PEL-3000A/AH Series Introduction .....	11
Accessories.....	13
Appearance.....	16
First Time Use Instructions .....	27
<b>OPERATION</b> .....	<b>53</b>
Basic Operation .....	56
Basic Configuration .....	68
Advanced Configuration Settings .....	75
Step Resolution Configuration .....	82
Protection Settings .....	85
System Settings .....	94
Go-NoGo .....	100
Save Recall .....	103
<b>FUNCTION MENU</b> .....	<b>116</b>
Function Menu Overview .....	117
Program .....	123
Sequence .....	131
OCP Test Automation .....	150
OPP Test Automation .....	157
BATT Test Automation .....	164
MPPT.....	172
<b>EXTERNAL CONTROL</b> .....	<b>185</b>
Analog Control .....	186
Parallel Operation.....	209

<b>REMOTE CONTROL</b> .....	<b>216</b>
Interface Configuration .....	217
<b>FAQ</b> .....	<b>245</b>
<b>APPENDIX</b> .....	<b>247</b>
Replacing the Dust Filter .....	249
Replace the Clock Battery.....	250
GPIB Installation .....	251
PEL-3000A/AH Default Settings .....	252
Frame Control Connector Contacts .....	255
Operating Mode Description .....	261
Operating Area .....	266
PEL-3000A Specifications.....	273
PEL-3000AH Specifications.....	285
PEL-3000A/AH Dimensions .....	297
Certificate Of Compliance .....	300
<b>INDEX</b> .....	<b>301</b>

# S SAFETY INSTRUCTIONS

This chapter contains important safety instructions that you must follow during operation and storage. Read the following before any operation to insure your safety and to keep the instrument in the best possible condition.

## Safety Symbols

These safety symbols may appear in this manual or on the instrument.



WARNING

Warning: Identifies conditions or practices that could result in injury or loss of life.

Avertissement : Identifie les conditions ou les pratiques qui pourraient entraîner des blessures ou la mort.



CAUTION

Caution: Identifies conditions or practices that could result in damage to the instrument or to other properties.

Attention : Identifie les conditions ou les pratiques qui pourraient entraîner des dommages à l'instrument ou à d'autres propriétés.



Danger High Voltage  
Danger haute tension



Attention Refer to the Manual  
Attention Référez-vous au manuel



Earth (ground) Terminal  
Borne de terre (masse)



Frame or Chassis Terminal  
Terminal de cadre ou de châssis



Do not dispose electronic equipment as unsorted municipal waste. Please use a separate collection facility or contact the supplier from which this instrument was purchased.

Ne jetez pas les équipements électroniques avec les déchets municipaux non triés. Veuillez utiliser une installation de collecte séparée ou contacter le fournisseur auprès duquel cet instrument a été acheté.

## Safety Guidelines

---

### General Guideline



#### CAUTION

- Do not place any heavy object on the instrument. Note: Only 2 units can be stacked vertically.  
Ne placez aucun objet lourd sur l'instrument. Remarque: Seules 2 unités peuvent être empilées verticalement.
- Avoid severe impact or rough handling that leads to damaging the instrument.  
Évitez les chocs violents ou les manipulations brusques qui pourraient endommager l'instrument.
- Do not discharge static electricity to the instrument.  
Ne déchargez pas d'électricité statique sur l'instrument.
- Use only crimped wires, not bare wires, for the terminals.  
Utilisez uniquement des fils sertis, et non des fils nus, pour les bornes.
- The fans cool the DC electronic load by drawing air in from the front and exhausting it out the back. To ensure proper airflow, the equipment should maintain sufficient cooling air convection or have at least 100 cm of clearance at both the front and back for adequate air circulation.  
Les ventilateurs refroidissent la charge électronique CC en aspirant l'air par l'avant et en l'évacuant par l'arrière. Pour assurer une bonne circulation d'air, l'équipement doit maintenir une convection d'air de refroidissement suffisante ou disposer d'un espace libre d'au moins 100 cm à l'avant et à l'arrière pour une circulation d'air adéquate.

- Do not block the cooling fan opening.  
Ne bloquez pas l'ouverture du ventilateur de refroidissement.
- Do not disassemble the instrument unless you are qualified.  
Ne démontez pas l'instrument à moins d'être qualifié.
- The equipment is not for measurements performed for CAT II, III and IV.  
L'équipement n'est pas destiné aux mesures effectuées pour CAT II, III et IV.
- Do NOT replace the detachable MAINS supply cord by inadequately RATED cords.  
Ne remplacez PAS le cordon d'alimentation secteur amovible par des cordons de calibre inadéquat.
- A suitable supply cord set shall be used with the equipment:
  - Mains plug: Shall be national approval;
  - Mains connector: C13 type;
  - Cable:
    - 1) Length of power supply cord: less than 3 m;
    - 2) Cross-section of conductors: at least 0.75 mm<sup>2</sup>;
  - Cord type: Shall meet the requirements of IEC 60227 or IEC 60245 (e.g.: H05VV-F, H05RN-F) or national approval.Un jeu de cordons d'alimentation approprié doit être utilisé avec l'équipement:
  - Prise secteur : Doit être approuvée au niveau national ;
  - Connecteur secteur : type C13 ;
  - Câble:
    - 1) Longueur du cordon d'alimentation : moins de 3 m;
    - 2) Section des conducteurs : au moins 0,75 mm<sup>2</sup> ;
  - Type de cordon : doit répondre aux exigences



de la norme CEI 60227 ou CEI 60245 (par exemple : H05VV-F, H05RN-F) ou à l'approbation nationale.

## Power Supply



## WARNING

- AC Input voltage range: 100-120VAC/200-240VAC (Max. 90-132VAC/180-250VAC)  
Plage de tension d'entrée CA: 100-120VAC/200-240VAC (maximum 90-132VAC/180-250VAC)
- Frequency: 47-63Hz  
Fréquence: 47-63 Hz
- Power:  
PEL-3021A/AH: 90VA Max.  
PEL-3041A/AH: 110VA Max.  
PEL-3111A/AH: 190VA Max.  
PEL-3211A/AH: 230VA Max.  
Pouvoir:  
PEL-3021A/AH: 90 VA maximum  
PEL-3041A/AH: 110 VA maximum  
PEL-3111A/AH: 190 VA maximum  
PEL-3211A/AH: 230 VA maximum
- To avoid electrical shock connect the protective grounding conductor of the AC power cord to an earth ground.  
Pour éviter tout choc électrique, connectez le conducteur de mise à la terre de protection du cordon d'alimentation secteur à une prise de terre.
- To avoid electric shock, the power cord protective grounding conductor must be connected to ground. No operator serviceable components inside. Do not remove covers. Refer servicing to qualified personnel.  
Pour éviter les chocs électriques, le conducteur de mise à la terre du cordon d'alimentation doit être connecté à la terre. Aucun composant réparable par l'opérateur à l'intérieur. Ne retirez pas les couvercles. Confiez l'entretien à un personnel qualifié.

- |          |  |
|----------|--|
| Cleaning | <ul style="list-style-type: none"> <li>• Disconnect the power cord before cleaning.</li> <li>• Use a soft cloth dampened in a solution of mild detergent and water. Do not spray any liquid.</li> <li>• Do not use chemicals containing harsh material such as benzene, toluene, xylene, and acetone.</li> </ul> |
|----------|--|

- |                       |  |
|-----------------------|--|
| Operation Environment | <ul style="list-style-type: none"> <li>• Location: Indoor, no direct sunlight, dust free, almost non-conductive pollution (Note below)</li> <li>• Temperature: 0°C to 40°C</li> <li>• Humidity: 0 to 85% RH</li> <li>• Altitude: &lt;2000m</li> <li>• Overvoltage category II</li> </ul> |
|-----------------------|--|

(Pollution Degree) EN 61010-1 specifies the pollution degrees and their requirements as follow. The instrument falls under degree 2.

Pollution refers to “addition of foreign matter, solid, liquid, or gaseous (ionized gases), that may produce a reduction of dielectric strength or surface resistivity”.

- Pollution degree 1: No pollution or only dry, non-conductive pollution occurs. The pollution has no influence.
- Pollution degree 2: Normally only non-conductive pollution occurs. Occasionally, however, a temporary conductivity caused by condensation must be expected.
- Pollution degree 3: Conductive pollution occurs, or dry, non-conductive pollution occurs which becomes conductive due to condensation which is expected. In such conditions, equipment is normally protected against exposure to direct sunlight, precipitation, and full wind pressure, but neither temperature nor humidity is controlled.

- |                     |  |
|---------------------|--|
| Storage environment | <ul style="list-style-type: none"> <li>• Location: Indoor</li> <li>• Temperature: -20°C to 70°C</li> <li>• Humidity: &lt;90% RH</li> </ul> |
|---------------------|--|

**Disposal**



Do not dispose this instrument as unsorted municipal waste. Please use a separate collection facility or contact the supplier from which this instrument was purchased. Please make sure discarded electrical waste is properly recycled to reduce environmental impact.

# G E T T I N G   S T A R T E D

This chapter provides a brief overview of the PEL-3000A/AH, the package contents, instructions for first time use and an introduction to the front panel, rear panel and GUI.



<b>PEL-3000A/AH Series Introduction .....</b>	<b>11</b>
Model Line Up .....	11
Main Features .....	12
<b>Accessories .....</b>	<b>13</b>
Package Contents .....	15
<b>Appearance .....</b>	<b>16</b>
Front Panel .....	16
PEL-3021A/ PEL-3041A .....	16
PEL-3021AH/ PEL-3041AH .....	16
PEL-3111A .....	17
PEL-3111AH .....	17
PEL-3211A/AH Booster Pack .....	17
Rear Panel .....	21
PEL-3021A/ PEL-3041A .....	21
PEL-3021AH/ PEL-3041AH .....	21
PEL-3111A .....	22

PEL-3211AH Booster Pack .....	23
Display .....	26
<b>First Time Use Instructions .....</b>	<b>27</b>
Rack Mount Kits .....	27
Power Up and Self Test .....	30
Load Default Settings .....	30
Setting the Date and Time .....	31
Load Wiring .....	33
Load Wire Connections .....	36
Using the Front Panel Input Terminals .....	37
Using the Rear Panel Input Terminals .....	38
Using the Terminal Cover (PEL-011) .....	39
Using the Terminal Cover (PEL-013) .....	41
Using the Terminal Cover .....	42
Using the Monitor Out Cover (Only for PEL-3021AH, PEL-3041AH, PEL-3111AH) .....	43
Remote Sense .....	44
Firmware Update .....	45
Conventions .....	47
Help Menu .....	52

## PEL-3000A/AH Series Introduction

The PEL-3000A/AH Series is a family of high performance DC electronic loads positioned to test a wide range of different power sources. The DC electronic loads are fully programmable to simulate anything from basic static loads to complex dynamic loads. With the ability to operate independently or in parallel, the PEL-3000A/AH Series is extremely robust and capable of molding to any test environment.

Please note that throughout this manual the term “PEL-3000A/AH” refers to any one of the models in the series lineup, unless specifically stated otherwise.

### Model Line Up

There are a total of 3 DC electronic load models and 1 booster pack model.

Model	Voltage (DC)	Current	Power
PEL-3021 A/AH	0V-150V(0V-800V)	35A(8.75A)	175W
PEL-3041 A/AH	0V-150V(0V-800V)	70A(17.5A)	350W
PEL-3111 A/AH	0V-150V(0V-800V)	210A(52.5A)	1050W
Booster Model	Voltage (DC)	Current	Power
PEL-3211A/AH	0V-150V(0V-800V)	420A(105A)	2100W

## Main Features

---

- |             |  |
|-------------|--|
| Performance | <ul style="list-style-type: none"><li>• High slew rates of up to 16A/<math>\mu</math>S (PEL-3111A/AH) for a fast response speed</li><li>• High capacity when used in parallel: 5250W, 1050A(262.5A) (PEL-3111A/AH x 5)/ 9450W, 1890A(472.5A) (PEL-3111A/AH + PEL-3211A/AH x 4)</li><li>• High resolution - 16 bit</li></ul>  |
| Features    | <ul style="list-style-type: none"><li>• 7 operating modes: CC, CV, CR, CP, CC+CV, CR+CV, CP+CV</li><li>• Independent and parallel operation</li><li>• Fully programmable with normal and fast sequences</li><li>• Soft start</li><li>• Dynamic mode</li><li>• OCP, OVP and other protection features</li><li>• Remote sense</li><li>• Integrated meter</li><li>• Rack-mountable</li><li>• Load booster</li></ul> |
| Interface   | <ul style="list-style-type: none"><li>• USB, RS232/485, LAN and GPIB(option)</li><li>• External voltage or resistance control</li><li>• Front panel trigger out BNC</li><li>• Front panel voltage/current monitoring BNC</li><li>• Analog external control</li><li>• Rear panel voltage/current monitoring</li></ul>   |

## Accessories

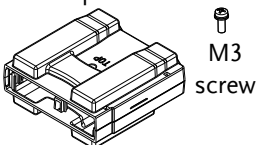
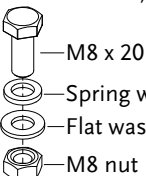
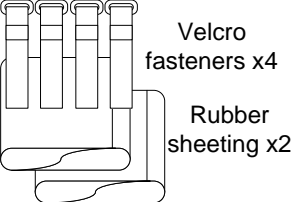
Standard Accessories	Part number	Description
		Quick Start Guide
		User / Programming manual CD
	Region dependent	Power cord
	PEL-011	Load input terminal Cover 
	PEL-012	Terminal fittings: 2 sets of bolts/nuts/springs/washers (type: M8), Terminal Cover x1 (only for PEL-3000AH series), Monitor Out Cover x 1 (only for PEL-3021AH, PEL-3041AH, PEL-3111AH) 
	PEL-013	Flexible terminal cover: 2x rubber sheeting, 4x Velcro fasteners. (For PEL-3211A/AH only) 

PEL-014 J1/J2 Protection plug x2 (It is installed on the device)



61SF-062104N1 Front terminal washers  
—Spring washer (M6) x2

GTL-255 300mm Frame Link Cable (for linking units that are stacked). Note that this accessories is optional for the PEL-3021A/AH or 3041A/AH.

Optional Accessories	Part number	Description
----------------------	-------------	-------------

	3813-030D0501	CR123A 3V lithium battery for clock.
--	---------------	--------------------------------------

	GRA-413-E	Rack mount bracket for booster PEL-3211A/AH (EIA)
--	-----------	---

	GRA-413-J	Rack mount bracket for booster PEL-3211A/AH (JIS)
--	-----------	---

	GRA-414-E	Rack mount frame for PEL-3021A/AH, PEL-3041A/AH, PEL-3111A/AH/EIA
--	-----------	---

	GRA-414-J	Rack mount frame for PEL-3021A/AH, PEL-3041A/AH, PEL-3111A/AH/JIS
--	-----------	---

	GTL-248	GPIB cable, 2.0m
--	---------	------------------

	GTL-246	USB cable, Type A - Type B
--	---------	----------------------------

	PEL-010	Dust Filter
--	---------	-------------

	PEL-004	GPIB card
--	---------	-----------

	PEL-005	Connect Cu Plate
--	---------	------------------

	PEL-006	Connect Cu Plate
--	---------	------------------

	PEL-007	Connect Cu Plate
--	---------	------------------

	PEL-008	Connect Cu Plate
--	---------	------------------

	PEL-009	Connect Cu Plate
--	---------	------------------



GTL-259	RS232 cable with DB9 connector to RJ45
GTL-260	RS485 cable with DB9 connector to RJ45
GTL-261	Serial Master Cable + Terminator, 0.5M
GTL-262	RS-485 Slave cable

## Package Contents

Check the contents before using the instrument.

---

### Opening the box

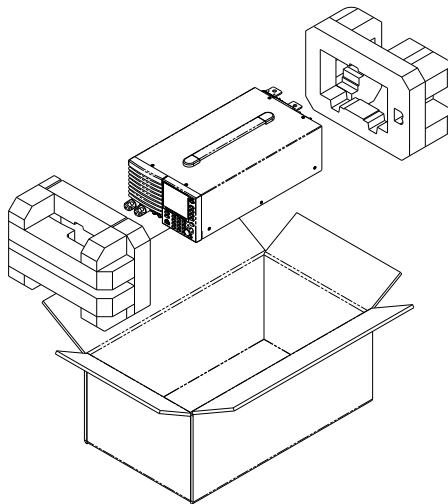

Contents  
(single unit)

- Main unit
- Quick Start manual
- Calibration certificate
- Terminal fittings
- Power cord x1  
(region dependent)

# Appearance

## Front Panel

### PEL-3021A/ PEL-3041A

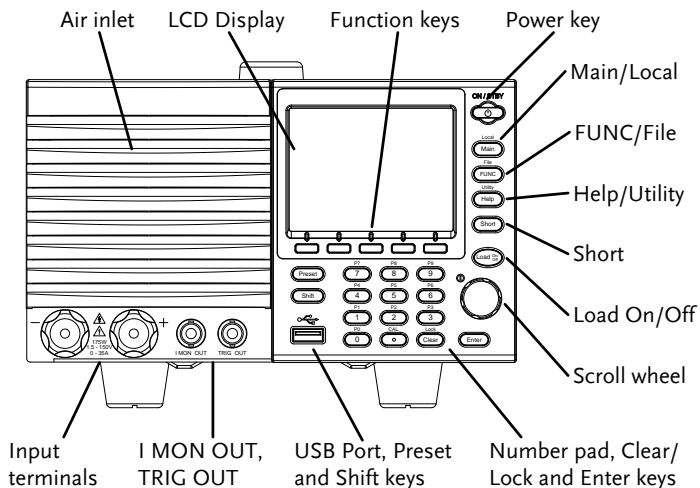

### PEL-3021AH/ PEL-3041AH

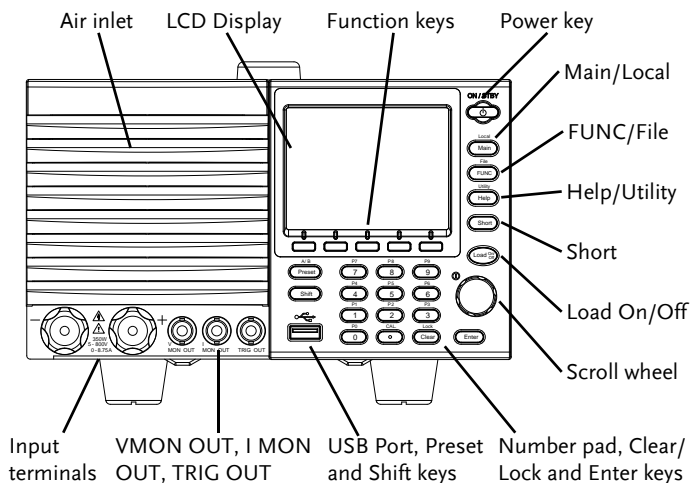

PEL-3111A

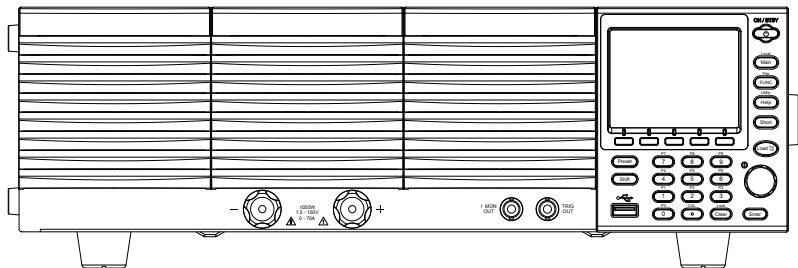

PEL-3111AH

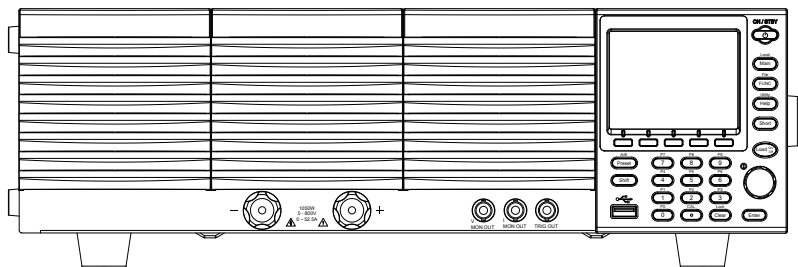

PEL-3211A/AH Booster Pack

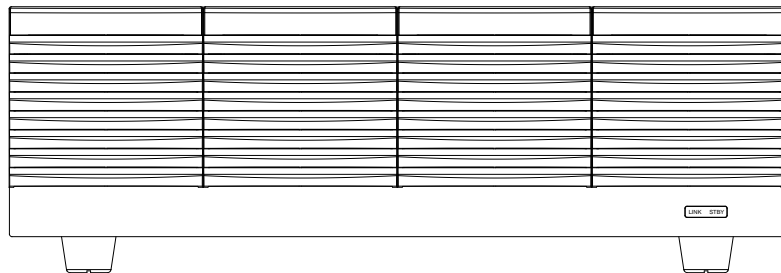

**Air Inlet**                      The air inlet has a removable dust filter

**LCD display**                 3.5 inch LCD display

**Function keys**              

The function keys directly correspond to the soft menu keys at the bottom of the display.

ON/STBY      ON / STBY  



Turns the unit on or puts the unit into standby mode. Use the power switch on the rear panel to turn the unit off.

Main/Local      Main



Main: Sets the operating mode: CC, CV, CR, CP mode.

Local (Shift + Main): Puts the instrument back into local mode from remote mode.

Local  
 Shift + 

FUNC/File      FUNC



FUNC: Sets the program function, sequence function or other special functions.

File (Shift + FUNC):  
 Shift +  Accesses the file system.

Help/Utility      Help



Help: Access the help menu.

Utility (Shift + Help):  
 Shift +  Access the utility menu.

Short      Short



Pressing the Short key will simulate shorting the input terminals.

The Short key will be lit when active.

Load on/off      Load <sup>On/</sup>Off



Turns the load on or off.

The Load On/Off key will be lit when active.

Scroll wheel      ①

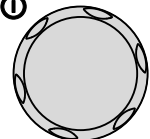

Use the scroll wheel to navigate the menu system or to edit parameters. See page 47 for usage details.

Enter  Press the Enter key to select highlighted menu items.

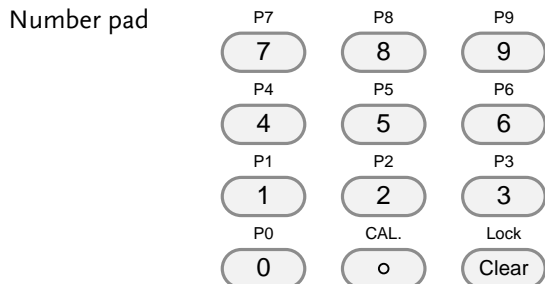



Number pad: Used to enter numerical values.

P0-P9 (Preset + Number keys): Loads one of 10 preset settings.

Clear/Lock  Clear: Clears the current parameter values.  
 Lock (Shift + Clear): Locks the front panel keys and selector knob.

Shift  Shift: Used in conjunction with other keys to select secondary functions.

Preset  Used in conjunction with the number pad to save or load preset settings P0 to P9.

USB Port   USB A port. Used for save and recall functions.

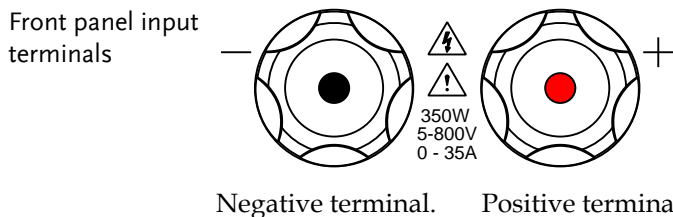

IMON Out



I MON OUT

Current monitor BNC terminal:  
Output connector used to monitor the current by outputting a voltage. An output voltage of 1V (10V for PEL-3000AH) corresponds to the full scale current for the H and L ranges. 0.1V (1V for PEL-3000AH) corresponds to the full scale current in the M range.

VMON Out



V MON OUT

Voltage monitor BNC terminal:  
Output connector used to monitor the voltage by outputting a voltage. An output voltage of 8V corresponds to the full scale voltage.

TRIG OUT



TRIG OUT

Trigger out BNC terminal:  
Outputs a pulse signal during sequence or dynamic operation. The trigger signal has a 5V output with a pulse width of a least 2.5 $\mu$ s and an impedance of 500 $\Omega$ .

LINK/STBY  
Indicator  
(PEL-3211A/AH)

**LINK STBY**

The LINK and STBY indicators indicate when the booster pack is properly connected and when the power has been turned on, respectively.

Rear Panel

PEL-3021A/ PEL-3041A

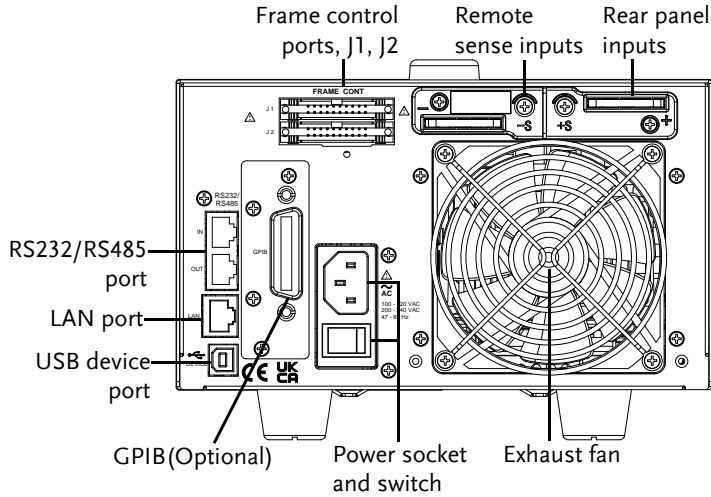

PEL-3021AH/ PEL-3041AH

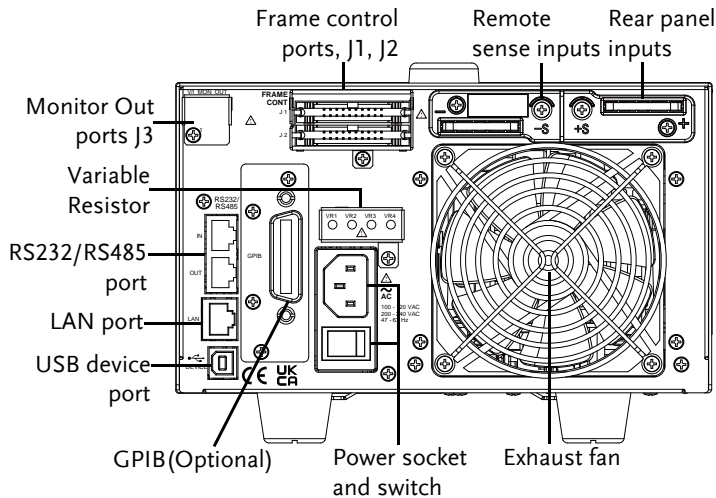

PEL-3111A

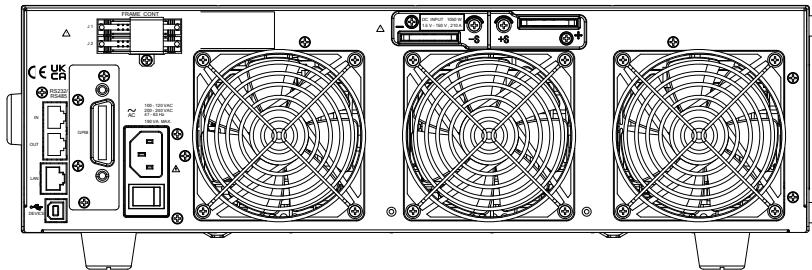

PEL-3111AH

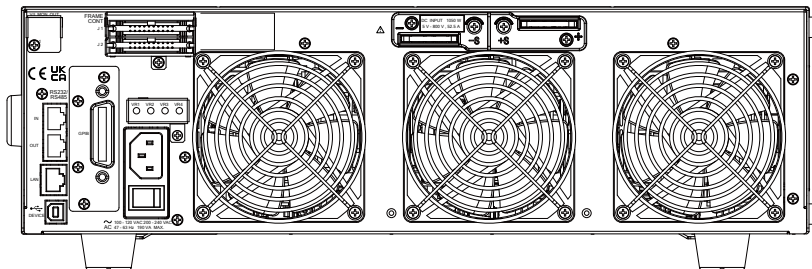

PEL-3211A Booster Pack

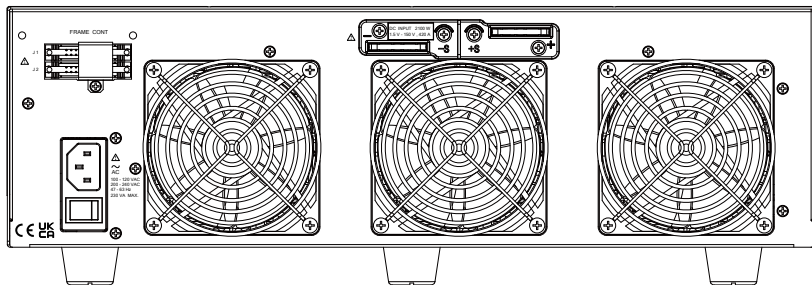



PEL-3211AH Booster Pack

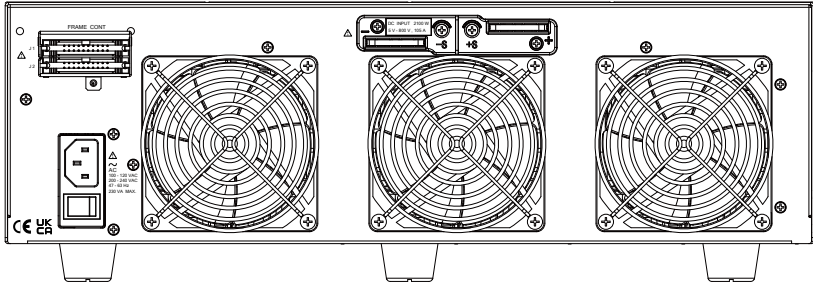

RS232/RS485 port

The USB B, RS232C and GPIB port are used for remote control.

GPIB port

USB B port

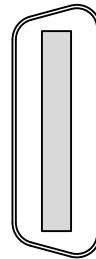
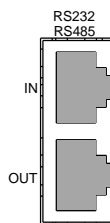
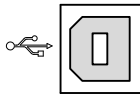

USB B port

RS232/RS485 RJ-45 port.

GPIB 24 pin female.

Frame control ports, J1, J2

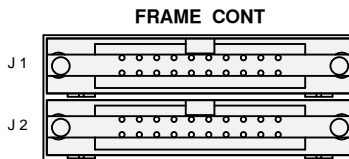

J1: The J1 connector is assigned to external control.

J2: The J2 connector is used for parallel operation control.

Monitor Out  
ports J3

EXT.CONT

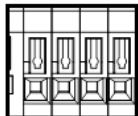

J3: The J3 connector is assigned to current and voltage monitor out.

Variable Resistor

VR1 VR2 VR3 VR4

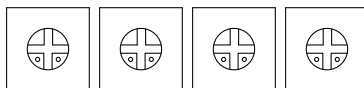

The variable resistors are used to adjust the full scale and offset setting for the input value of the external control sources such as voltage or resistance.

Exhaust fan

The exhaust fan is used to expel the heat from the unit. Please ensure there is at least 20cm distance between any object and the fan.

Rear Panel Input  
terminals

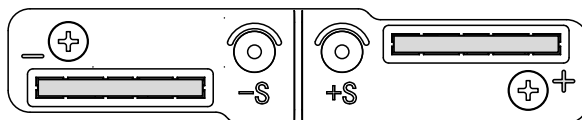

Rear Panel Input Terminals. Electrically connected to the front panel input terminals. Accepts M8 bolts or M4/M3 sized screws. See page 38 for connection details.

Remote Sensing  
Terminals

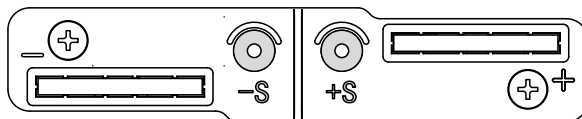

Sensing terminals for remote sense. See page 39. Accepts M3 sized screws.

Power Socket

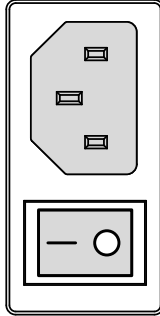

Power Socket:  
100-120V, 200-240V  
47-63Hz.

Power Switch

Turns the unit on/off.

LAN port



Ethernet port for controlling the  
PEL-3000A/AH remotely.

## Display

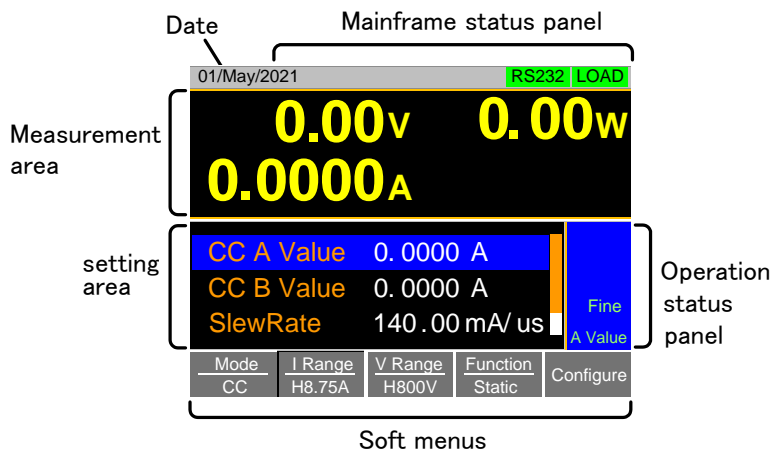

Setting area	The setting area is used to display and edit the settings for the current mode/function.
Measurement area	Displays the voltage, current and power values.
Date	Displays the date.
Mainframe status panel	The mainframe status panel displays the status of the load, remote control and short function.  When an icon is green it indicates that the function is off. When the icon is orange, the function is on.
Operation Status Panel	This status panel is used to display the status of the current mode.
Soft-keys	The soft-key menus are used to select different functions or parameters.

## First Time Use Instructions

Use the procedures below when first using the PEL-3000A/AH to install the rack mount kit, power up the instrument, set the internal clock, restore the factory default settings and check the firmware version. Lastly, the Conventions section will introduce you to the basic operating conventions used throughout the user manual.

### Rack Mount Kits

---

#### Description

The PEL-3000A/AH has a number of rack mount options for installation. The GRA-413 rack mounts are suitable for the PEL-3211A/AH booster pack. The GRA-414 rack mounts are capable of holding 1x PEL-3111A/AH or 2x PEL-3021A/AH or 3041A/AH units.

For installation details, please see the GRA-413 and GRA-414 Rack Mount Assembly Manual.

Please see your distributor for which rack mount is suitable for your application.

GRA-413-E  
(EIA standard)

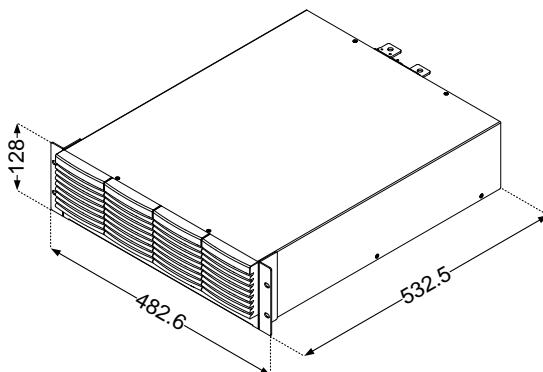
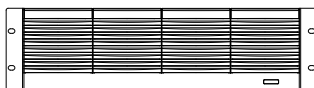

GRA-413-J  
(JIS standard)

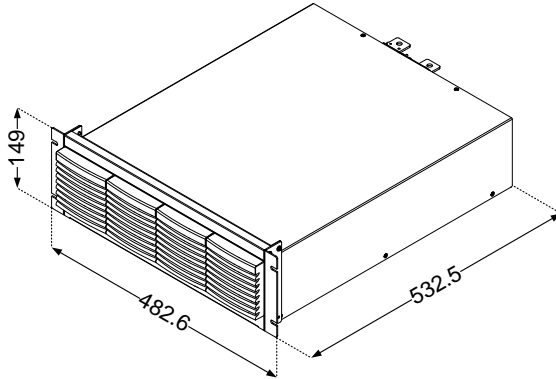
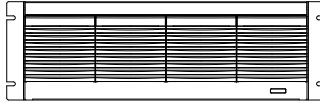

GRA-414-E  
(EIA standard)

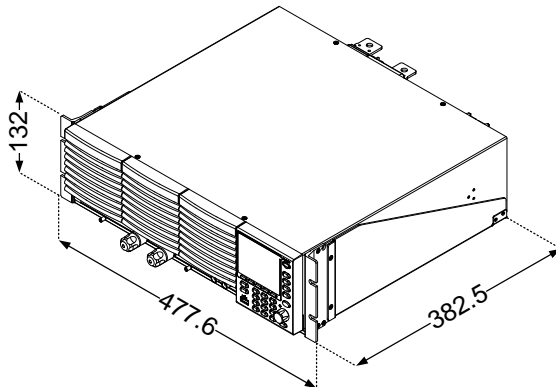
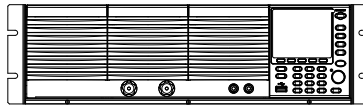

GRA-414-J  
(JIS standard)

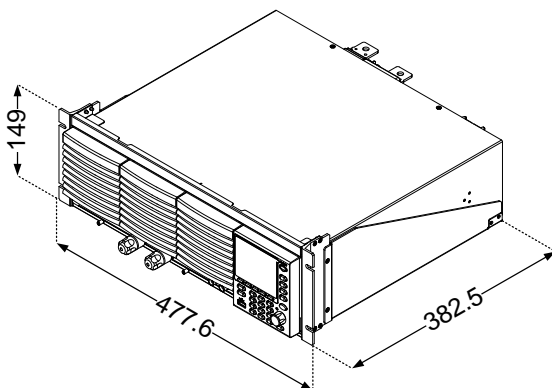
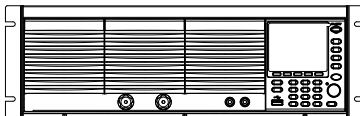

## Power Up and Self Test

Steps

1. Insert the AC power cord into the power socket.
2. Turn the external power switch on.  
(O → -)

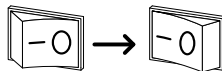

3. If the unit doesn't turn on, press the On/Standby key.
  - The ON/STBY key will go from standby (red) to on (green).

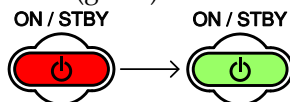

4. The unit will show the splash screen and then load the settings from when the unit was last powered down.



Note

If the PEL-3000A/AH fails to start up properly or does not turn on, please see your local distributor.



Note

If multiple units need to be started at the same time, the interval between turning on or off the power must be more than 15 seconds.

Do not turn the power on and off quickly.

## Load Default Settings

Description

When first using the PEL-3000A/AH, recall the factory default settings to ensure the unit is in a known state. See page 252 for a list of the default settings.



## Operation

1. Press  +  .
2. Select Media/Default[F1].
3. Select Factory Default[F2].



## Setting the Date and Time



---

**Description** The date and time settings are used to time-stamp files when saving files.

- The date is shown on top of the display.

---

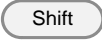
**Operation**

1. Press  +  > *Time Set*[F4] to set the date and time.

---

**Settings:** Month, Day, Year, Hour, Minute

---

01/May/2021 RS232 LOAD

Date

Date/Time

Month	10
Day	3
Year	2018
Hour	9
Minute	0

System Info	Load	Interface	Time Set	Other
-------------	------	-----------	----------	-------

## Load Wiring

### Wire Gauge considerations

Before connecting the unit to a power source, the wire gauge must be taken into account. Load wires must be large enough to resist overheating when a short-circuit condition occurs as well as to maintain a good regulation. The size, polarity and length of a wire are all factors in determining if a wire will withstand short circuiting.

Wires that are selected must be large enough to withstand a short circuit and limit voltage drops to no more than 2V per wire. Use the table below to help make a suitable selection.

AWG Gauge	Conduct or Diameter mm	Ohms per km	Max amps for chassis wiring
0000	11.684	0.16072	380
000	10.4038	0.2027	328
00	9.26592	0.25551	283
0	8.25246	0.32242	245
1	7.34822	0.40639	211
2	6.54304	0.51266	181
3	5.82676	0.64616	158
4	5.18922	0.81508	135
5	4.62026	1.02762	118
6	4.1148	1.29593	101
7	3.66522	1.6341	89
8	3.2639	2.0605	73
9	2.90576	2.59809	64
10	2.58826	3.27639	55
11	2.30378	4.1328	47
12	2.05232	5.20864	41
13	1.8288	6.56984	35
14	1.62814	8.282	32
15	1.45034	10.44352	28
16	1.29032	13.17248	22
17	1.15062	17.60992	19

18	1.02362	20.9428	16
19	0.91186	26.40728	14
20	0.8126	33.292	11
21	0.7239	41.984	9

**Load Line Inductance Considerations**

When using the PEL-3000A/AH load generator, voltage drop and voltage generated due to load line inductance and current change must be taken into account. Extreme changes in voltage may exceed the minimum or maximum voltage limits. Exceeding the maximum voltage limit may damage the PEL-3000A/AH.

To determine the voltage generated, the following equation can be used.

$$E = L \times (\Delta I / \Delta T)$$

E= voltage generated  
 L=load line inductance  
 $\Delta I$ = change of current (A)  
 $\Delta T$ = time ( $\mu$ s)

Load line inductance (L) can be approximated as 1uH per 1 meter of wire. ( $\Delta I / \Delta T$ ) is the slew rate in A/ $\mu$ s.

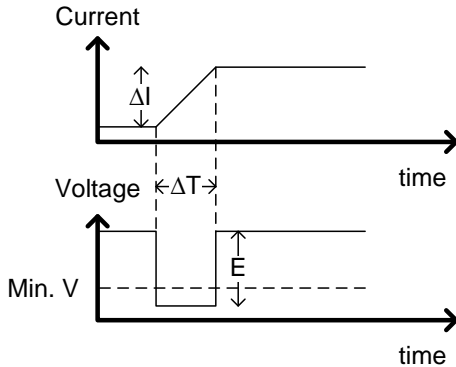

The diagram above shows how changes in current can affect voltage.

**Limiting Load line inductance**

- Load line inductance can be reduced in two ways.
2. Ensure load wires are as short as possible and

twist the positive and negative load wires together.

3. Current change can be limited by limiting the slew rate or response speed when switching in CR and CC mode.

“Twisted pair” will be shown on any connection diagram where the load wires should be twisted together.

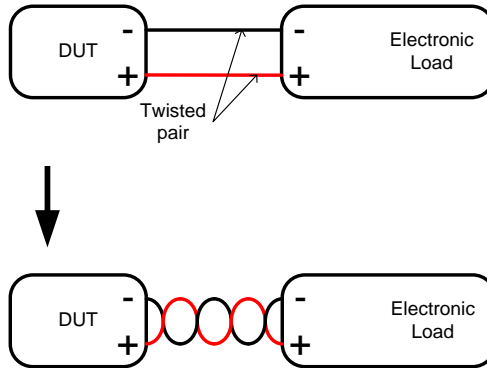

## Load Wire Connections

---

**Description** The PEL-3000A/AH has input terminals on both the front and rear panels.

Follow the procedures below for all load connections. Please adhere to the following precautions to ensure your safety and to protect the unit from damage.

---

- Connection**
1. When connecting the PEL-3000A/AH to the DUT, make sure that the polarity of the connection between the DUT and the unit matches.
  2. Ensure that the maximum input voltage is not exceeded. The maximum input voltage is 150(800) volts.

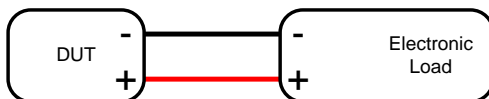

### Caution

If the polarity to the input terminals is reversed, the reverse voltage protection function is tripped. The reverse voltage protection function is tripped when reverse voltages greater than -0.3V are detected.

Do not touch any of the input terminals when the voltage is applied to an input terminal.

Connecting the input terminals to the wrong polarity can damage the DUT or the PEL-3000A/AH.

The front panel and rear panel input terminals are physically connected. Any voltage that is input to one set of terminals will also appear on the other set of terminals.

---

## Using the Front Panel Input Terminals

**Description** The front panel input terminals feature polarity-distinct caps and accept M6 sized crimped terminals.



**Caution**

The front panel input terminals on the PEL-3000A/AH are physically connected to the rear panel terminals.

### Steps

1. Turn the power off from the rear panel or put the unit into standby mode.
2. Turn the power off from the DUT.
3. Connect the load wires to the input terminals:
  - Connect the positive (+) input terminal on the load generator to the high potential output of the DUT.
  - Connect the negative (-) input terminal to the low potential output of the DUT.

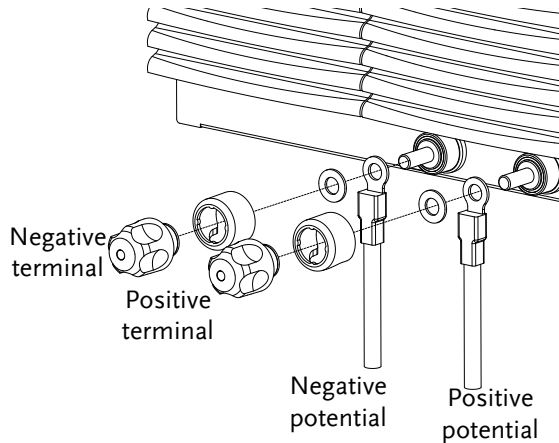

## Using the Rear Panel Input Terminals

**Description** The rear panel input terminals accept up to M8-sized crimped terminals. The rear terminals come with a load input terminal cover for safety.



**Caution**

The front panel input terminals on the PEL-3000A/AH are physically connected to the rear panel terminals.

**Steps**

1. Turn the power off from the rear panel or put the unit into standby mode.
2. Turn the power off from the DUT.
3. Connect the load wires to the input terminals:
  - Connect the positive (+) input terminal on the load generator to the high potential output of the DUT.
  - Connect the negative (-) input terminal to the low potential output of the DUT.

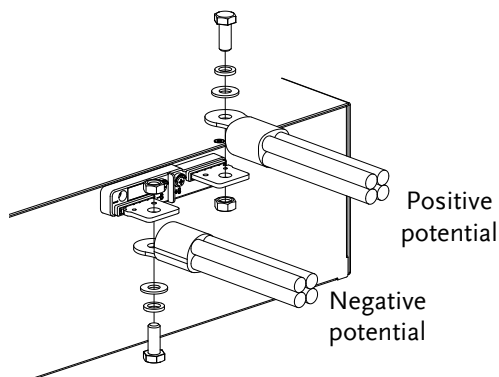



## Using the Terminal Cover (PEL-011)

---

**Description** The rear panel terminal cover should be used to prevent electric shock. The rear panel terminal covers should always be used when connecting a load to the rear panel terminals. As the front panel and rear panel terminals are physically connected, the terminal cover should also be used as a safety measure when a DUT is connected to the front terminals

---



**Caution**

Ensure the power is off before making any connections to the PEL-3000A/AH.

---



**Note**

In the following diagrams, the cable wiring is not shown for clarity.

---

1. Remove the screw holding the top cover to the bottom cover.

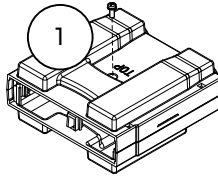

2. Line-up the bottom cover with the notches in the output terminals.
3. Place the top terminal cover over the bottom cover.

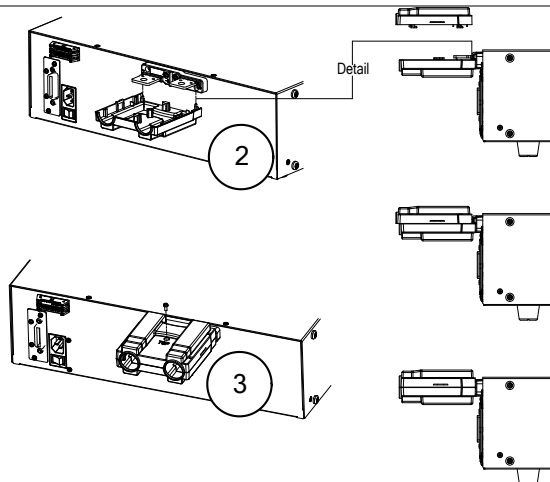

- 4. Use your thumb to slide the terminal covers shut, as shown in the diagram below.

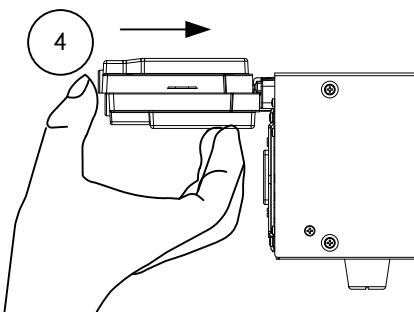

- 5. When the top and bottom covers are flush, reinsert the screw that was removed in step 1.

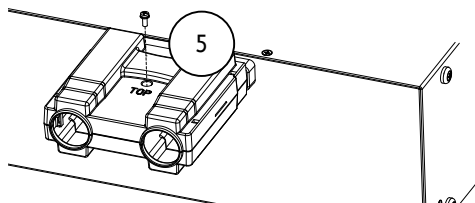

## Using the Terminal Cover (PEL-013)

**Description** The flexible rear panel terminal cover should be used when the load wiring becomes too thick to be used with the PEL-011 terminal cover. This is especially true when using the load generators in parallel. Like the PEL-013 terminal cover, the PEL-011 is used to prevent electric shock. The rear panel terminal covers should always be used when connecting a load to the rear panel terminals.



**Caution**

Ensure the power is off before making any connections to the booster pack.

1. Wrap the insulation sheets around the terminals and load cables, as shown below. Make sure the terminals and any exposed wires are covered by the sheets.

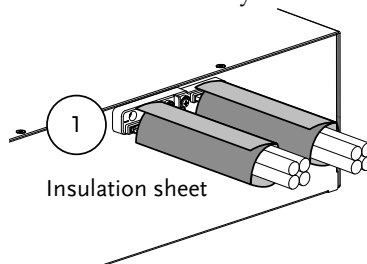

2. Secure the insulation sheets using the supplied velcro fasteners. 2 fasteners should be used for each sheet.

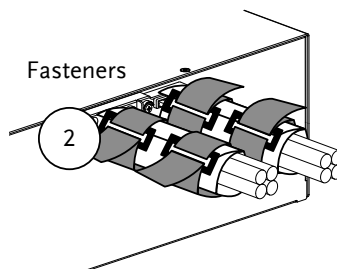

## Using the Terminal Cover

**Description** After connection is finished, please lock terminal cover to avoid electric shock when using the frame control terminal for PEL-3000AH series.

If connection is needed, please unlock terminal cover, If connection isn't needed, please lock terminal cover to avoid electric shock for PEL-3000AH series.



**Caution**

Ensure the power is off before making any connections to the booster pack.

Install the terminal cover as shown in the picture below (for PEL-3000AH series).

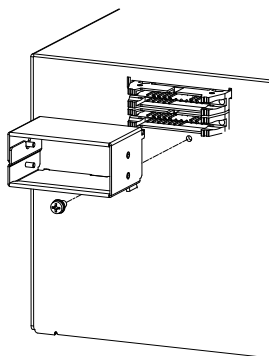

Install the terminal cover as shown in the picture below (for PEL-3000A series).

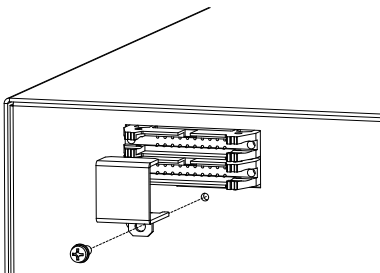

## Using the Monitor Out Cover (Only for PEL-3021AH, PEL-3041AH, PEL-3111AH)

---

**Description** After connection is finished, please lock monitor out cover to avoid electric shock when using the monitor out ports.

---

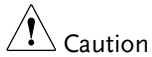

Ensure the power is off before making any connections to the booster pack.

---

Install the monitor out cover as shown in the picture below.

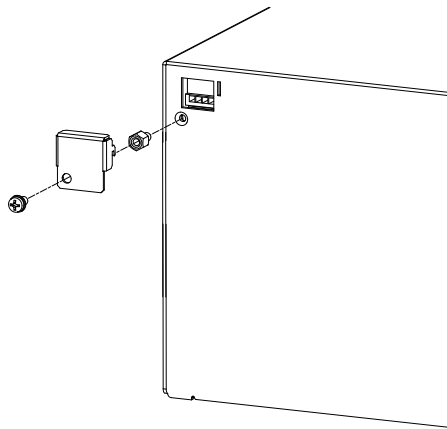

## Remote Sense

### Description

Remote sense can be used to help compensate for long cable length. The longer the cable, the higher the potential resistance and inductance, therefore a short cable is best. Twisting the cable can help reduce induced inductance and using the Vsense terminals compensates the voltage drop seen across the load leads, especially leads with higher resistance. This is useful when used in CV, CR or CP mode.

### Steps

1. Turn the power off from the rear panel or put the unit into standby mode.
2. Turn the power off from the DUT.
3. Connect the sense wires to the sense terminals:
  - Connect the positive sense (+S) terminal to the high potential output of the DUT.
  - Connect the negative sense (-S) terminal to the low potential output of the DUT.

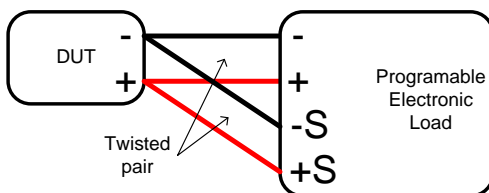



## Firmware Update

**Description** The PEL-3000A/AH allows the firmware to be updated by end-users. Before using the PEL-3000A/AH, please check the GW Instek website or ask your local distributor for the latest firmware.



**System version** Before updating the firmware, please check the firmware version.

**Operation**

1. Press  +  .
2. Select System/Info[F1].
3. The System information is listed on the display.
  - Model: PEL-3000A/AH model number.
  - Serial Number: XXXXXXXX
  - Firmware Ver.: Firmware version number.
  - Website address.
4. To view other system information, press *System*[F1] and select *Memo*.

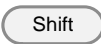

- Update Firmware
1. Insert a USB drive into the USB port. Ensure the USB drive has the firmware file located in the root directory.

2. Press  +  .
3. Select USB with the *Media[F1]* soft-key.
4. Press the *File Utility[F5]* soft-key.
5. Select the \*.UPG upgrade file and press *Select[F1]* twice. Once to select the file and once to confirm.
6. Wait for the update to complete and reset the power when prompted.



Note

Do not turn the load generator off or remove the USB memory when the firmware is being read or upgraded.



## Conventions

The following conventions are used throughout the user manual. Read the conventions below for a basic grasp of how to operate the PEL-3000A/AH menu system using the front panel keys.

**Soft Menu keys** The F1 to F5 function keys at the bottom of the display correspond directly to the soft-menu keys on top.

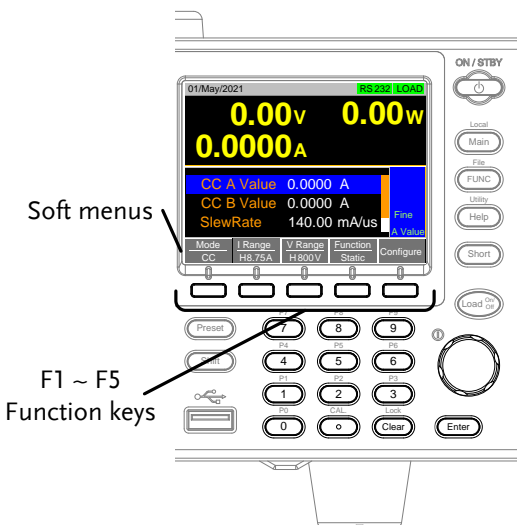

### Select Sub Menu

Configure

Pressing this type of soft-menu key will enter a submenu.

Toggle Parameter or State

Function/Item



Parameter or State

This type of soft-menu icon has the function/item on the top of the label and the selected setting or mode on the bottom of the label.

Repeatedly press the associated function key (F1-F5) to cycle through each setting. For example, repeatedly pressing the *Mode* soft-menu key will cycle through the CC, CR, CV and CP modes.

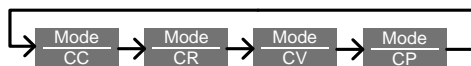

For some parameters, a popup window will also appear. Selection of the setting is the same. Repeatedly pressing the relevant function key (F1-F5) will cycle through each setting. The selection on the popup window will also be reflected on the label.

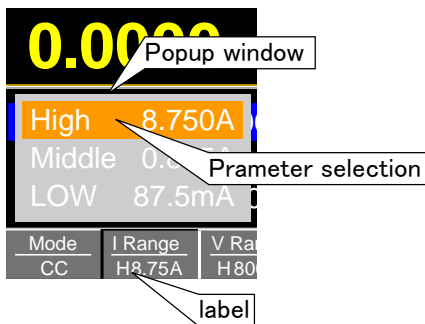

Parameter Input

The scroll wheel, Enter key and number pad can be used to edit parameter values.

**Number pad**

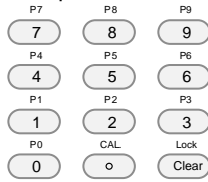

**Scroll wheel**



Enter key

1. Use the scroll wheel to move the cursor to the desired parameter.
- A scroll bar is shown when there are additional parameters off-screen.

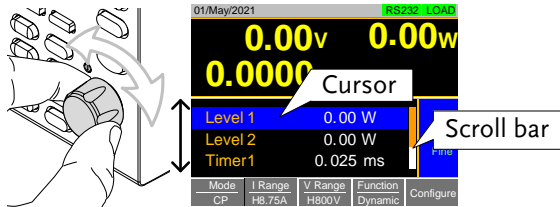

2. Press the Enter key to select the parameter. The parameter will become highlighted in white

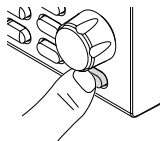

3. Then use the number pad\* or scroll wheel\*\* to edit the parameter value.

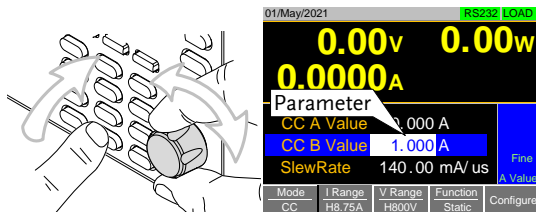

4. Press the Enter key again to finish editing the parameter value.

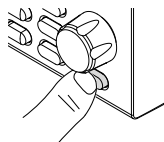

**Clearing a Value\*** \*When editing a parameter with the number pad, pressing the **Clear** key will restore the parameter to the previous value.

**Using the Scroll Wheel to Edit a Parameter\*\*** \*\*To edit a parameter using the scroll wheel, simply turn the scroll wheel. Clockwise increases the value, counterclockwise decrease the value.

Pressing the scroll wheel when a parameter is highlighted allows you to change the step resolution. There are two different step resolution methods: Step Mode and Cursor Mode. Step Mode: This is the default step resolution method and will only be available to use when it is applicable (Indicated by *Fine* or *Coarse* in the Operation Status panel).

When a parameter is highlighted (step 3 above) pressing the scroll wheel will toggle the step resolution between fine and coarse. For details on how to set the step resolution, see page 83.

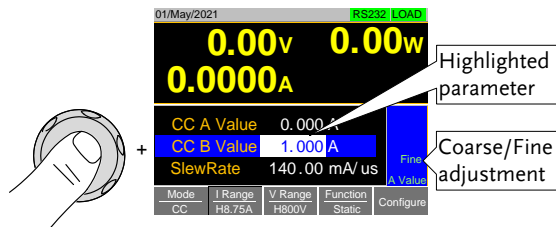

**Cursor Mode:** This method must first be enabled before it can be used. Pressing the scroll wheel when a parameter is highlighted allows you to set the step resolution by a digit value. An orange line will appear under the currently selected digit value. Repeatedly pressing the scroll wheel moves to the next digit. See page 82 for details.

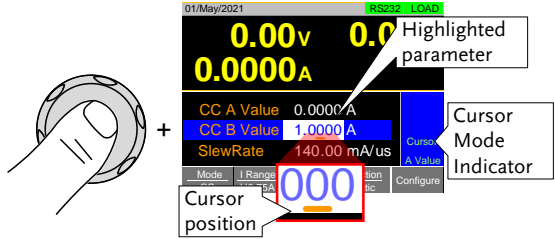

**Entering Alphanumeric Characters**

When renaming files, creating memos or notes, you will be required to enter alphanumeric characters when the character entry screen appears.

- Only alphanumeric characters as well as space [ ], underscore [ \_ ] and minus [ - ] characters allowed.

1. Use the scroll wheel to move the cursor to the desired character.

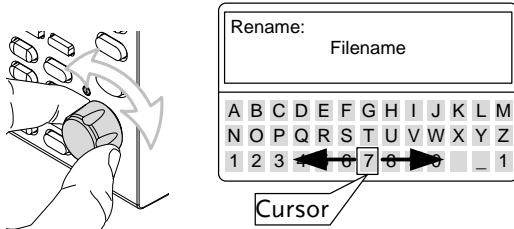

2. Press the **Enter** key or *Enter Character*[F1] to select a character.

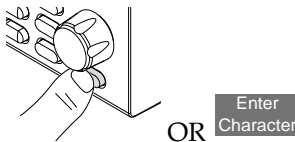

3. To delete a character, press *Back Space*[F2].
4. To save the file name or memo, press *Save*[F3].

## Help Menu

When any function key has been pressed or when a menu has been opened, the HELP key can be used to display a detailed description.

### Help Selection

1. Press any function key or soft-menu key.
2. Press  to see the help contents on that particular function key or menu.
3. Use the scroll to navigate the help contents.
4. Press the *Exit[F5]* key to exit the help menu.

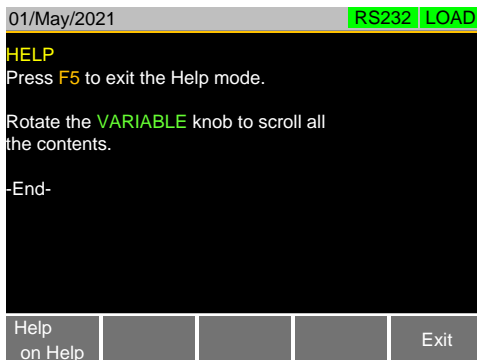

# O PERATION

<b>Basic Operation</b> .....	<b>56</b>
CC Mode .....	56
CR Mode .....	58
CR Units .....	59
CV Mode .....	60
CP Mode .....	61
+CV Mode .....	63
Turning on the Load .....	64
Shorting the Load .....	64
Safety Short .....	65
Short Key Configuration .....	66
Short Function Enable/Disable .....	67
Locking the Front Panel Controls .....	67
<b>Basic Configuration</b> .....	<b>68</b>
Select the Switching Function .....	68
Select the Display Units for Dynamic Mode Levels .....	70
Select the Switching Time Configuration for Dynamic Mode .....	71
Slew Rate .....	72
CV, +CV Mode Response Speed .....	73
CC, CR and CP Mode Response Speed .....	74
<b>Advanced Configuration Settings</b> .....	<b>75</b>
Soft Start .....	75
Von Voltage Settings .....	76
Von Voltage .....	76
Von Latch .....	77
Von Delay .....	78
Timer Functions .....	78
Count Time .....	78
Cut Off Time .....	79
Auto Load Configuration .....	80
Load Off (Mode) and Load Off (Range) .....	81
<b>Step Resolution Configuration</b> .....	<b>82</b>
Cursor Mode Configuration .....	82

Step Mode Configuration .....	83
<b>Protection Settings .....</b>	<b>85</b>
OCP .....	85
OPP .....	86
UVP .....	87
UVP Ring Time .....	88
OVP .....	90
UnReg .....	91
Para .....	92
RVP .....	93
<b>System Settings .....</b>	<b>94</b>
Sound Settings .....	94
Speaker Settings .....	94
Alarm Tone Settings .....	95
Display Settings .....	95
Panel .....	95
Contrast and Brightness .....	95
Control Settings .....	96
Language Settings .....	96
Input/ Output Trigger Settings .....	97
Trigger In Delay .....	97
Trigger Out Width .....	97
Measure Average .....	97
Measure Period .....	98
RVP Load Off .....	98
<b>Go-NoGo .....</b>	<b>100</b>
Setting the Go-NoGo Limits .....	100
Running a Go-NoGo Test .....	101
<b>Save Recall .....</b>	<b>103</b>
File Structure .....	103
File Types .....	104
Saving Files to Internal Memory .....	105
Saving Files to USB Memory .....	107
Recalling Files from Internal Memory .....	109
Recalling Files from USB Memory .....	110
Recall Memory Safety Setting .....	112
File Utility .....	112
Preset .....	114
Quick Preset Save .....	114
Quick Preset Recall .....	114
Default Settings .....	115
Factory Default Settings .....	115
User's Default Setting .....	115



<b>FUNCTION MENU</b> .....	<b>116</b>
Function Menu Overview .....	117
Select a Function.....	117
Turning on the Load with the Selected Function .....	119
Complete Ring Time .....	120
NSEQ Timer .....	121
<b>Program</b> .....	<b>123</b>
Program Overview.....	123
Create a Program .....	125
Create a Program Chain.....	128
Running a Program or Chain.....	129
<b>Sequence</b> .....	<b>131</b>
Normal Sequence Overview .....	131
Timing Edit Configuration .....	135
Data Edit Configuration .....	137
Running a Normal Sequence .....	138
Fast Sequence Overview.....	141
Timing Edit Configuration .....	145
Data Edit Configuration .....	146
Running a Fast Sequence.....	148
<b>OCP Test Automation</b> .....	<b>150</b>
<b>OPP Test Automation</b> .....	<b>157</b>
<b>BATT Test Automation</b> .....	<b>164</b>
<b>MPPT</b> .....	<b>172</b>
Edit Tracking of MPPT function.....	176
Auto Load of MPPT function.....	177
Data file of test result.....	182

## Basic Operation

The PEL-3000A/AH supports 7 main operating modes:

CC, CC+CV;

CR, CR+CV;

CV;

CP, CP+CV

### CC Mode

Description	In Constant Current Mode the load units will sink the amount of current programmed. Regardless of the voltage, the current will stay the same. For more details on CC mode, please see the Appendix on page 261.
-------------	--



Warning

If you change the mode or the range when the load is already on, the load will be turned off automatically.

Operation

1. Make sure the load is off.
2. Press  .
3. Select CC mode with the *Mode[F1]* soft-key.
4. Select the current range with the *I Range[F2]* soft-key.

Range:	High, Middle, Low
--------	-------------------

5. Select the voltage range with the *V Range[F3]* soft-key.

Range:	High, Low
--------	-----------

6. Set the current level parameters using the scroll wheel and number pad.
  - For Static mode, set *CC A Value* and/or *CC B Value*.
  - For Dynamic mode, set *Level1* and *Level2*.
  - The maximum and minimum current levels depend on the selected ranges.
7. To add CV mode to CC mode (CC+CV), see page 63.
8. Set the remaining basic configuration settings such as the slew rate, and switching function settings. See page 68 for details.

---

### Display

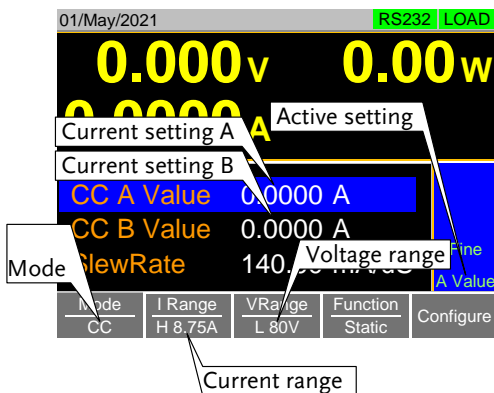

Note

Basic CC mode configuration is complete. See page 68 for more configuration options.

The current range and voltage range applies to all the operating modes.

## CR Mode

---

**Description** In Constant Resistance Mode, the unit will maintain a constant resistive load by varying the current. CR mode uses ohms,  $\Omega$  (resistance) or siemens, S (conductance) for the setting units. For more details on CR mode, see the appendix on page 262.



### Warning

If you change the mode or the range when the load is already on, the load will be turned off automatically.

### Operation

1. Make sure the load is off.
2. Press  .
3. Select CR mode with the *Mode[F1]* soft-key.
4. Select the current range with the *I Range[F2]* soft-key.
 

---

Range: High, Middle, Low

---
5. Select the voltage range with the *V Range[F3]* soft-key.
 

---

Range: High, Low

---
6. Set the resistance or conductance level parameters using the scroll wheel and number pad.
  - For Static mode, set *CR A Value* and/or *CR B Value*.
  - For Dynamic mode, set *Level1* and *Level2*.
  - The maximum and minimum conductance/resistance levels depend on the selected current range.
7. To add CV mode to CR mode (CR+CV), see page 63.
8. Set the remaining basic configuration settings

such as the slew rate, and switching function settings. See page 68 for details.

Display

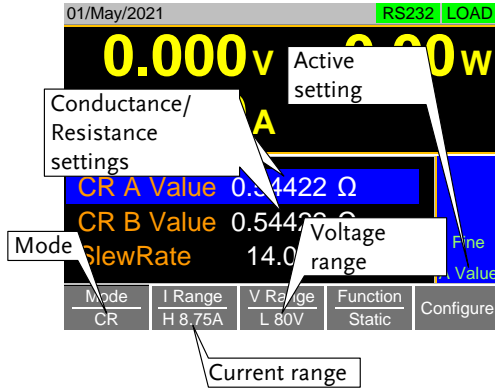

Note

Basic CR mode configuration is complete. See page 68 for more configuration options.

The current range and voltage range applies to all the operating modes.

CR Units

Description

The CR setting units can be set to ohm ( $\Omega$ ) or millisiemens (mS).

Operation

1. Make sure the load is off.
2. Press **Main** > *Configure*[F5] > *Other*[F2] and set the *CR Unit* setting.

Range:  $\Omega$ , mS

## CV Mode

---

**Description** In Constant Voltage Mode, the unit will maintain a constant voltage. In CV mode you set the constant voltage level. For more details on CV mode, see the appendix on page 265.

---



### Warning

If you change the mode or the range when the load is already on, the load will be turned off automatically.

---

### Operation

1. Make sure the load is off.
  2. Press  .
  3. Select CV mode with the *Mode[F1]* soft-key.
  4. Select the current range with the *I Range[F2]* soft-key.
- 

Range: High, Middle, Low

---

5. Select the voltage range with the *V Range[F3]* soft-key.
- 

Range: High, Low

---

6. Set the voltage level parameters using the scroll wheel and number pad.
    - Set CV A Value and/or CV B Value.
    - The maximum and minimum voltage levels depend on the selected voltage range.
  7. Set the remaining basic configuration settings such as the response settings. See page 68 for details.
-

Display

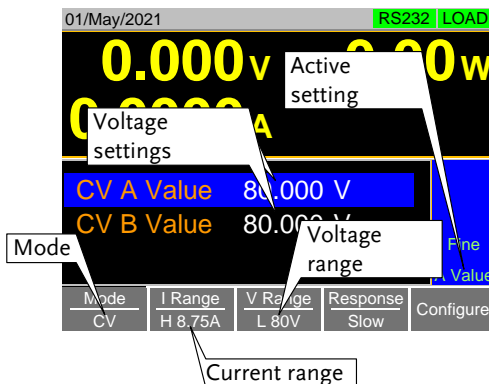

Note

Basic CV mode configuration is complete. See page 68 for more configuration options.

The current range and voltage range applies to all the operating modes.

CP Mode

Description

In Constant Power Mode, the unit will maintain a constant power by varying the current. For more details on CP mode, see the appendix on page 264.



Warning

If you change the mode or the range when the load is already on, the load will be turned off automatically.

Operation

1. Make sure the load is off.
2. Press .
3. Select CP mode with the *Mode*[F1] soft-key.
4. Select the current range with the *I Range*[F2] soft-key.

Range: High, Middle, Low

5. Select the voltage range with the *V Range*[F3] soft-key.

Range: High, Low

6. Set the power level parameters using the scroll wheel and number pad.
  - For Static mode, set *CP A Value* and/or *CP B Value*.
  - For Dynamic mode, set *Level1* and *Level2*.
  - The maximum and minimum power levels depend on the selected current range.
  - For static mode, the parameter that is set last becomes the “active” setting. This will be shown in the Operation Status Panel.
7. To add CV mode to CP mode (CP+CV), see page 63.
8. Set the remaining basic configuration settings such as the slew rate, and timer settings. See page 68 for details.

Display

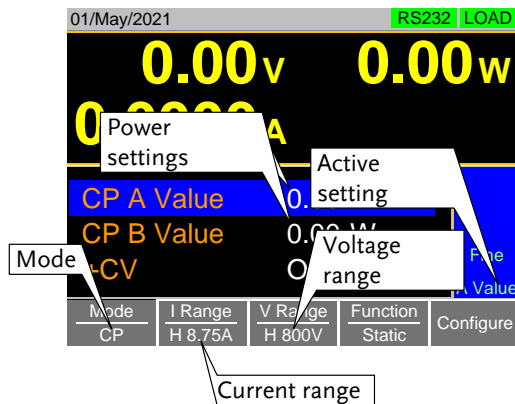

 Note

Basic CP mode configuration is complete. See page 68 for more configuration options.

The current range and voltage range applies to all the operating modes.



## +CV Mode

Description +CV mode can be added to CC, CR and CP mode.

- The +CV settings apply to all applicable modes.

Operation

- Make sure the load is off.
- Press **Main** and select to Mode, I Range and V Range.
- Set the +CV voltage level. (You may need to scroll down to the +CV setting)

Range: OFF - rated voltage+5%

Display

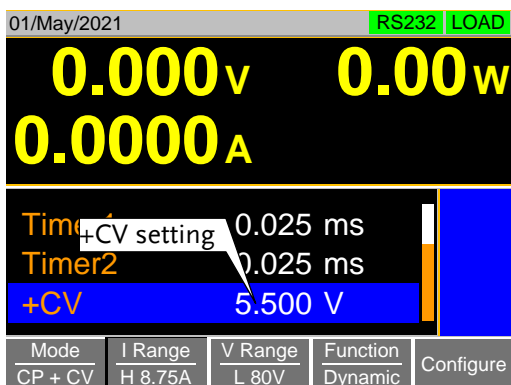

Note

The +CV settings apply to all the applicable operating modes.

For example: The +CV settings made in CR mode will be carried over to the +CV settings in CC and CP mode.





Note

+CV settings can be controlled with external control. (Only for PEL-3000AH series)

See page 188 for +CV settings with external control

## Turning on the Load

---

- Description
- The load can be turned on and off by pressing the  key.
    - The  key will turn orange when the load is “on”.
    - The LOAD icon in the Main Frame status panel will turn orange when the load is on.



Note

- The load can be set to automatically turn on at start up. See page 80.
- The load can be turned on via remote control. See the programming manual.
- The load can be turned on via external control. See page 198.
- By default the load will automatically turn off if the range or operating mode (CC, CV, CR, CP) is changed. To disable this behavior, Set *Load Off (Mode)* and *Load Off (Range)* to the *OFF* setting. See page 81 for details.

Display



## Shorting the Load



---

- Description
- The Short key can be used to simulate a short circuit of the load input terminals. A short circuit is simulated by:
- Setting the current to the maximum value in CC mode.
  - Setting the resistance to the minimum value in

CR mode.

- Setting the voltage to the minimum value in CV mode.
- Setting the power to the maximum value in CP mode.
- When the load is shorted, the external controller also sends a short signal. See page 204 for usage details.

Operation

1. The short function can be turned on and off by pressing the  key.
- The  key will turn red when the short function is active.
- The Short icon will appear when the short function is active.

Display

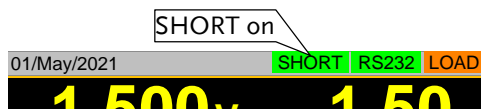

Note

If the load is already off, pressing the Short key will turn the load on (shorted) at the same time. Pressing the Short key again will also turn the short off again as well.

If the load is already on and the Short key is pressed, then when the Short key is pressed again the load will remain on (the electronic load will return to its previous load condition).



Note

The Short key will be disabled if the Short Function setting is turned off. See page 66 for details.

### Safety Short

Description

When activated, the safety short function only allows the short key to be used when the load is already on.



Operation	<ol style="list-style-type: none"> <li>Press  &gt; <i>Configure</i>[F5] &gt; <i>Other</i>[F2] and set the <i>Short Safety</i>. <ul style="list-style-type: none"> <li>When set to OFF, the load can be shorted at any time.</li> <li>When set to ON, the load can only be shorted when the load is already on.</li> </ul> </li> </ol>
	Short (Safety):            OFF, ON



Note

The Short Safety setting will be grayed out if Short Function is set to OFF. See page 66 for details.

### Short Key Configuration

Description	<p>The Short key can be configured to Toggle or Hold. By Default the Short key is set to Toggle.</p> <ul style="list-style-type: none"> <li>Toggle: Pressing the Short key will toggle the shorting function on or off.</li> <li>Hold: Holding the short key will short the load.</li> </ul>
Operation	<ol style="list-style-type: none"> <li>Press  &gt; <i>Configure</i>[F5] &gt; <i>Other</i>[F2] and set the <i>Short Key</i> setting.</li> </ol>
	Range:            Toggle, Hold
	Note
	The Short Key setting will be grayed out if Short Function is set to OFF. See page 66 for details.



## Short Function Enable/Disable

---

Description	The short key can be disabled to prevent the operator accidentally shorting the load.
Operation	<ol style="list-style-type: none"> <li>Press  &gt; <i>Configure</i>[F5] &gt; <i>Other</i>[F2] and set the <i>Short Function</i>.</li> <li>When set to OFF, the Short key is disabled and all short configuration options in the Main&gt;Configure&gt;Other menu are also disabled.</li> <li>When set to ON, the Short key is enabled.</li> </ol>
	Short Function:            OFF, ON

## Locking the Front Panel Controls

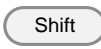
---

Description	The keys and scroll wheel on the front panel can be locked to prevent settings from being changed.
Operation	<ol style="list-style-type: none"> <li>The keys can be locked and unlocked by pressing  +  .</li> <li>LOCK will appear in the Mainframe status panel when the keys are locked.</li> <li>The  key will not be locked if the load is on.</li> </ol>
Display	LOCK will appear in the Mainframe status panel when the keys are locked.

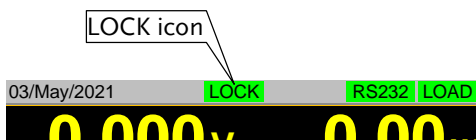

## Basic Configuration

The basic configuration settings are the common configuration settings that are used for each operating mode. After selecting a basic operating mode (CC, CR, CV or CP mode), the slew rate, switching function, response rate and other common parameters should be configured.

### Select the Switching Function

---

#### Description

The PEL-3000A/AH has two switching function, static and dynamic. The switching function allows the PEL-3000A/AH to switch between two preset levels. Static mode can only switch between the two levels manually, while Dynamic mode switches between each level automatically based on a timer.

- Static mode: A Value, B Value
- Dynamic mode: Level1, Level2

When the unit is set to static mode, only one value (A Value or B Value) can be active at a time. The active value is shown in the Operation Status Panel.

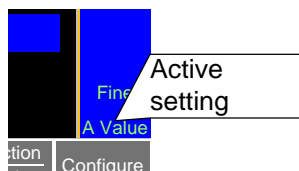

When the unit is set to dynamic mode, the unit will switch between Level1 and Level2 based on the Timer1 and Timer2 parameters, shown below.

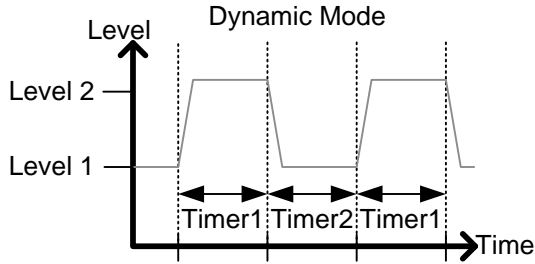

---



Note

Dynamic mode is not available for CV mode.

### Operation

1. Make sure the load is off.
2. Press  .
3. Select Dynamic or Static mode with the *Function*[F4] soft-key.
  - A different switching function can be set for CC, CR and CP mode.
4. For dynamic mode, set the Timer1 and Timer2 parameters using the scroll wheel and number pad.
  - Timer1 sets the Level1 on-time.
  - Timer2 sets the Level2 on-time.
  - Take the slew rate settings into consideration when setting the timers.
  - The frequency of the dynamic switching is output via the TRIG OUT BNC.
5. In the static mode, select either value A or value B as the "active" value for execution followed by pressing the  +  .
  - The "active" value will be shown in the Operation Status Panel.
  - The load can be "on" when switching between A Value and B Value.

Display:  
Static Mode

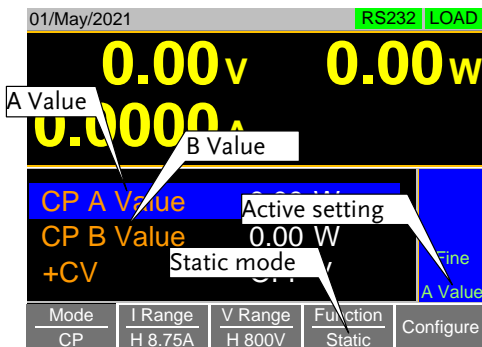

Display:  
Dynamic Mode

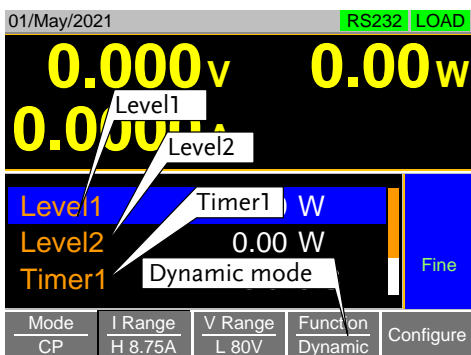

### Select the Display Units for Dynamic Mode Levels

**Description**

When Dynamic mode is selected, the Level1 and Level2 values can be set to either discrete values or as a percentage of a set value.

- The setting applies to all applicable operation modes.
- By default the units are set to Value.
- When Percent is chosen, 100% = 100% of the Set power, current or resistance value.



- Operation
1. Make sure the load is off.
  2. Press **Main** > *Configure*[F5] > *Other*[F2] and set the *Dyna. Level* setting.

Range: Value, Percent

Display:  
Percent Setting

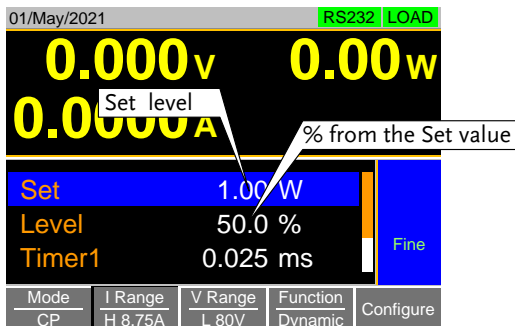

Example

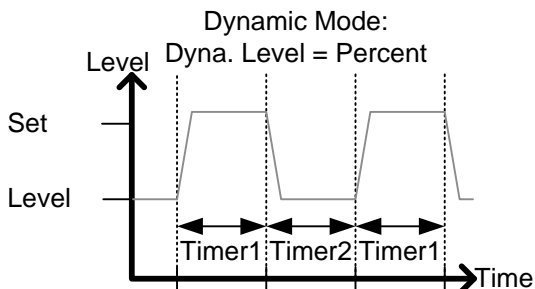

Select the Switching Time Configuration for Dynamic Mode

Description The switching time for dynamic mode can be configured to switch between two preset on-times (Timer1, Timer2) or by setting a switching frequency and duty cycle.

- Operation
1. Press **Main** > *Configure*[F5] > *Other*[F2] and set the *Dyna. Time* setting.

Range: T1/T2, Freq. Duty

## Slew Rate

**Description** The current slew rate can be set for CC and CR mode. The slew rate setting is used to limit the change in current when switching.

For static mode, only a single slew rate can be set.

- Operation**
1. Make sure the load is off.
  2. Press  .
  3. Set the slew rate(s) using the scroll wheel and number pad.
    - For static mode, only a single slew rate can be set.
    - For dynamic mode, set both the rising and falling slew rates.
    - Take the timer settings into consideration when setting the slew rates.

**Display**

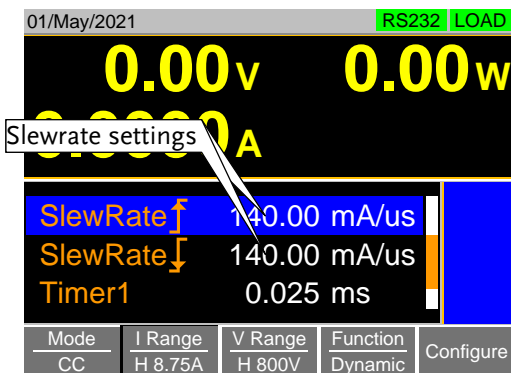

## CV, +CV Mode Response Speed

---

Description	<p>The response speed setting is the response speed for the negative feedback control of the load current when used in CV, +CV mode. Response speed settings are only applicable to CV, +CV mode.</p> <ul style="list-style-type: none"> <li>• A response speed that is too fast could cause the unit to be unstable.</li> <li>• Reducing the response speed can improve stability.</li> </ul>
Operation	<ol style="list-style-type: none"> <li>1. Make sure the load is off.</li> <li>2. Press . Make sure the unit is in CV mode by using the <i>Mode[F1]</i> soft-key.</li> <li>3. Select the response speed with the <i>Response[F4]</i> soft-key.</li> </ol>
Range:	<p>Slow, Fast (for PEL-3000) Fast, 6, 5, 4, 3, 2, 1, slow (for PEL-3000AH series)</p> <p>CV mode: The response speed settings Fast, 6, 5, 4 are all the same for CV mode.</p> <p>+CV mode: The response speed settings 5 and 4 are the same for CV mode. The response speed settings Slow and 1 is the same.</p>

Display

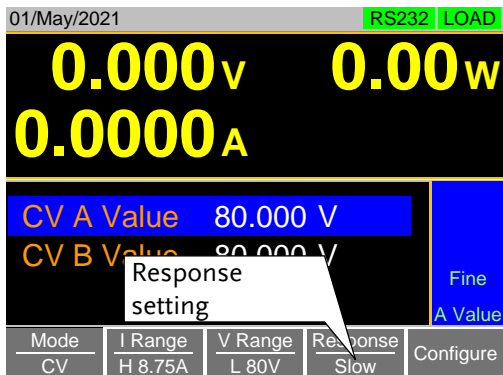

## CC, CR and CP Mode Response Speed

Description

By default, the “normal current response” speed is set to 1/1. The response speed can be reduced to 1/2, 1/5, 1/10.

- Reducing the current response speed can affect other settings such as the slew rate and soft start settings.

Operation

1. Make sure the load is off.
2. Press **Main** > *Configure*[F5] > *Other*[F2] and set the *Response* parameter.

Range:  $\frac{1}{1}$ ,  $\frac{1}{2}$ ,  $\frac{1}{5}$ ,  $\frac{1}{10}$

## Advanced Configuration Settings

Use the advanced configuration settings to configure settings other than those described in the basic configuration chapter.

### Soft Start

**Description** The soft start setting is used to limit the amount of input current at start-up or from when the Von Voltage threshold is tripped.

- The soft start setting only applies to CC, CR and CP mode (CP mode only for PEL-3000 series).

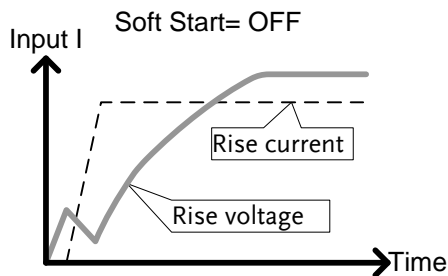
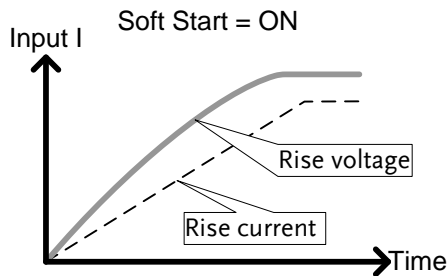

**Operation**

1. Press **Main** > *Configure*[F5] > *Other*[F2] and set the *Soft Start* time.

Range: OFF, 1-200ms for PEL-3000A series  
OFF, 3-200ms for PEL-3000AH series

## Von Voltage Settings

### Von Voltage

**Description**      The Von Voltage is the threshold voltage at which the load module will start to sink current.

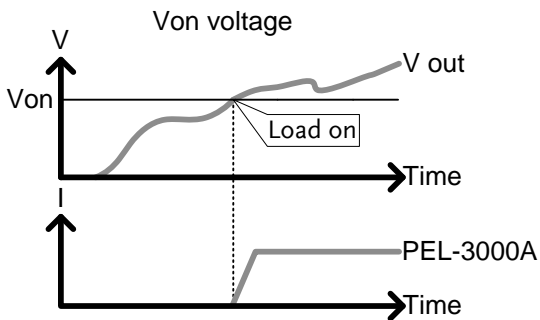

**Operation**

1. Press **Main** > *Configure*[F5] > *Other*[F2] and set the *Von Voltage* level.

Range:      Von Voltage: 0.00-rating voltage

## Von Latch

**Description** When Von Latch is set to ON, the load will continue to sink current after being “latched”, even if the voltage drops below the Von Voltage threshold level.

When Von Latch is set to OFF, the load will turn off when the voltage drops below the Von Voltage threshold level.

By default Von Latch is set to OFF.

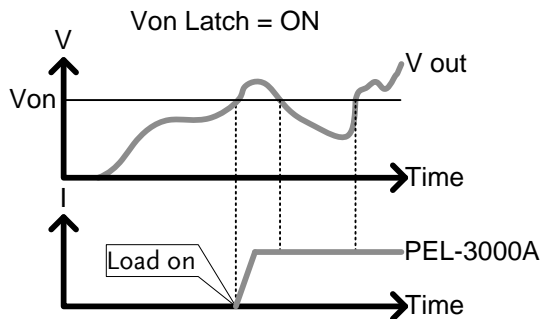
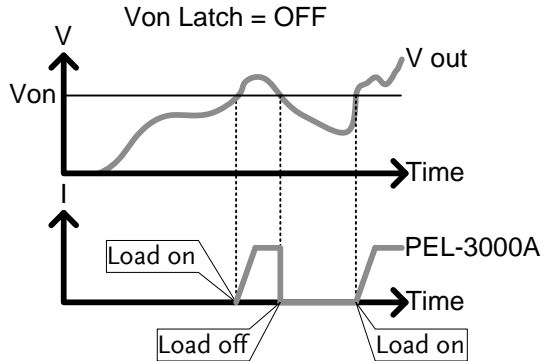

- Operation**
1. Press **Main** > *Configure*[F5] > *Other*[F2] and set the *Von Latch* setting.

Range: Von Latch: OFF, ON

## Von Delay

---

**Description** Von Delay is the amount of time the unit will wait before turning the load on after the Von Voltage threshold has been latched. This will prevent overshoot current from affecting the Von Voltage threshold.

**Operation** 1. Press  > *Configure*[F5] > *Other*[F2] and set the *Von Delay* time.

**Range:** Von Delay: OFF, 2.0-60ms(CC, CV, CP mode and CR mode for PEL-3000AH)  
OFF, 5.0-60ms (CR mode for PEL-3000A)



Note

CR mode can have the delay time set separately from the other modes (called *Von Delay -CR* when in CR mode).

## Timer Functions

### Count Time

---

**Description** When Count Time is set to on, it will count the elapsed time from when the load was turned on to when it was turned off.

- This function is applicable to manual and automatic shutdown (such as from protection functions such as UVP etc.)
- The elapsed time will be shown in the display Measurement area.

**Operation** 1. Press  > *Configure*[F5] > *Other*[F2] and turn the *Count Time* on or off.

**Range:** ON, OFF



Display

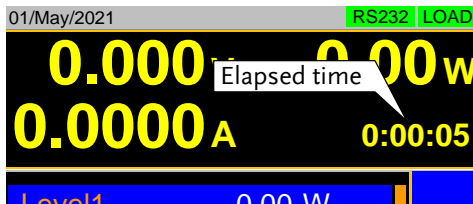

### Cut Off Time

Description

The Cut Off Time function will turn the load off after a set-amount of time. After the load has been turned off, a popup screen will display the voltage level when the load was turned off.

Operation

1. Press **Main** > *Configure*[F5] > *Other*[F2] and set the *Cut Off Time*.

Range: OFF, 1 second - 999 hours:59 minutes:59 seconds

Display

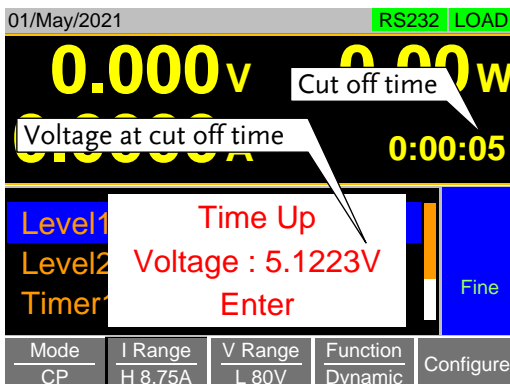

## Auto Load Configuration



---

**Description** The PEL-3000A/AH can be configured to automatically load the last program, normal sequence, fast sequence or load setting at startup.

By default, this setting is disabled.

---

### Operation

1. Press  +  > Load[F2].
  2. Turn *Auto Load On* or *Off*.
    - When set to OFF, the Auto Load setting is disabled.
  3. Select the *Auto Load On* configuration.
    - This will select whether the PEL-3000A/AH will automatically load the last program, normal sequence, fast sequence or load settings.
- 

Auto Load On:            Load, Prog, NSeq, FSeq

---

## Load Off (Mode) and Load Off (Range)

---

**Description** By default the load will automatically turn off when the either the operating mode (CC, CV, CR, CP) or the range (I range, V range) is changed.



To allow the load to stay on when the operating mode is changed, set the *Load Off (Mode)* setting to *OFF*.

To allow the load to stay on when the current or voltage range is changed, set the *Load Off (Range)* setting to *OFF*.

By default, these settings are set to *ON*.

---

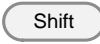
### Operation

1. Press  +  > *Load*[F2].
  2. Select *Load Off (Mode)* setting.
    - When set to *OFF*, the load will stay on when the operating mode is changed.
- 

*Load Off (Mode)*:      *OFF, ON*

---

3. Select *Load Off (Range)* setting.
    - When set to *OFF*, the load will stay on when the range is changed.
- 

*Load Off (Range)*:      *OFF, ON*

## Step Resolution Configuration

There are two different ways to set the resolution when using the scroll wheel to edit parameters. Step Mode and Cursor Mode. Step Mode is the default method. Only one mode can be active at a time; When one mode is active, the other mode is deactivated.

### Cursor Mode Configuration

**Description** Cursor mode allows you to edit the selected parameter one digit at a time. When editing a parameter, pressing the scroll wheel determines which digit is selected. Turning the scroll wheel will then edit the parameter by the step resolution of the digit.

See the Conventions section on page 47 for operation details.

**Operation**

1. Press **Main** > *Configure*[F5] > *Next Menu*[F4] > *Knob*[F2] and set the *Status* setting is set to *Cursor*.

**Display**

01/May/2021		RS232	LOAD
<b>Configure</b>		CC	8.75A
		80V	Static
Status	Cursor		
CCH Step	0.0300 A		
CCM Step	0.00300 A		
CCL Step	0.300 mA		
CRH Step	3.00 mS		
Parallel	Knob	External	Previous Menu

## Step Mode Configuration

---

**Description** When set to Step Mode, the voltage, current, resistance and power settings can have the step resolution configured. The step resolution refers to the step resolution of the coarse adjustment for these settings. The fine adjustment cannot be configured.

See the Conventions section on page 47 for details on how to switch between coarse and fine adjustment modes.

**Settings** The step resolution of each setting is configured separately for each current range.

Settings	Description
CCH Step	CC mode, IRange = High
CCM Step	CC mode, IRange = Middle
CCL Step	CC mode, IRange = Low
CRH Step	CR mode, IRange = High
CRM Step	CR mode, IRange = Middle
CRL Step	CR mode, IRange = Low
CVH Step	CV mode, VRange = High
CVL Step	CV mode, VRange = Low
CPH Step	CP mode, IRange = High
CPM Step	CP mode, IRange = Middle
CPL Step	CP mode, IRange = Low

Operation

1. Press **Main** > *Configure*[F5] > *Next Menu*[F4] > *Knob*[F2] and make sure the *Status* setting is set to *Step*.
2. Set the desired step resolution settings. (The step resolution settings are only available when *Status=Step (coarse/fine)*)
  - For example if the step resolution for CCM Step is 0.5A, then the resolution can be incremented in 0.5A steps.

Display

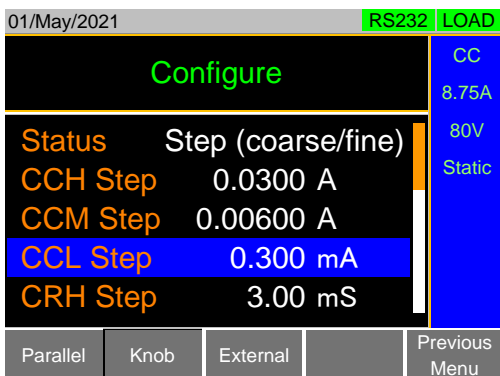

## Protection Settings

The Protection settings are used to prevent damage to the unit or the DUT by excessive current, voltage or power.

An alarm is generated and a message is displayed on the screen when a protection setting is tripped. When an alarm is activated, the load is turned off (or limited), and the ALARM STATUS pin of the J1 connector on the rear panel (pin 16) turns on (open collector output by a photocoupler). The protection settings can be used regardless of whether the remote sense connections are used or not.

### OCP

Description	<p>For OCP, the PEL-3000A/AH can be configured to either limit the current or turn off the load.</p> <p>The OCP levels can be set to 10% higher than the rating current.</p>
Operation	<p>1. Press  &gt; <i>Configure</i>[F5] &gt; <i>Protection</i>[F1] and set the <i>OCP Level</i> and <i>OCP Setting</i>.</p> <hr/> <p>Range:            OCP Level: Rating current + 10%</p> <p>                     OCP Setting: LIMIT, Load Off</p>
Alarm	<ul style="list-style-type: none"> <li>• When <i>OCP Setting</i> is configured to <i>Load Off</i>, a message will be displayed on the screen when OCP is tripped. The Enter key must be pressed to clear the alarm message.</li> <li>• When configured to <i>LIMIT</i>, OCP will be displayed on the screen when the OCP is tripped and the current will be limited to the <i>OCP Level</i> setting.</li> </ul>

Display

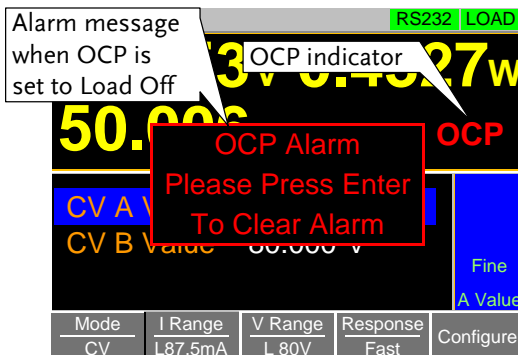

## OPP

**Description** For OPP, the PEL-3000A/AH can be configured to either limit the power or turn off the load.

The OPP levels can be set to 10% higher than the rating power.

**Operation**

1. Press **Main** > *Configure*[F5] > *Protection*[F1] and set the *OPP Level* and *OPP Setting*.

Range:           OPP Level: Rating power + 10%  
                   OPP Setting: LIMIT, Load Off

**Alarm**

- When *OPP Setting* is configured to *Load Off*, a message will be displayed on the screen when OPP is tripped. The Enter key must be pressed to clear the alarm message.
- When configured to *LIMIT*, OPP will be displayed on the screen when the OPP is tripped and the power will be limited to the *OPP Level* setting.



Display

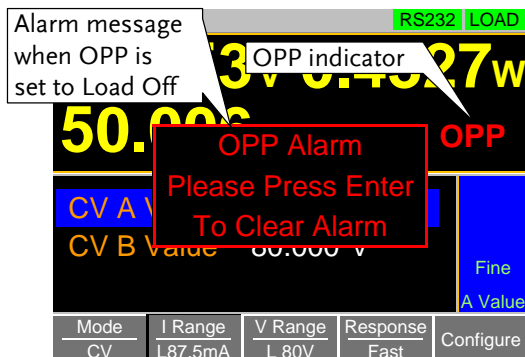

## UVP

Description

If the UVP is tripped, the PEL-3000A/AH will turn off the load.

The UVP levels can be set from 0V to 10% higher than the rating voltage.

Operation

1. Press **Main** > *Configure*[F5] > *Protection*[F1] and set the *UVP Level*.

Range: UVP Level: OFF, 0-Rating voltage + 10%

Alarm

- The UVP indicator and a message will only appear on the screen when the input voltage is below the UVP level. The Enter key must be pressed to clear the alarm message.
- To clear the UVP indicator, remove the cause of the under voltage - i.e., increase the input voltage.

Display

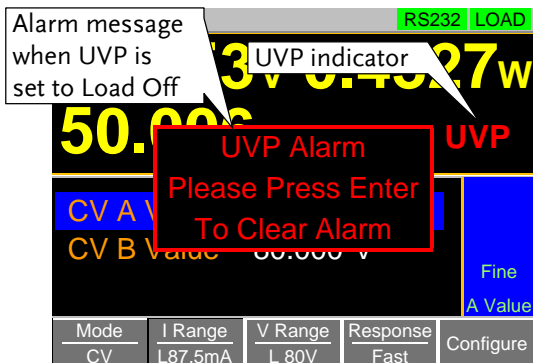

## UVP Ring Time

**Description** The UVP Ring Time settings allows the UVP alarm to keep sounding for a user-set amount of time after the UVP has been tripped.

The alarm will continue ringing for the set amount of time even if the voltage rises back above the UVP level~ unless the alarm is cleared manually.

**Operation**

1. Press **Main** > *Configure*[F5] > *Protection*[F1] and set the *UVP Ring Time*.

Range: UVP Ring Time: OFF, 0-600s

**Alarm**

- When the voltage dips below the UVP level, the UVP indicator and message will appear on the screen. The UVP buzzer will sound if UVP Ring Time is set. Under this scenario the following outcomes are possible:
2. Pressing the Enter key will clear the message and the buzzer. The UVP indicator will remain on the display until the voltage level rises back above the UVP level.
  3. If the UVP Ring Time is allowed to elapse, the buzzer will stop. However the UVP indicator

and message will remain on screen until the message is cleared.

- If the voltage rises back above the UVP level, the UVP indicator will be cleared from the display but the buzzer will continue to sound until the UVP Ring Time has elapsed and the message will remain until it has been cleared.

#### Display

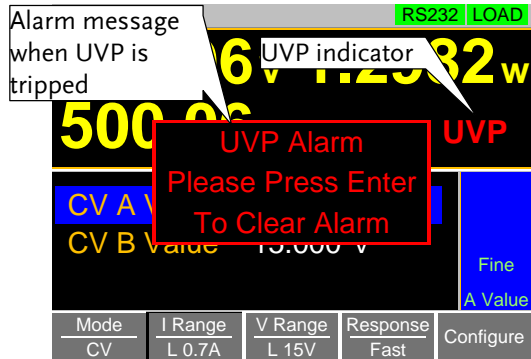

## OVP

**Description** If the OVP is tripped, the PEL-3000A/AH will turn off the load.

The OVP levels can be set from 0V to 10% higher than the rating voltage.

**Operation**

1. Press **Main** > *Configure*[F5] > *Protection*[F1] and set the *OVP Level*.

Range: OVP Level: OFF, 0-Rating voltage + 10%



**Note**

To turn OVP off, set the OVP voltage greater than the current rating voltage + 10%.

**Alarm**

- The OVP indicator and a message will only appear on the screen when the input voltage is below the UVP level. The Enter key must be pressed to clear the alarm message.
- To clear the OVP indicator, remove the cause of the over voltage - i.e., reduce the input voltage.

**Display**

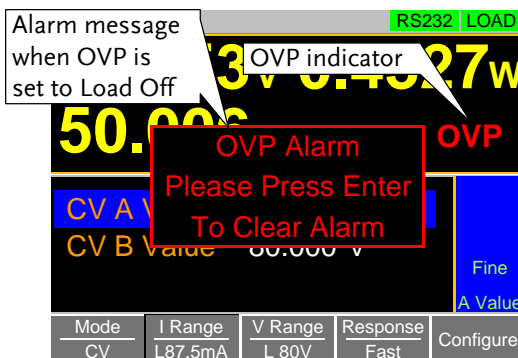

## UnReg

---

**Description** The UnReg error message will appear on the display when the electronic load is operating in an unregulated state.

- Alarm**
- The UnReg indicator will appear on the display when the set load is inadequate for the source.
  - To clear the UnReg indicator, increase the load or reduce the load requirements.

**Display**

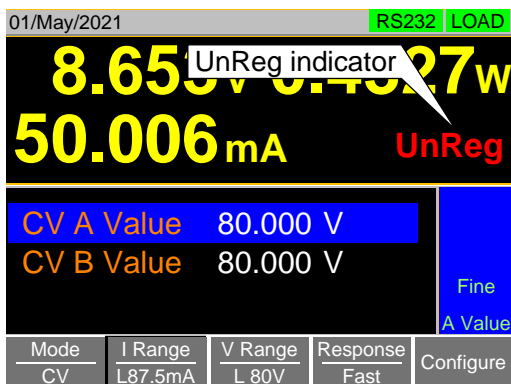

## Para

**Description** The Para error message will appear on the display when the PEL-3000A/AH is used in parallel and if an error is produced.

- Alarm**
- The Para error message indicates one of the following possible conditions: UnReg, ROCP, OTP.
  - To clear the Para indicator, remove the cause of the alarm.

## Display

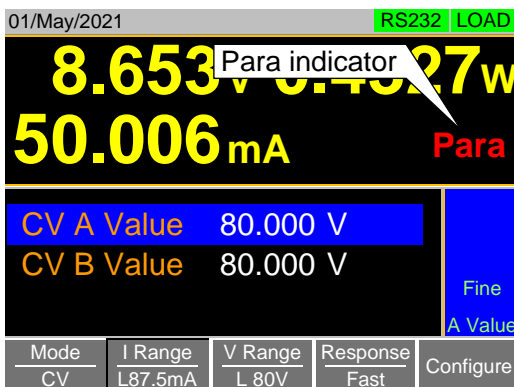

## RVP

**Description** If the RVP is tripped, the PEL-3000AH series will turn off the load.

- Alarm**
- The RVP error message indicates when the terminal voltage is negative.
  - The Enter key must be pressed to clear the alarm message.

**Display**

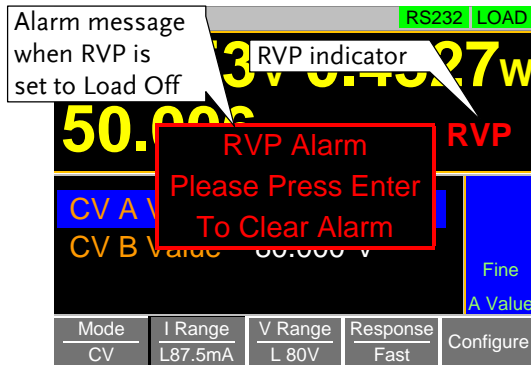

## System Settings

The following section covers a number of miscellaneous system settings such as:

- Speaker settings
- Display settings
- Alarm tone settings
- Input control settings
- Language settings
- Input/output trigger settings

All system settings are accessible in the Utility menu.

## Sound Settings



### Speaker Settings

---

Description	Turns the speaker sound on or off for the user interface, such as key press tones and scrolling tones.
-------------	--

---

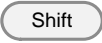
#### 2. Operation

1. Press  +  > *Other*[F5].
2. Set the *Speaker* settings on or off.
  - When set to OFF, the speaker setting will not disable the tones for Go-NoGo or protection alarms.





## Alarm Tone Settings

---

**Description** The alarm tone for the unit can be turned on or off in the utility menu. The alarm tone can be set separately for the protection settings (OCP, OPP, UVP, OVP), Go-NoGo testing or for when the unit is operating in an unregulated state (see page 91).

---

### Operation

1. Press  +  > *Other*[F5].
  2. Set the alarm tone settings on or off.
    - The alarm tone settings ignore the *Speaker* setting.
- 

Alarm Tone:	ON, OFF
UnReg Tone:	ON, OFF
Go_NoGo Tone:	ON, OFF

---



## Display Settings

### Panel

---

**Description** Set the Panel.

### Operation

1. Press  +  > *Other*[F5].
  2. Set the Panel type.
- 

Range:	A or B
--------	--------



---

## Contrast and Brightness

---

**Description** Sets the contrast level.

### Operation

1. Press  +  > *Other*[F5].
  2. Set the *Contrast* and *Brightness* settings.
-

Range: Contrast: 3 - 13 (low - high)  
 Brightness: 50 - 90 (low - high)



Note

If the brightness and contrast cannot be adjusted, please switch panel type A or type B.

## Control Settings

### Description

The Knob Type setting determines if values are updated immediately as they are edited or if they are only updated after the Enter key is pressed.

The *Updated* setting is applicable for when the load is already on and the user wishes to change the set values (current, voltage, etc.) in real time.

The *Old* setting will only update the values after the Enter key is pressed.

### Operation

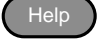
1. Press  +  > *Other*[F5].
2. Set the *Knob type* and *Slave knob* settings.



Range: Knob type: Updated, Old

## Language Settings

### Description

The PEL-3000A/AH supports only English.

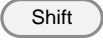
### Operation

1. Press  +  > *Other*[F5].
2. Set the *Language* setting.

Supported languages: English

## Input/ Output Trigger Settings



### Trigger In Delay

---

**Description** The Trig In Delay setting determines how long to delay any action after a trigger is received.

---

**Operation**

1. Press  +  > *Other*[F5].
  2. Set the *Trig In Delay* setting.
- 

Range: 0.01~100ms, Default: 0.01ms



---

### Trigger Out Width

---

**Description** The Trigger Out Width setting sets the trigger output signal's pulse width.

**Operation**

1. Press  +  > *Other*[F5].
  2. Set the *Trig Out Width* setting.
- 

Range: 2.5~5000.0μs, Default: 10μs

---



### Measure Average

---

**Description** The Measure Average setting is used to set the speed of the measurement display. The setting has three modes. They are slow, normal and fast

The default mode for Measure Average setting is slow.

**Operation**



1. Press  +  > *Other*[F5].
  2. Set the *Measure Average* setting.
-

Slow	Average 1024 times
Normal	Average 64 times
Fast	Average 4 times
Default	Normal mode

### Measure Period

**Description** The Measure Period setting is used to set the update rate of the measurement. The setting has three modes. They are 20ms, 200ms and 1000ms. The default mode for Measure Period setting is 200ms.

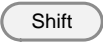
**Operation**

1. Press  +  > *Other*[F5].
2. Set the *Measure Period* setting.



20ms	Measure update rate is set to 20ms
200ms	Measure update rate is set to 200ms
1000ms	Measure update rate is set to 1000ms
Default	200ms

### RVP Load Off

**Description** When the input terminal detects reverse voltage, a warning message will be displayed and the RVP Load Off setting can be set to turn on or off the load as well. The setting has two modes. They are ON and OFF.

The default mode for RVP Load Off setting is ON.

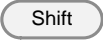
**Operation**

1. Press  +  > *Other*[F5].
2. Set the *Load Off* setting.

ON	When the input terminal detects the reverse voltage, a warning message will be displayed on the screen and the load will be turned off.
----	---

---

OFF	When the input terminal detects the reverse voltage, a warning message will be displayed on the screen but the load will not be turned off.
-----	---

---

## Go-NoGo

The Go-NoGo configuration is used to create pass/fail limits on the voltage or current input. If the voltage/current exceeds the pass/fail limits, an alarm will be output.

The Go-NoGo configuration can be used with the Program function to create complex pass/fail tests.

### Setting the Go-NoGo Limits

Description	The Go-NoGo setting limits can be set as either discrete high & low values or as a percentage offset from a center value.										
Operation	<ol style="list-style-type: none"> <li data-bbox="334 691 908 735">1. Press  &gt; <i>Configure</i>[F5] &gt; <i>Go-NoGo</i>[F3].</li> <li data-bbox="334 759 936 979">2. Select <i>Entry Mode</i> and choose how to set the pass/fail limits. <ul style="list-style-type: none"> <li data-bbox="334 839 936 900">• Value will allow you to set the limits as discrete values.</li> <li data-bbox="334 919 936 979">• Percent will allow you to set the limits as a percentage offset from a center value.</li> </ul> </li> <li data-bbox="334 1003 902 1064">3. If <i>Entry Mode</i> was set to <i>Value</i>, Set the <i>High &amp; Low</i> limit values. <table border="1" data-bbox="334 1075 751 1150"> <tr> <td data-bbox="334 1075 396 1106">High:</td> <td data-bbox="486 1075 751 1106">0-rating current/voltage</td> </tr> <tr> <td data-bbox="334 1114 385 1144">Low:</td> <td data-bbox="486 1114 751 1144">0-rating current/voltage</td> </tr> </table> </li> <li data-bbox="334 1174 911 1235">4. If <i>Entry Mode</i> was set to <i>Percent</i>, Set the <i>Center voltage/current</i> and <i>High, Low %</i> values. <table border="1" data-bbox="334 1246 852 1347"> <tr> <td data-bbox="334 1246 415 1276">Center:</td> <td data-bbox="486 1246 751 1276">0-rating current/voltage</td> </tr> <tr> <td data-bbox="334 1284 396 1315">High:</td> <td data-bbox="486 1284 852 1315">0-100% of center voltage/current</td> </tr> <tr> <td data-bbox="334 1323 385 1353">Low:</td> <td data-bbox="486 1323 852 1353">0-100% of center voltage/current</td> </tr> </table> </li> </ol>	High:	0-rating current/voltage	Low:	0-rating current/voltage	Center:	0-rating current/voltage	High:	0-100% of center voltage/current	Low:	0-100% of center voltage/current
High:	0-rating current/voltage										
Low:	0-rating current/voltage										
Center:	0-rating current/voltage										
High:	0-100% of center voltage/current										
Low:	0-100% of center voltage/current										

5. Set the Delay Time.
  - The delay time setting will delay activating the Go-NoGo testing by a specified amount of time.
  - The delay setting can compensate for startup oscillation and other instabilities during startup.

---

Delay Time      0.0-1.0 seconds (0.1s resolution)

---



Note

When the Main settings are saved or recalled, the Go-NoGo settings are also saved/recalled. See the Save/Recall chapter for details, page 103.

## Running a Go-NoGo Test

---

Description	<p>Go-NoGo test results are displayed in the measurement panel.</p> <ul style="list-style-type: none"> <li>• GO indicates pass (good).</li> <li>• NG indicates fail (no good).</li> </ul>
Operation	<ol style="list-style-type: none"> <li>1. Press <b>Main</b> &gt; <i>Configure</i>[F5] &gt; <i>Go-NoGo</i>[F3].</li> <li>2. Set <i>SPEC Test</i> to ON.           <ul style="list-style-type: none"> <li>• When SPEC Test is ON, SPEC will appear in the Operation Status Panel. This means the unit is ready for Go-NoGo testing.</li> </ul> </li> <li>3. Turn the load on.           <ul style="list-style-type: none"> <li>• The test starts from the time the load was turned on + the Delay Time.</li> </ul> </li> </ol>

Display:  
GO

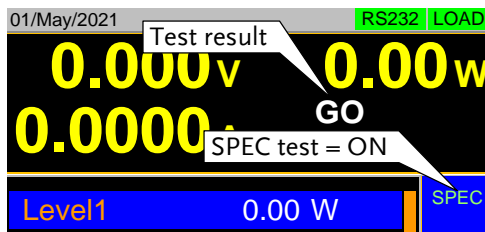

Display:  
NG

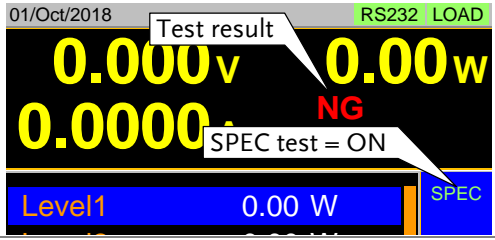



## Save Recall

The PEL-3000A/AH can save and recall system settings, preset data, memory data, Go-NoGo settings as well as normal and fast sequences to internal memory or to USB.

### File Structure

**Description** The PEL-3000A/AH file system can save files to internal memory (Media | Memory) and external memory (Media | USB).

To save or recall Memory, Setup or Preset data, the PEL-3000A/AH uses a three tier system where files are saved or recalled in the following order:

Active settings <> Internal memory <> USB.

This can be best described in the picture below.

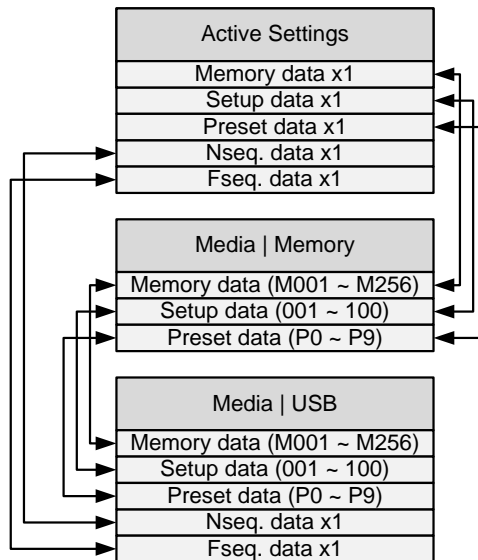

**Example** To load Preset Data P7 from USB, you must first load Preset Data P0-P9 to internal memory, then from internal memory load Preset P7 to be the

active preset setting.

For normal and fast sequences however, files can be saved or recalled directly to/from USB memory.

## File Types

**Memory Data**      Memory data contains general settings and is used for creating programs. Memory Data contains the operating mode, range, response and Go/NoGo settings. Memory data can be stored both internally and externally to USB. Preset data and Memory data store the same contents.

Internal Format	M001 - M256
External Format	model no_file no.M example: 3021(H)_01.M

**Setup Data**      Setup data contains all general configuration settings, protection settings, program and program chain settings, as well as parallel configuration settings.

Internal Format	1 - 100
External Format	model no_file no.S example: 3021A/AH_00.S

**Preset Data**      Preset Data contains the same settings as the Memory Data. Preset Data contains the operating mode, range, response and Go-NoGo settings.

Internal Format	P0 - P9
External Format	model no_file no.P example: 3021A/AH_00.P

**NSeq Data**      NSeq Data contains the Normal Sequence settings.

Internal Format	None
External Format	model no_file no.N example: 3021A/AH_00.N

**FSeq Data**      FSeq Data contains the Fast Sequence settings.

Internal Format	None
External Format	model no_file no.F example: 3021A/AH_00.F

## Saving Files to Internal Memory

**Description** When saving Memory, Setup or Preset Data to internal memory, the currently active setting is saved to one of the internal memory slots.

Memory Data has 256 memory slots, Setup Data has 100 memory slots and Preset Data has 10 memory slots.

**Memory Data Example**

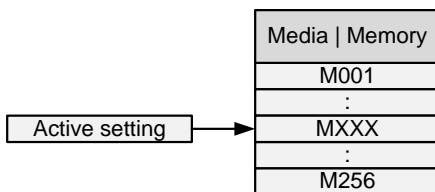

**Display**

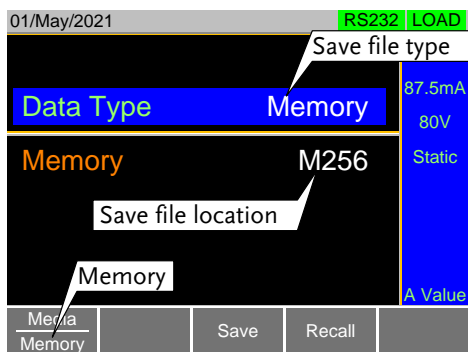

**Operation**

1. Press **Shift** + **File FUNC**.
2. Select Memory with the *Media[F1]* soft-key.
3. Select the *Data Type* and choose the type of file to save.

Data Type: Memory Data, Setup Data,  
Preset Data

---

4. Select which internal memory location to save the file.

---

Memory: M001 - M256

Setup Memory: 1 - 100

Preset: P0 - P9

---

5. Press *Save*[F3] to save.

- Save Ok will be displayed when the save has been completed.
- 



Note

Normal Sequence and Fast Sequence data cannot be recalled from or saved to an internal memory slot.

## Saving Files to USB Memory

**Description** When saving files to USB memory, all the memory locations from the selected data type are saved as a single file to the USB file path directory.

**Memory Data Example**

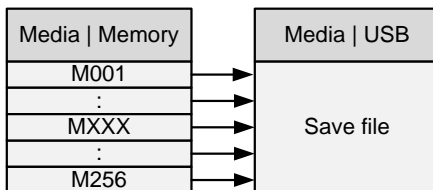

For example, Memory Data M001 to M256 is saved to a single file on USB.

**Display**

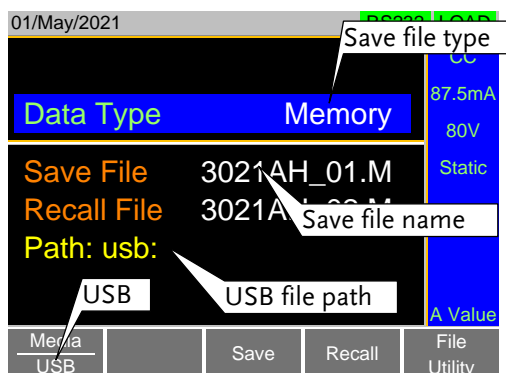

**Operation**

1. Insert a USB drive into the USB port.
  2. Press **Shift** + **File FUNC**.
  3. Select USB with the *Media[F1]* soft-key.
  4. Select the *Data Type* and choose the type of file to save.
- Data Type:** Memory Data, Setup Data, Preset Data, NSeq, FSeq

5. Select *Save File* and choose a save filename.
    - Turn the scroll wheel to increase/decrease the file number.
- 

Memory:	Model_file number.M
Setup Memory:	Model_file number.S
Preset:	Model_file number.P
NSeq:	Model_file number.N
FSeq:	Model_file number.F

---

6. Press *Save[F3]* to save.
    - The file will be saved to the USB file path.
    - Save Ok will be displayed when the save has been completed.
    - If saving-over an existing file you will be asked to confirm the save. Press *Save[F3]* to confirm.
- 

#### File Utilities

7. Press *File Utility[F5]* to access the file utility. See page 112 for details.
  - Change the USB path.
  - Rename files or create directories.

## Recalling Files from Internal Memory

**Description** When recalling Memory, Setup or Preset Data from the internal memory slots, the recalled file becomes the active setting.

Memory Data has 256 memory slots, Setup Data has 100 memory slots and Preset Data has 10 memory slots.

**Memory Data Example**

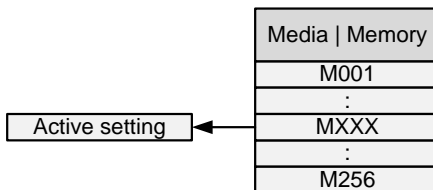

**Display**

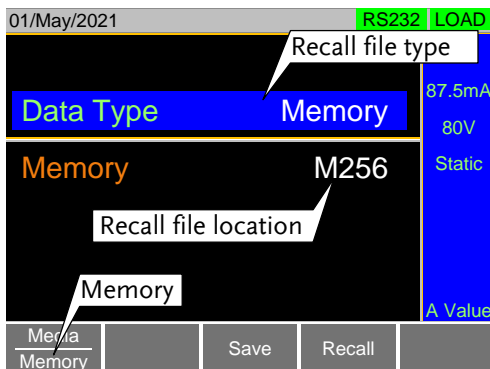

**Operation**

1. Press **Shift** + **File FUNC**.
2. Select Memory with the *Media[F1]* soft-key.
3. Select the *Data Type* and choose the type of file to recall.

**Data Type:** Memory Data, Setup Data, Preset Data

4. Select which memory slot to recall from.

Memory:	M001 - M256
Setup Memory:	1 - 100
Preset:	P0 - P9

5. Press *Recall*[F4] to recall.

- For Memory Data and Preset Data, a popup window will appear. Press the **Enter** key to confirm the recall.



Note

Normal Sequence and Fast Sequence data cannot be recalled from or saved to an internal memory slot. They can, however, be recalled directly from USB memory. See the next section below for details.

### Recalling Files from USB Memory

#### Description

When recalling Memory, Setup or Preset files from USB memory, a single file from the USB drive will overwrite all the existing memory slots for the selected data type.

For Normal or Fast Sequence files, the recalled file becomes the active setting as these types of files don't have an internal memory slot.



Caution

You can only recall files from the same model.

#### Memory Data Example

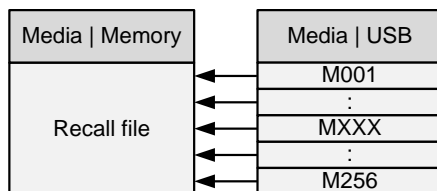

For example, if the file 3021A/AH\_01.M is recalled, all the Memory Data from M001 to M256 will be overwritten.



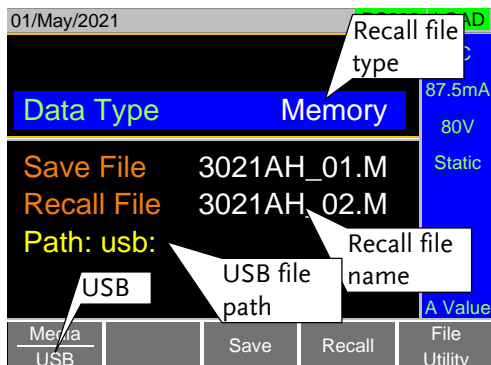

## Display



## Operation

1. Insert a USB drive into the USB port.

2. Press  + .
3. Select *USB* with the *Media[F1]* soft-key.
4. Select the *Data Type* and choose the type of file to recall.

---

Data Type:      Memory Data, Setup Data,  
                         Preset Data, NSeq, FSeq

---

5. Select *Recall File* and choose a filename.
  - Turn the scroll wheel to increase/decrease the file number.

---

Memory:              Model\_file number.M  
Setup Memory:      Model\_file number.S  
Preset:                Model\_file number.P  
NSeq:                  Model\_file number.N  
FSeq:                    Model\_file number.F

---

6. Press *Recall[F4]* to recall.
  - Recall Ok will be displayed when the recall has been completed.

- |                |   |
|----------------|---|
| File Utilities | <p>7. Press <i>File Utility</i>[F5] to access the file utility. See page 112 for details.</p> <ul style="list-style-type: none"> <li>• Change the USB path.</li> <li>• Rename files or create directories.</li> </ul> |
|----------------|---|



Caution

If “Machine Type Error” is displayed it indicates that the file that you are trying to recall originated from a different model. You can only recall files from the same model.

### Recall Memory Safety Setting

---

Description	<p>By default when you try to recall <i>preset settings</i> from internal memory, a message will appear asking you to press the Enter key to confirm. This is the standard safety measure to ensure that the wrong setting is not recalled. This safety measure can be disabled by setting the Mem. Recall setting to “Direct”.</p>
-------------	---

Operation	<p>1. Press  &gt; <i>Configure</i>[F5] &gt; <i>Other</i>[F2] and set the <i>Mem. Recall</i> setting.</p>
-----------	---

Range:            Safety, Direct



Note

This setting only applies when recalling preset settings from internal memory, either by using the Presets keys (P0 - P9) or by using the File menu. See page 114 and 109.

### File Utility

---

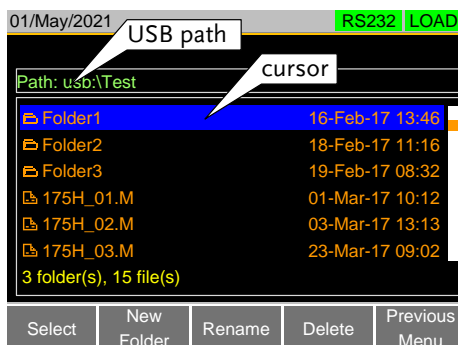

Description	<p>The file utility allows you to create new folders, rename files and set the USB path directory.</p> <p>It is only available for use with the USB external memory.</p>
-------------	--

Display

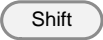

Access the File Utilities Menu

1. Insert a USB drive into the USB port.

2. Press  +  > *File Utility*[F5].

- The file utilities screen appears.

Create a new Folder

3. Press *New Folder*[F2] to create a new folder.

- Use the on-screen display to enter the filename.
- A maximum of 8 characters.

Rename a Folder

4. Use the scroll wheel to move the cursor to the file/folder you wish to rename.

5. Press *Rename*[F3].

- Use the on-screen display to enter the filename.
- A maximum of 8 characters.

Delete File or Folder

6. Use the scroll wheel to move the cursor to the file/folder you wish to delete.

7. Press *Delete*[F4].

8. Press *Delete*[F4] again to confirm the deletion.

## Preset

The Preset key is used to save and recall preset settings from the front panel quickly. The presets have the same contents as memory data, this includes the operating mode, range, configuration settings and Go-NoGo settings.



### Quick Preset Save

---

**Description** The current settings can be saved to P0 - P9 using the Preset key and the number pad.

---

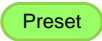
**Operation**

1. Press  and hold  -  until a beep is heard.
- The beep indicates that the setting was saved to the selected preset.





### Quick Preset Recall

---

**Description** Presets P0 to P9 can be recalled quickly by using the Preset key and the number pad.

---

**Operation**

1. Press  +  - .
2. Press  again to deactivate the preset key.

## Default Settings



### Factory Default Settings

---

**Description** The factory default settings can be recalled at any time. See page 252 for a list of the factory default settings.

---

**Operation**

1. Press  + .
2. Select *Default* with the *Media[F1]* soft-key.
3. Press *Factory Default[F2]*.
4. Press *Factory Default[F2]* again to confirm.



### User's Default Setting

---



**Description** The currently active settings can be set as the "User's Default" settings.

---

**Save User's Default Setting**

1. Press  + .
  2. Select *Default* with the *Media[F1]* soft-key.
  3. Press *Save[F3]*.
  - The User's Default is saved immediately.
- 

**Recall User's Default Setting**

1. Press  + .
2. Select *Default* with the *Media[F1]* soft-key.
3. Press *Recall[F4]*.
4. Press *Recall[F4]* again to confirm.
- A User's Default must be saved first before it can be recalled.

# FUNCTION MENU

---

Function Menu Overview .....	117
Select a Function .....	117
Turning on the Load with the Selected Function .....	119
Complete Ring Time .....	120
NSEQ Timer .....	121
Program .....	123
Program Overview .....	123
Create a Program .....	125
Create a Program Chain .....	128
Running a Program or Chain .....	129
Sequence .....	131
Normal Sequence Overview .....	131
Timing Edit Configuration .....	135
Data Edit Configuration .....	137
Running a Normal Sequence .....	138
Fast Sequence Overview .....	141
Timing Edit Configuration .....	145
Data Edit Configuration .....	146
Running a Fast Sequence .....	148
OCP Test Automation .....	150
OPP Test Automation .....	157
BATT Test Automation .....	164

## Function Menu Overview

The Function menu can be used as a quick access hub to the Program, Normal Sequence, Fast Sequence, OCP, OPP or BATT menus.

It is also used to set Function specific settings:

- Function Select.
- Complete Ring Time.
- NSEQ Timer.

### Select a Function

**Description** The Function Select option is used to turn a Program, Normal Sequence, Fast Sequence, OCP, OPP, BATT or MPPT Test function on or off. Before one of these functions is turned on, they should be configured beforehand. See page 123, 131, 150 to configure Programs, Sequences or the OCP function, respectively.

**Function Select Screen**

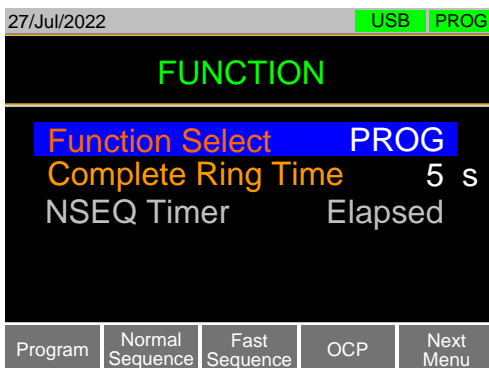

**Operation**

1. Press  .
2. Select *Function Select* and choose a function to

turn on or choose to turn off the last function.

Range OFF, PROG, NSEQ, FSEQ, OCP



Note

- After a function is selected, it is then “turned on”.
- **PROG**, **NSEQ**, **FSEQ**, **OCP**, **OPP**, **BATT** or **MPPT** will appear at the top of the display when the selected function is on.
- When in the Main menu, the **PROG**, **NSEQ**, **FSEQ** or **OCP** icon will appear prominently on the display to remind the operator that a function is still on. A normal load cannot be turned on when a Function mode is turned on.

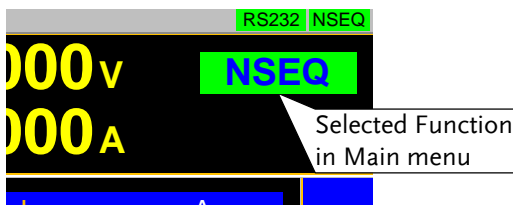





- Be sure to turn the selected function off to return to normal operation.



## Turning on the Load with the Selected Function

---

- Description
- When a function is turned on, the load can be turned on (with the selected function) by pressing  + . This can be done at anytime.
    - The  key will turn orange when the load is "on".
    - The load can be turned off again by pressing the  key.
    - The **PROG**, **NSEQ**, **FSEQ**, **OC**, **OPP**, **BATT** or **MPPT** icon turns orange when the load is turned on.
    - The selected function will need to be turned off before a "normal" load operation can be performed.

Display

LOAD on with the selected function active

01/May/2021

RS232 **PROG**

**1 500V** **1 50**

## Complete Ring Time

**Description** The Complete Ring Time function turns the alarm on for a user-set amount of time after a program, sequence or OCP function has finished.

**Function Select Screen**

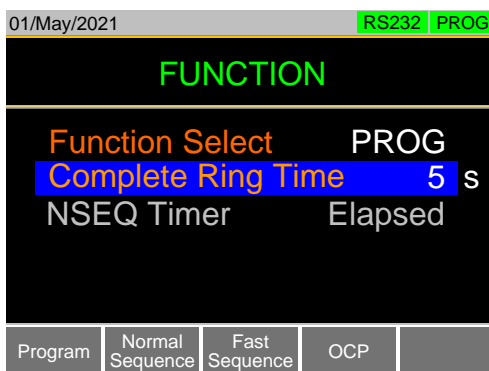

**Operation**

1. Press **FUNC**.
2. Select *Complete Ring Time* and select how long the alarm should ring after a function has completed.

Range OFF, 1 ~ 600s, Infinity

Default Off

- The Complete Ring Time setting applies to all the functions.



Note

The alarm may not sound if Alarm Tone is turned off in the Utility>Other menu. See page 95 for setting details.

## NSEQ Timer

---

**Description** The NSEQ Timer setting determines whether the timer for the Normal Sequence function displays the elapsed time or the remaining time for both the current step and the overall test time for the sequence.

---

**Function Select Screen**

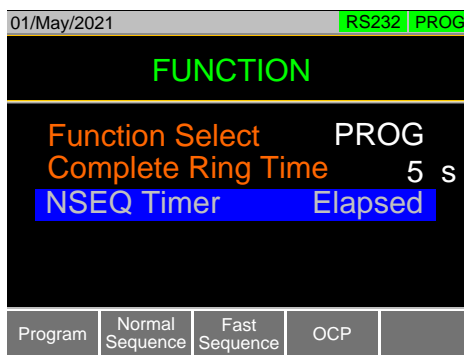

**Operation**

1. Press **FUNC**.
  2. Select *NSEQ Timer* and select whether the current step and total test time is displayed as elapsed time or remaining time.
- 

Range	Elapsed, Remaining
Default	Elapsed

---

Display example

01/May/2021 RS232 NSEQ

**0.000V**      **0.00W**

**0.0000A**      0:00:05

---

Run N. Sec: 01      Seq. No.: 01

0:00:05      3

0:00:05      0001

Continue



Note

When the total test time is >1000 hours, then the total test time will always be displayed as the elapsed time.

## Program

The PEL-3000A/AH can create programs that are designed to step-through up to 16 pre-set load operations. The program function is a powerful tool that can allow you to perform a number of different operations in succession.

- The execution time of each step is user-defined.
- Programs can be chained together to make larger programs.
- Up to 16 programs can be created for a program chain.

See page 103 for saving load operations.

### Program Overview

---

Description	<p>When you run a program, you are essentially executing up to 16 different load operations consecutively. Each of the different load operations are “steps” in the program. A program starts at step 01 and ends at step 16.</p> <ul style="list-style-type: none"><li>• A program recalls the operating mode, range, static/dynamic mode, response speed and other settings of each step from stored memory. It also recalls the Go-NoGo settings.</li><li>• The same memory settings can be used for multiple steps.</li><li>• The execution time of each step is configurable.</li><li>• Applies the Go-NoGo settings for each step.</li><li>• Each step must be executed in order.</li><li>• Each step can be configured to automatically go to the next step or wait for confirmation from the user before proceeding to the next step.</li><li>• Individual steps can be skipped.</li><li>• Programs can be linked together to make</li></ul>
-------------	--

---

program chains.

- Program chains need not be executed in order.
- There are 16 steps to a program.
- There are up to 16 programs to a chain.

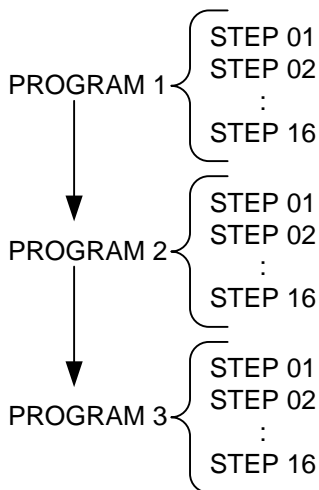

**Setting Overview** A program contains the following settings for each step:

- **Memory:** the memory location of the load operation for the selected step (M001-M256).
- **Run:** Designates the run setting for the step (Auto, Manual, Skip).
- **On-Time:** Sets the run time of the test.
- **Off-Time:** Sets the off time between steps.
- **P/F-Time:** Sets the testing pass/fail delay time for GoNo Go testing.
- **Short-Time:** Sets the shorting time for the step, if any.

**Timing Diagram for Single Step** Below is a timing diagram of a single step in a program.

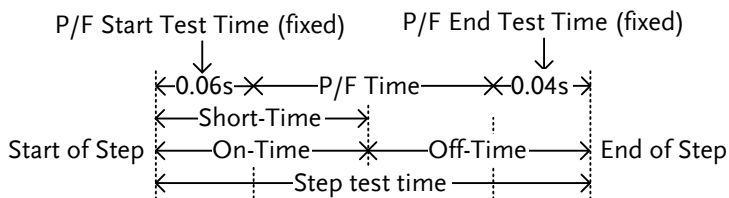

## Create a Program

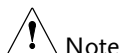

Note

Before creating a program, the settings for each step must first be created and saved to internal memory (M001-M256). See the save recall chapter for further details, page 103.

Program Setting  
Display Overview

Program number      Step number in selected program

Timing Edit for Program

PROG: 01      STEP: 01

Memory	M001	Off-Time:	Off
Run:	Skip	P/F-Time:	Off
On-Time:	0.1	Short-Time:	Off

Program Off      Program settings      Recall Default      Program settings

Operation

1. Press **FUNC** > *Program*[F1].
  - Note that *Program*[F1] is off by default.
2. Select *PROG* and select a program number to edit.

---

PROG      01 - 16

---

3. Select a *STEP* in the selected program.

---

STEP      01 - 16

---

4. Select *Memory* and select which memory

---

location to load for the selected step.

- Settings loaded from the memory location will be used for the selected step.
  - The same memory location can be used for multiple steps.
- 

Memory      M001 - M256

---

5. Set the *Run* setting for the step.

- By default RUN is set to Skip.
  - The Auto setting will automatically start and go onto the next step.
  - The Manual setting will wait for the user to press *Next[F2]* before running the step.
- 

Run            Skip, Auto, Manual

---

6. Choose the *On-Time* in seconds.

- The on-time setting determines how long the load is turned on for the selected step.
  - The on-time is defined as the total test time minus the off-time.
- 

On-Time      0.1 - 60 seconds

---

7. Choose the *Off-Time* in seconds.

- The off-time setting determines how long the load is turned off between the end of the current step and the start of the next step.
  - The off-time is defined as the total test time minus the on-time.
- 

Off-Time      Off, 0.1 - 60 seconds

---

8. Choose the *P/F-Time* (pass/fail time) in seconds.

- The P/F-Time refers to the P/F delay time. This delay time includes the 0.06 P/F start test time, as shown in the timing diagram on page 124.
- 

P/F-Time      Off, 0.0 - 119.9 seconds

---



9. Set the *Short-Time* in seconds.
    - Has the same action as pressing the short key.  
See page 64 for details about shorting the load.
- 

Short-Time      Off, 0.1 seconds - On-Time

---

10. Repeat steps 3 to 9 for all the steps in the program.
    - A maximum of 16 steps per program can be created.
    - Steps that are not configured are set to “Skip” by default.
  11. Press *Save[F3]* to save the program and all the steps in the program.
    - The program will be saved to internal memory.
    - See the Save/Recall chapter on details on how to save to Setup memory.
- 

- Recall Default
12. Pressing *Recall Default[F4]* will recall the default settings for each program/step. See page 252 for details.

## Create a Program Chain



Note

Before creating a program chain, make sure a number of programs have already been saved. These will be used to create the program chain.

Chain Setting  
Display Overview

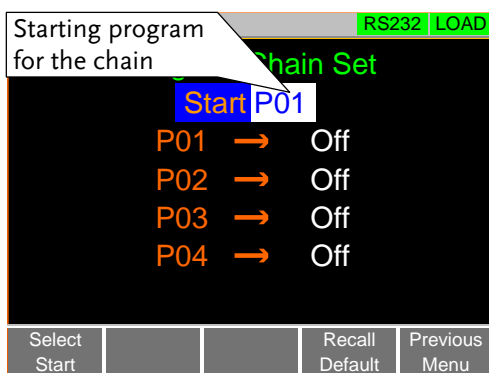

### Operation

1. Press **FUNC** > *Program*[F1] > *Chain*[F2].
  - It may be necessary to load the programs from Setup memory if they were not created in the current session.
2. If *Start* is not selected yet, press *Select Start*[F1] and select which program will be used to start the program chain.

Start: P01 - P16

3. Select *P01* and choose which program will be linked to *P01*.
  - Selecting OFF will end the chain after *P01*.
  - Selecting *P01* will create an infinite chain.
  - Chains need not be linked in sequential order.

P01: OFF, P01 - P16

4. Repeat step 3 for any remaining programs in the chain.

5. Press *Save* to save the program chain to internal memory.
6. Pressing *Recall Default*[F4] will reset the chain to the default settings. See page 252 for details.
  - Recall Default[F4] will essentially clear the program chain.

## Running a Program or Chain

---

**Description** A program or program chain is run the same way as a normal load.

---

**Operation**

1. Press  > *Program*[F1].
2. Turn program mode on by setting *Program*[F1] to On.
  - **PROG** will appear at the top of the display when *Program* is On.
3. Turn the load on.
  - The program/chain starts immediately.
  - The **PROG** icon turns orange when the load is turned on.
4. When a program/chain is running the screen displays which program, step and memory is currently active.
  - Press *Pause*[F1] to suspend a test, press *Continue*[F1] to resume.
  - Press *Next*[F2] to run the next step if its *Run* setting was set to *Manual*.
5. When a program/chain has finished running, a list of the Go-NoGo results for each step are displayed.
  - Press *Exit*[F5] to exit.

Display:  
Program/Chain  
Running

01/May/2021 RS232 PROG

**0.000V**    **0.00W**

**0.0000A**

Run Program

Program No: 01

Step(Memory) 01(001) GO

Conti

Step that is currently running.

Program number that is currently running.

Go-NoGo result for the step

Memory number of current step.

Display:  
Program/Chain  
Finished

01/May/2021 RS232 PROG

Run Program Detail Result

Program	Step	Result
1	1	GO
1	2	GO
1	3	NG

Exit

## Sequence

The PEL-3000A/AH supports both programs and sequences. The essential difference between programs and sequences is that programs can use different operating modes for each step while sequences use the same operating mode throughout the whole sequence. In effect sequences are used to create complex load simulations.

There are two different types of Sequences, Normal Sequences and Fast Sequences.

Normal sequences can define the execution time and slew rate of each step.

On the other hand the execution time for each step in a fast sequence is fixed to the rate (Time Base setting) set by the user.

### Normal Sequence Overview

---

Description	<p>A normal sequence is comprised of a user-defined number of steps that when executed in sequence can be used to simulate a DC load.</p> <ul style="list-style-type: none"><li>• Up to 1000* discrete steps can be configured using normal sequences.</li><li>• Each normal sequence can have a memo note attached to it.</li><li>• Normal Sequences can be looped up to 9999 discrete times or for an infinite amount of times.</li><li>• Normal sequences can be configured to hold a set voltage, current, power or resistance at the end of the load.</li><li>• Normal Sequences can be linked together in a chain.</li></ul>
-------------	--

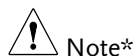

Up to 2560 discrete steps can be configured if software version is 2.41 or above.

---

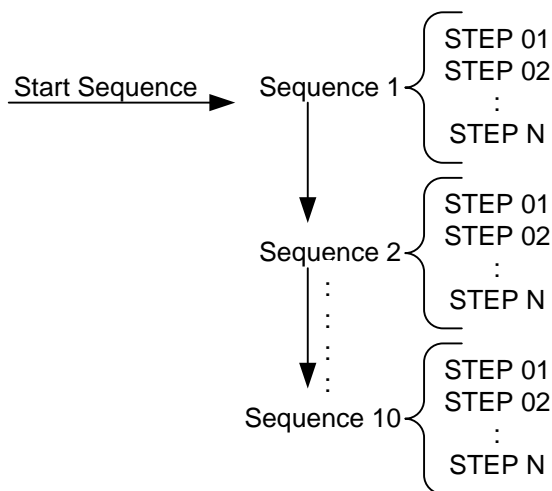

---

**Description**

Normal Sequence configuration is split into Timing Edit configuration and Data Edit configuration.

Timing Edit configuration is used to configure the actual sequences, such as mode, range, loops and chains.

Data Edit configuration is used to create the actual steps used in each sequence.

See below for a description of each.

---

**Timing Edit Overview**

A Normal Sequence contains the following timing settings for each sequence:

Setting	Setting Range	Description
Start	S01 - S10	Sets which sequence is used to start a chain of Normal Sequences.
Seq.No	S01 - S10	Sets the current sequence to edit.

Memo	12 characters	A user-created note for the currently selected sequence.
Mode	CC, CR, CV, CP	Operating mode for the sequence. +CV mode is supported.
Range	ILVL	Low I range, low V range
	IMVL	Middle I range, low V range
	IHVL	High I range, low V range
	ILVH	Low I range, high V range
	IMVH	Middle I range, high V range
	IHVH	High I range, high V range
Loop	Infinite, 01 - 9999	Sets the amount of times to loop the selected sequence.
Last Load	OFF, ON	Set the load condition after the end of the sequence.
Last	Value	The setting value of the load for when Last Load = ON.
Chain	Off, S01-S10	Sets the next sequence in the chain, when not set to off.

Data Edit Overview Each step in a normal sequence contains the following setting parameters:

Setting	Setting Range	Description
Step	0001 - 1000	<p>Selects/displays the current step in the sequence.</p> <ul style="list-style-type: none"> <li>The number of available steps is dependent on the number of steps added using the <i>Insert Point[F1]</i> functions.</li> </ul>

Value		The current, voltage, power or resistance setting for the selected operating mode.
Time	0.05ms - 999h:59m	Sets the step time for the selected step.
Load	ON, OFF	Turns the load on or off for the selected step.
RAMP	ON, OFF	When turned on the current transition is evenly ramped from the start of the step to the end of the step. When turned off the current transition is stepped.

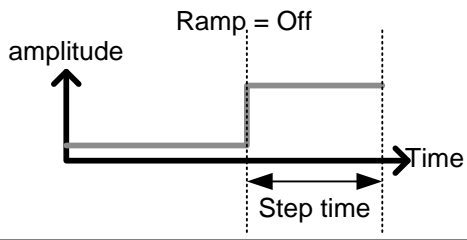
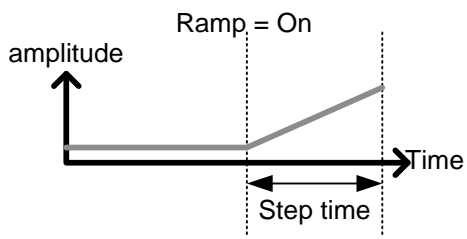

TRIG OUT	ON, OFF	When TRIG OUT is set to ON, a trigger signal is output from the TRIG OUT BNC terminal at the start of the step. See page 205 for details.
----------	---------	---



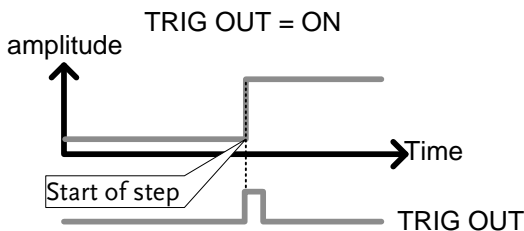

PAUSE	ON, OFF	<p>Pause: Inserts a pause at the end of the step. When paused, the unit will pause at the end of the step</p> <p>current/voltage/resistance/power level. The sequence can be resumed by pressing <i>Next</i>[F2] or by using an external trigger signal (page 203).</p>
-------	---------	---

### Timing Edit Configuration

Edit Timing Display

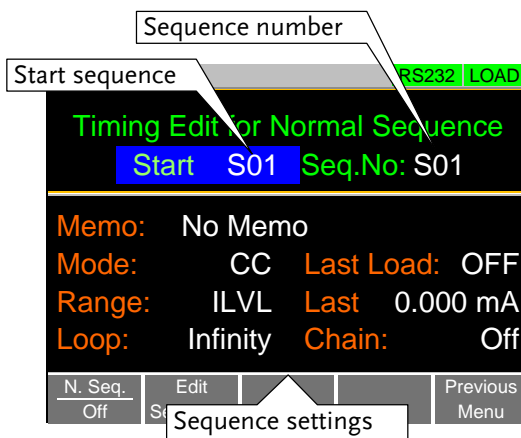

Operation

1. Press **FUNC** > *Normal Sequence*[F2].
  - Note that *N. Seq.*[F1] is off by default.
2. Select *Start* and select the number of the starting sequence.

---

Start: S01 - S10

---

3. Select a *Seq. No.* and select which sequence to edit.
- 

Seq. No.: S01 - S10

---

4. Set the following parameters for the currently selected sequence. See page 131 for details on each parameter.
  - Memo
  - Mode
  - Range
  - Loop
  - Last Load
  - Last
  - Chain
5. Press *Save[F3]* to save the timing settings for the currently selected sequence.

Sequence Timing configuration is complete.

- Go to Data Edit to edit the steps used in the Normal Sequences. See page 137.
- Go to Running a Normal Sequence to run the normal sequence. See page 138.

## Data Edit Configuration

## Data Edit Display

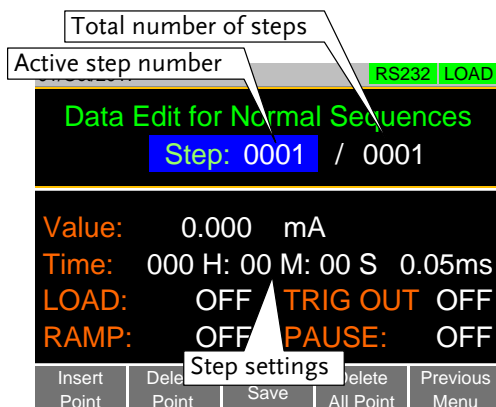

## Operation

1. Press **FUNC** > *Normal Sequence*[F2] > *Edit Sequence*[F2].
2. Select *Seq.No.* and select the sequence you wish to edit.

Start: S01 - S10

3. Press *Edit Sequence* [F2] to enter the Data Edit configuration menu.
  - Note that when there no steps in the current sequence the Data Edit for Normal Sequence settings are blank.
4. Press *Insert Point*[F1] to add a step to the sequence after the current step.
  - Every time *Insert Point* is pressed the *Step* parameter is incremented.
  - The inserted point becomes the current step.
5. Set the following parameters for the currently selected step. See the Data Edit Overview on page 133 for configuration details.

- Value
  - Time
  - LOAD
  - RAMP
  - TRIG OUT
  - PAUSE
6. If you wish to edit a previously inserted point/step, use the *Step* parameter.
- Steps can only be selected after they have already been inserted.

---

Steps                    0001 - 1000

---

7. The currently selected step can be deleted using the *Delete Point[F2]* function.
8. After all the steps for the sequence are complete, press *Save[F3]* to save the steps.

Data Edit for Normal Sequence configuration is complete.

- Go to Timing Edit for Normal Sequences to edit the sequence. Page 135.
  - Go to Running a Normal Sequence to run the normal sequence. Page 138.
- 

## Running a Normal Sequence

---

**Description**                    Unlike a normal static or dynamic load, a load created with the Normal Sequence function is turned on by pressing the Shift and Load keys.

---

- Operation**
1. Press **FUNC** > *Normal Sequence[F2]*.
  2. Turn normal sequence mode on by setting *N. Seq.[F1]* to *On*.
- **NSEQ** will appear at the top of the display when
-



---

N. Seq. is On.

- The Normal Sequence function can also be turned on from the FUNC menu. See page 117 for details.

3. Turn the load on by pressing



- The  key will turn orange when the load is "on".
  - The load can be turned off again by pressing the  key.
  - The normal sequence/chain starts immediately.
  - The **NSEQ** icon turns orange when the load is turned on.
4. When a normal sequence/chain is running, the screen displays which sequence, step and loop are currently active. It also displays the elapsed or remaining test time and elapsed/remaining time of the current step.
- Sequences can be paused by pressing Pause [F1] and resumed again by pressing Continue [F1].
  - If no steps have been created "No N.Seq." will be displayed on the screen.
  - "Sequence Complete" will be displayed at the end of the sequence.
-

Display:  
Sequence/Chain  
Running

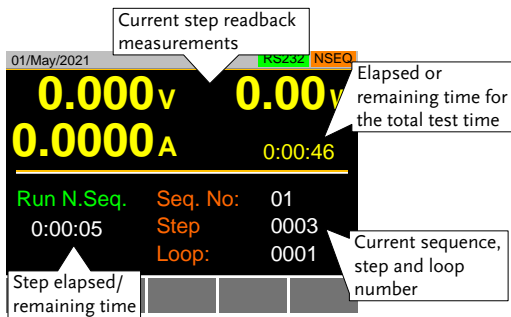

Note

The combined test time for all sequences will be displayed as *elapsed test time* if the elapsed time is >1000 hours, else the *remaining test time* will be displayed.

## Fast Sequence Overview

---

- Description
- A fast sequence is comprised of a user-defined number of steps that can be executed at a high frequency. Unlike normal sequences, each step in a fast sequence has the same execution time (time base).
- This mode is only available for CC and CR mode.
  - Up to 1000 discrete steps can be configured using fast sequences.
  - Each fast sequence can have a memo note attached to it.
  - Fast Sequences can be looped up to 9999 discrete times or for an infinite amount of times.
  - Fast sequences can be configured to hold a set current or resistance at the end of the load.
  - No ramping function can be used with the Fast Sequence function.

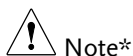
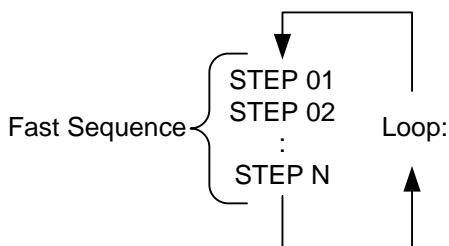

Note\*

Up to 2560 discrete steps can be configured if software version is 2.41 or above.

---

Fast Sequence configuration is split into Timing Edit configuration and Data Edit configuration.

Timing Edit configuration is used to configure all the settings that are common to all the steps of the fast sequence. This includes settings such as the mode, range, loops and time base.

Data Edit configuration is used to create the actual steps used in each sequence.

See below for a description of each.

**Timing Edit Overview**

A Fast Sequence contains the following timing settings for each sequence:

Setting	Setting Range	Description
Memo	12 characters	A user-created note for the currently selected sequence.
Mode	CC, CR	Operating mode for the sequence.
Range	ILVL	Low I range, low V range
	IMVL	Middle I range, low V range
	IHVL	High I range, low V range
	ILVH	Low I range, high V range
	IMVH	Middle I range, high V range
	IHVH	High I range, high V range
Loop	Infinity, 01 - 9999	Sets the amount of times to loop the selected sequence.
Last Load	OFF, ON	Set the load condition after the end of the sequence.
Last	0.000000	The load setting for when Last Load is set to ON.



RPTSTEP	0001 - 1000	Last step number (0001-1000) per loop
Time Base	0.025 - 600ms	Sets the step execution time.
Data Edit Overview	Each step in a fast sequence contains the following setting parameters:	

Setting	Setting Range	Description
Step	0001 - 1000	<p>Selects/displays the current step in the sequence.</p> <ul style="list-style-type: none"> <li>The number of available steps is dependent on the number of steps added using the <i>Ins. Point[F1]</i> functions.</li> <li>A minimum of 3 steps.</li> </ul>
Value		The current or resistance setting for the selected operating mode.
TRIG OUT	ON, OFF	When TRIG OUT is set to ON, a trigger signal is output from the TRIG OUT BNC terminal at the start of the step. See page 205 for details.

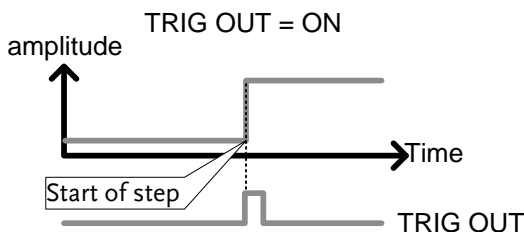

FILL Overview	<p>The FILL function is used to evenly step up the current or resistance value settings from a starting step to a finishing step.</p> <p>The Fill Function can be used before or after points</p>
---------------	---

are added to the fast sequence.

- Before: Will pre-fill each value within the fill range when a new step is added.
- After: Will post-fill each value within the fill range.

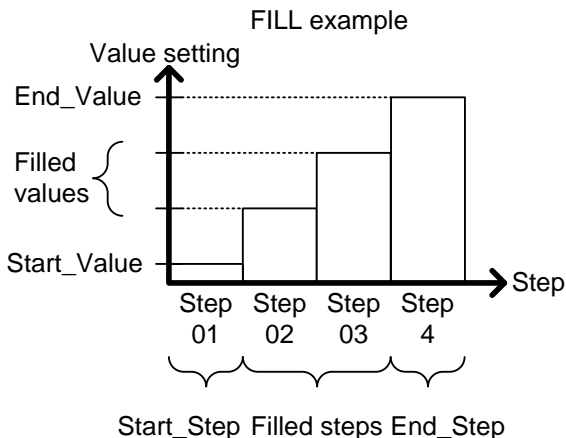

Setting	Setting Range	Description
Start_Value		Sets the current or resistance value for the starting step.
End_Value		Sets the current or resistance value for the ending step.
Start_Step	0001 - 1000	Sets the starting step number.
End_Step	0001 - 1000	Sets the ending step number.

## Timing Edit Configuration

Edit Timing  
Display

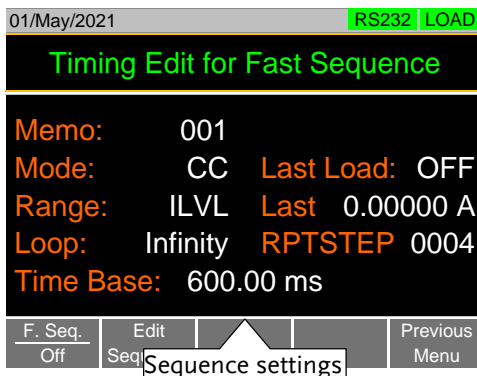

Operation

1. Press **FUNC** > *Fast Sequence*[F3].
  - Note that *F. Seq.*[F1] is off by default.
2. Set the following parameters for the fast sequence. See page 140 for details on each parameter.
  - Memo
  - Mode
  - Range
  - Loop
  - Time Base
  - Last Load
  - Last
  - RPTSTEP

Save

3. Press *Save*[F3] to save the timing settings for the fast sequence.

Sequence Timing configuration is complete.

- Go to Data Edit to edit the steps used in the Fast Sequence. Page 146.
- Go to Running a Fast Sequence to run the fast sequence. Page 148.

### Data Edit Configuration

#### Data Edit Display

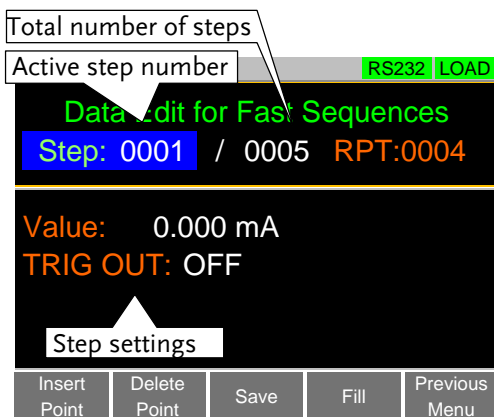

#### FILL Display

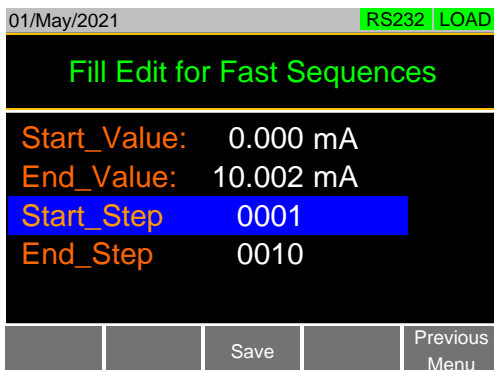

#### Operation

1. Press **FUNC** > *Fast Sequence[F3]* > *Edit Sequence[F2]* to enter the Data Edit configuration menu.
2. Press *Insert Point[F1]* to add a step to the

sequence.

- Every-time *Insert Point* is pressed the *Step* parameter is incremented.
  - The newly inserted “point” becomes the active step.
3. Set the following parameters for the currently selected step. See page 140 for configuration details.
    - Value
    - TRIG OUT
  4. If you wish to edit a previously added point/step, use the *Steps* parameter.
    - Steps can only be selected after they have already been added.

---

Steps                    0001 - 1000(RPTSTEP)

---

5. The currently selected step can be deleted using the *Delete Point[F2]* function.
  - There cannot be less than 3 steps for fast sequences.

---

Fill Function

6. Press *FILL[F4]* to use the fill function. Set the fill parameters:
  - Start\_Value
  - End\_Value
  - Start\_Step
  - End\_Step

The fill function can be used any number of times.

---

Save

7. After all the steps for the sequence are complete, press *Save[F3]* to save the steps.

Data Edit for Fast Sequences configuration is complete.

- Go to Timing Edit for Fast Sequences to edit the sequence. Page 145.
-

- Go to Running a Fast Sequence to run the fast sequence. Page 148.
- 





## Running a Fast Sequence

---

**Description** Unlike a normal static or dynamic load, a Fast Sequence load is turned on by pressing the Shift and Load keys.

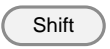
---

**Operation**

1. Press  > *Fast Sequence*[F3].
  2. Turn fast sequence mode on by setting *F. Seq.*[F1] to *On*.
    - **FSEQ** will appear at the top of the display when *F. Seq.* is *On*.
  3. Turn the load on by pressing  
 + .
    - The  key will turn orange when the load is “on”.
    - The load can be turned off again by pressing the  key.
    - The fast sequence/chain starts immediately.
    - The **FSEQ** icon turns orange when the load is turned on.
  4. When a fast sequence is running, the screen displays which step and loop is currently active.
    - “*Sequence Complete*” will be shown on the display at the end of the sequence.
-

Display:  
Fast Sequence  
Running

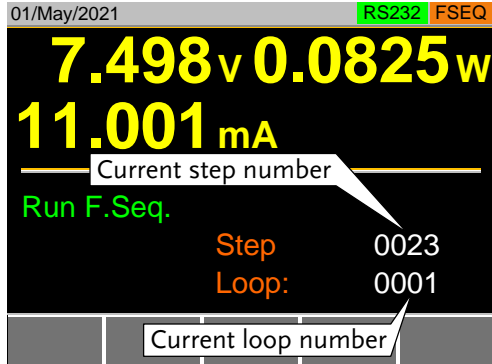

## OCP Test Automation

**Background** The OCP test function creates an automatic test to test the OCP of power supply products.

This test will test to see when the over current protection of a power supply is tripped and return the measurements for the voltage and current when the over current protection was tripped. The PEL-3000A/AH also has a user-defined cutoff setting in the event that the power supply OCP fails.

The diagram below shows an example of the OCP Test Automation function:

**Example** The test current increases from a starting value (Start C) to an end value (End C). The current increases in steps (set by Step\_C) with a set step time (set by Step\_T) until the power supply's OCP is tripped or the End C current level is reached.

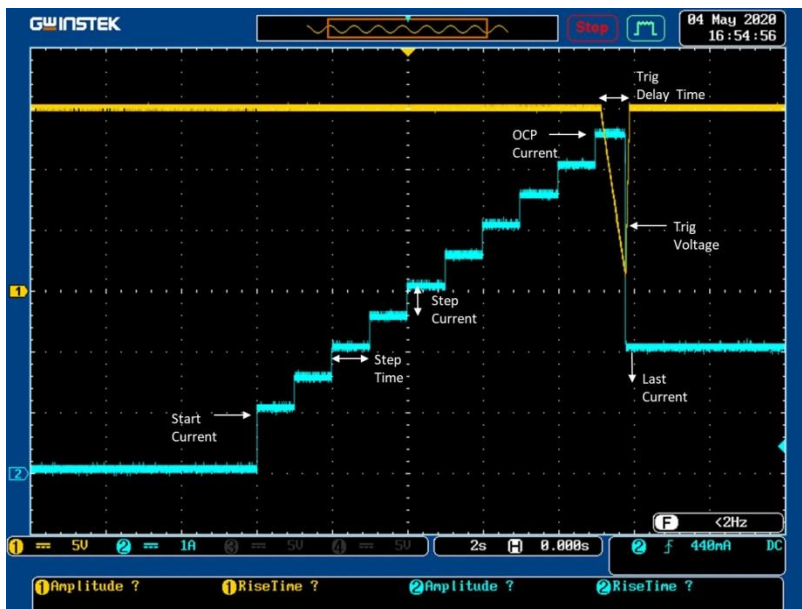



---

Parameters	OCP. No	Selects one of 12 OCP test setup memories.
	Memo	A user-created note for the currently selected OCP function.
	Range	High(CC Mode High), Middle(CC Mode Middle) and Low(CC Mode Low)
	Start Current (Start C)	Starting current value for the test.
	End Current (End C)	The current value that will end the test. The value must be higher than the OCP value of the DUT you are testing. This parameter is used as a fail-safe for if the over current protection of the DUT fails. If the measured current reaches End Current value it would then indicate that the power supply OCP failed.
	Step Current (Step_C)	Sets the step resolution of the current.
	Step Time (Step_T)	Sets the execution time of each step. (50ms ~ 1600s)
	Trig Delay Time (Delay)	Sets a delay corresponding to the time a Trig Voltage can be expected after each step Current is applied (the delay time must be less than the Step time). (0ms ~ 160s)

<p>Trig Voltage (Trig_V)</p>	<p>Sets the trigger to a level needed to see when the power supply OCP has been triggered.</p> <p>When the power supply OCP has been triggered, its voltage output will reset. The voltage trigger level is used to test to see if the voltage output has been reset.</p>
<p>Last Current (Last_C)</p>	<p>Sets the final current value after OCP has been tripped. This is the steady-state current draw after the OCP has been tripped.</p>



Note

This mode can only be used under CC mode.

Panel operation

1. Press  > OCP[F4].



Select Channel

2. Select OCP. No: and select a test setup memory.

OCP. No: 1 ~ 12

3. Set the following parameters for the selected test setup above:

- Memo
- Range
- Start C

- End\_C
- Step\_C
- Step\_T
- Delay
- Trig\_V
- Last\_C

4. Press the *Save[F3]* to save the selected test setup.

Start OCP

5. Press *OCP[F1]* to turn the OCP function on if it is off.
6. The OCP function can be started by turning the load on by pressing **Shift** + **Load<sup>On/Off</sup>**.
  - The test current will increase from the Start C value to the End C value in steps according to the Step C value, until the test has finished.
  - The test will start running when the power supply voltage is greater than the Trig V voltage.

Example: OCP Function running

Measured voltage, current and power

RS232 OCP

**7.498V**      **1.15W**  
**0.1531A**

---

OCP Test      Set Curr:      Fetch Volt:  
 Running.      2.000      6.91  
                   1.500      6.92  
                   0.000      6.91

Set current for the last three steps (descending order)

Measured voltage for last three steps

Results:

Power Source  
OCP tripped

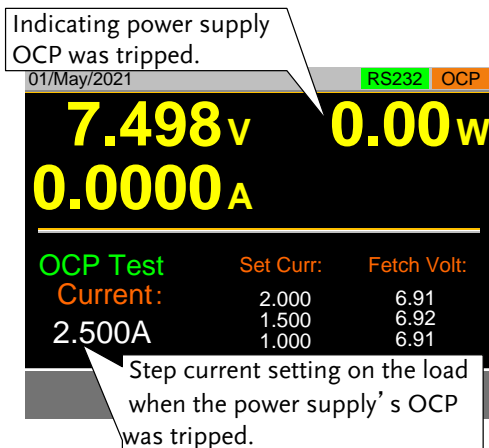

The OCP Test will return the current setting of the last step when the power supply's OCP was tripped.

Power Source  
OCP time out

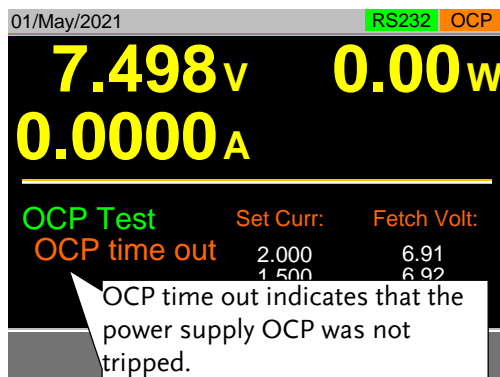

OCP time out will occur if the power supply's OCP fails to trigger. This is determined when the measured voltage is never less than Trig V and the measured current is greater than End C.

Power Source  
Config Error

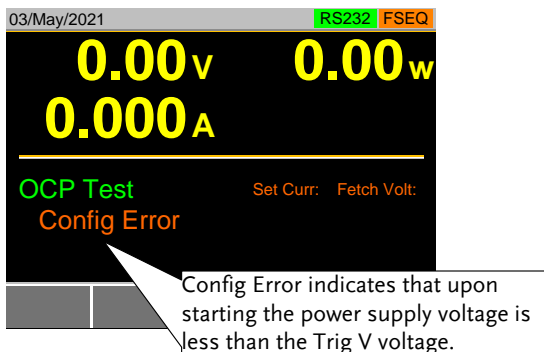

Config Error indicates that the power supply voltage is less than the Trig V voltage setting after the test has started. This can indicate that the power supply output is not on or that the power supply output or Trig V is incorrectly configured.



Note

In addition to the OCP settings as described above, the Trig voltage settings must also be set according to the output characteristics of the DUT.

Save Data

When the Power Source OCP was tripped. Press TEST Result [F1] to view the test result waveform.

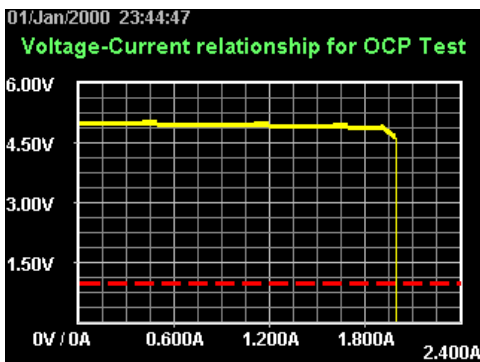

Plug in USB flash drive and press Save [F3] to save the waveform picture.  
Press Esc [F1] to exit the waveform view mode.

Press Save [F3] to save the data log to USB flash drive. The file name should be RESULTxx.CSV. The file RESULTxx.CSV can be opened in the computer. The maximum amount of data to be recorded in the data log is 65536. If data exceeds this limit, the extra data won't be recorded.

	A	B	C	D	E	F
1	<< OCP TEST >>			PEL-3021A v1.32		
2	< PARAMETER of OCP TEST >					
3	OCP No.:		1			
4	(1) Memo:					
5	(2) Range:	Middle				
6	(3) Start Curr:	0.001 A				
7	(4) End Curr:	3.000 A				
8	(5) Step Curr:	0.100 A				
9	(6) Step Time:	0.05 s				
10	(7) Delay Time:	0.00 s				
11	(8) Trig Volt:	1.00 V				
12						
13	< TEST RESULTS >					
14	Start Time:	2000/1/1 23:44				
15	End Time:	2000/1/1 23:44				
16	(1) Test Result:	Complete		OCP :	2.001 A	
17						
18	(2) DATA LISITS(22):					
19	Step No	VOLT(V)	CURR(A)	POWER(W)		
20		0	4.98	0.011	0.05478	
21		1	4.98	0.01	0.0498	
22		2	4.98	0.103	0.51294	
23		3	4.97	0.202	1.00394	
24		4	4.96	0.303	1.50288	
25		5	4.96	0.403	1.99888	

# OPP Test Automation

**Background**      The OPP test function creates an automatic test to test the OPP of power supply products.

This test will test to see when the over power protection of a power supply is tripped and return the measurements for the voltage and current when the over power protection was tripped. The PEL-3000A/AH also has a user-defined cutoff setting in the event that the power supply OPP fails.

The diagram below shows an example of the OPP Test Automation function:

**Example**          The test watt increases from a starting value (Start W) to an end value (End W). The watt increases in steps (set by Step\_W) with a set step time (set by Step\_T) until the power supply's OPP is tripped or the End W watt level is reached.

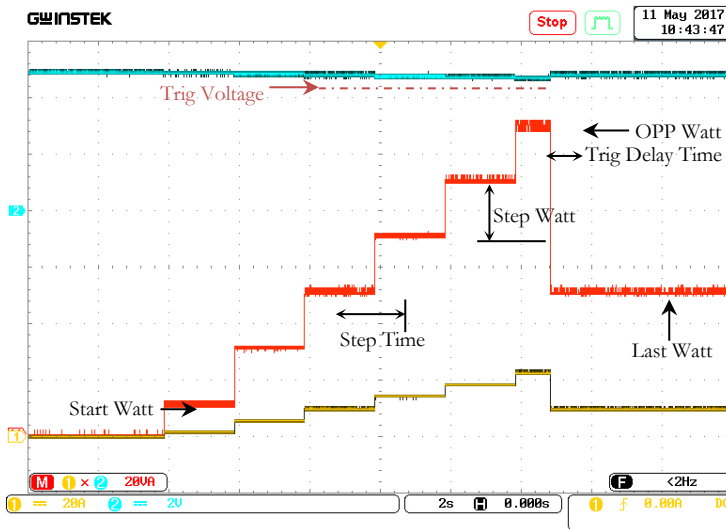

**Parameters**      **OPP. No**      Selects one of 12 OPP test setup memories.

---

Memo	A user-created note for the currently selected OPP function.
Range	High(CP Mode High) Middle(CP Mode Middle) Low(CP Mode Low)
Start Watt (Start W)	Starting watt value for the test.
End Watt (End W)	The watt value that will end the test. The value must be higher than the OPP value of the DUT you are testing. This parameter is used as a fail-safe for if the over power protection of the DUT fails. If the measured watt is reaches End Watt value it would then indicate that the power supply OPP failed.
Step Watt (Step W)	Sets the step resolution of the watt.
Step Time (Step T)	Sets the execution time of each step. (50ms ~ 1600s)
Trig Delay Time (Delay)	Sets a delay corresponding to the time a Trig Voltage can be expected after each step Watt is applied (the delay time must be less than the Step time)(0ms~ 160s).
Trig Voltage (Trig V)	Sets the trigger to a level needed to see when the power supply OPP has been triggered. When the power supply OPP has been triggered, its voltage output will reset. The voltage trigger level is used to test to see if the voltage output has been reset.



Last Watt (Last W) Sets the final watt value after OPP has been tripped. This is the steady-state watt draw after the OPP has been tripped.

Panel operation

1. Press  > Next Menu[F5]. > OPP[F1].

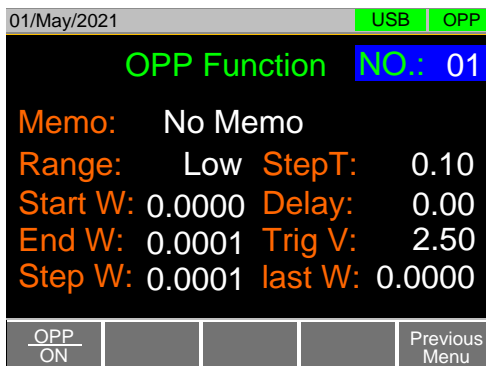

Select Channel

2. Select *OPP, No:* and select a test setup memory.

OPP. No: 1 ~ 12

3. Set the following parameters for the selected test setup above:
- Memo
  - Range
  - Start W
  - End W
  - Step W
  - Step T
  - Delay
  - Trig V
  - Last W
4. Press the *Save[F3]* to save the selected test setup.

Start OPP

5. Press *OPP[F1]* to turn the OPP function on if it is off.
6. The OPP function can be started by turning the load on by pressing



- The test watt will increase from the Start W value to the End W value in steps according to the Step W value, until the test has finished.
- The test will start running when the power supply voltage is greater than the Trig V voltage.

Example: OPP  
Function running

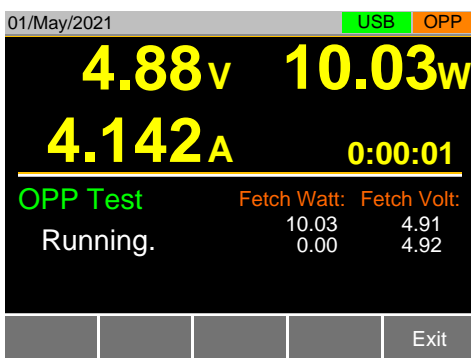

Results:

Power Source  
OPP tripped

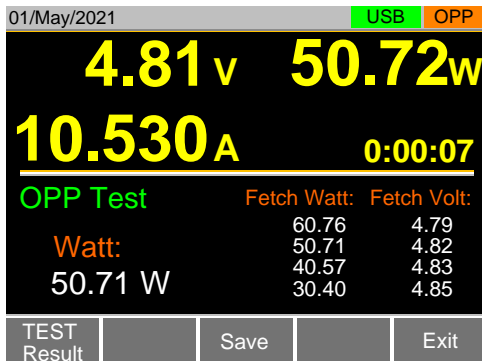

The OPP Test will return the current setting of the last step when the power supply's OPP was tripped.

Power Source  
OPP time out

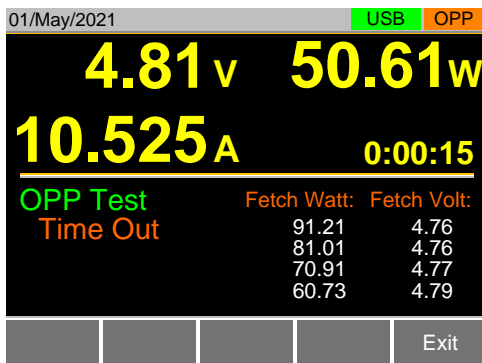

OPP time out will occur if the power supply's OPP fails to trigger. This is determined when the measured voltage is never less than Trig V and the measured watt is greater than End W.

Power Source  
Config Error

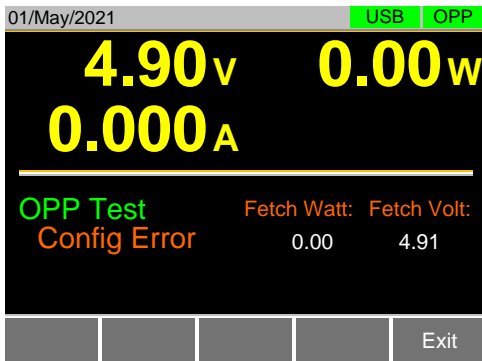

Config Error indicates that the power supply voltage is less than the Trig V voltage setting after the test has started. This can indicate that the power supply output is not on or that the power supply output or Trig V is incorrectly configured.



Note

In addition to the OPP settings as described above, the Trig voltage settings must also be set according to the output characteristics of the DUT.

Save Data

When the Power Source OPP was tripped. Press TEST Result [F1] to view the test result waveform.

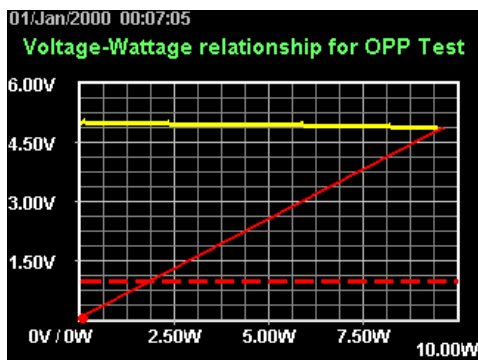

Plug in USB flash drive and press Save [F3] to save the waveform picture.

Press Esc [F1] to exit the waveform view mode.

Press Save [F3] to save the data log to USB flash drive. The file name should be RESULTxx.CSV. The file RESULTxx.CSV can be opened in the computer.

The maximum amount of data to be recorded in the data log is 65536. If data exceeds this limit, the extra data won't be recorded.

	A	B	C	D	E	F
1	<< OPP TEST >>			PEL-3021A v1.32		
2	< PARAMETER of OPP TEST >					
3	OPP No.:		1			
4	(1) Memo:					
5	(2) Range:	Middle				
6	(3) Start Watt:	0.01000 W				
7	(4) End Watt:	15.00000 W				
8	(5) Step Watt:	0.10000 W				
9	(6) Step Time:	0.10 s				
10	(7) Delay Time:	0.00 s				
11	(8) Trig Volt:	1.00 V				
12						
13	< TEST RESULTS >					
14	Start Time:		2000/1/1 00:07			
15	End Time:		2000/1/1 00:07			
16	(1) Test Result:	Complete		OPP :	9.6612 W	
17						
18	(2) DATA LISITS(101):					
19	StepNo	VOLT(V)	CURR(A)	POWER(W)		
20	0	4.98	0.01	0.0498		
21	1	4.98	0.01	0.0498		
22	2	4.98	0.01	0.0498		
23	3	4.98	0.01	0.0498		
24	4	4.98	0.01	0.0498		
25	5	4.99	0.019	0.09481		

## BATT Test Automation

**Background** The BATT test function creates an automatic test to test the discharge of Battery products.

The test will discharge in a fixed mode (CC, CR, CP) and will end after a defined stop point (stop voltage, stop time, stop AH) has been detected. The information about discharge test (discharge time, battery AH, battery WH) can be finally seen on the panel (discharge time display must enable the count time function. See page 78 the paragraph **Count time**).

The PEL-3000A/AH also has a user-defined cutoff setting in the event that the Battery test fails.

The diagram below shows an example of the BATT Test Automation function:

**Example** The test will run in the specified mode with defined values and will stop when the defined stop values are reached.

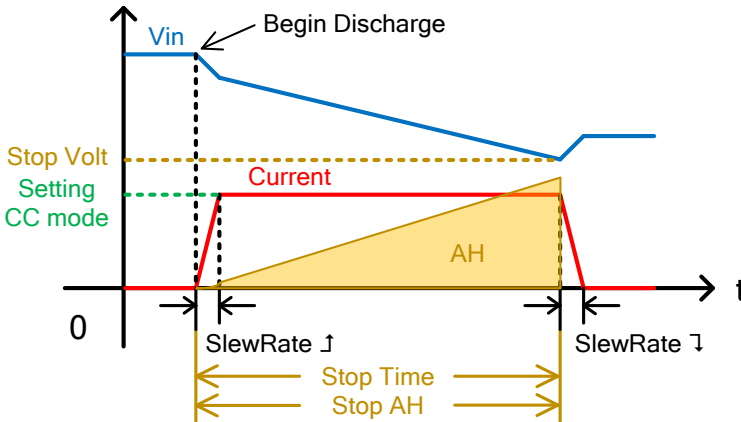

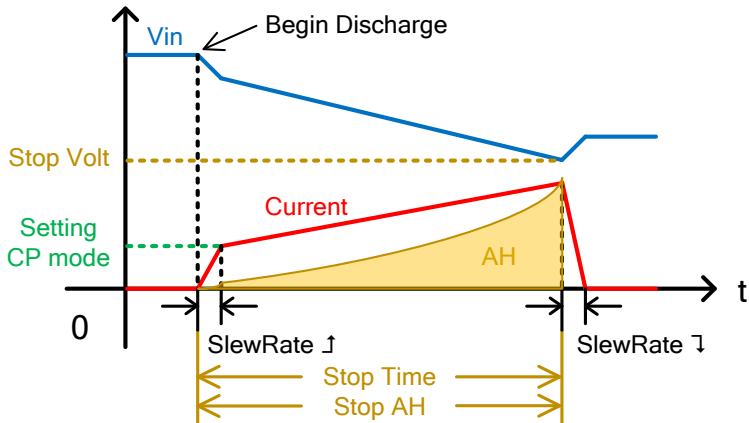
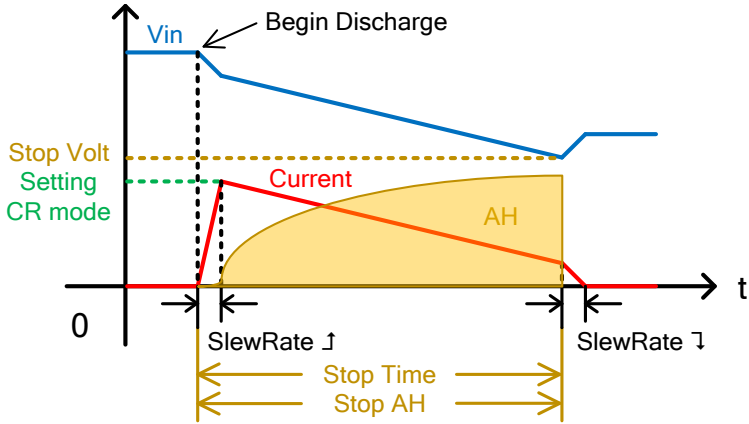

Parameters	BATT No.	Selects one of 12 BATT test setup memories.
	Memo	A user-created note for the currently selected BATT function.
	Mode	Select a discharge operation mode. (CC, CR, CP)
	Range	ILVL(I range low, V range low) IMVL(I range middle, V range low) IHVL(I range high, V range low)

	ILVH(I range low, V range high)
	IMVH(I range middle, V range high)
	IHVH(I range high, V range high)
Setting	Sets the values corresponding to the defined discharging mode (CC mode in A, CR mode in mS and CP mode in W).
SlewRate↑	Sets the test rising slew rate in mA/μs (not adjustable for CP mode).
SlewRate↓	Sets the test falling slew rate in mA/μs (not adjustable for CP mode).
Stop Volt	Sets the voltage at which the test should be interrupted. The value must be lower than the battery start voltage.
Stop Time	Sets the time after which the test should be interrupted (max value is 999h:59m:59s).
Stop AH	Sets the discharged energy rate at which the test should be interrupted (Max value is 9999.99Ah).
Datalog timer	Sets the time interval for data capture. Up to 65,535 data can be saved when running data logging function. When logging data reaches to the maximum amount, it won't be saved and be ignored.

---

#### Panel operation

1. Press  > Next Menu[F5]. > BATT[F2].



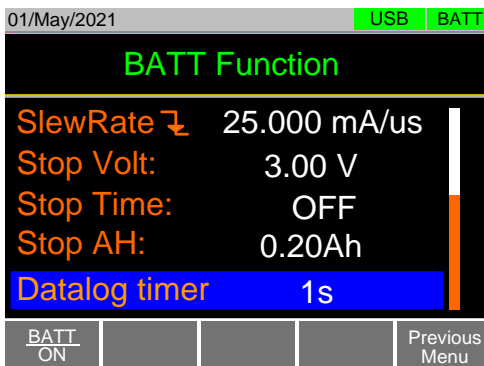
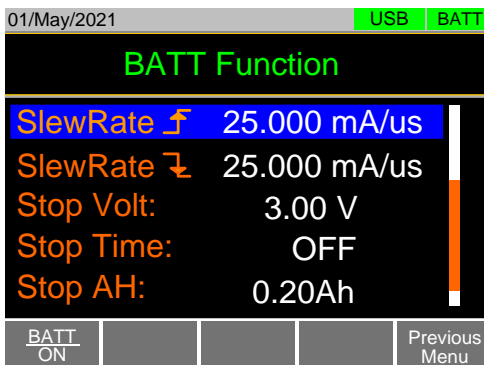
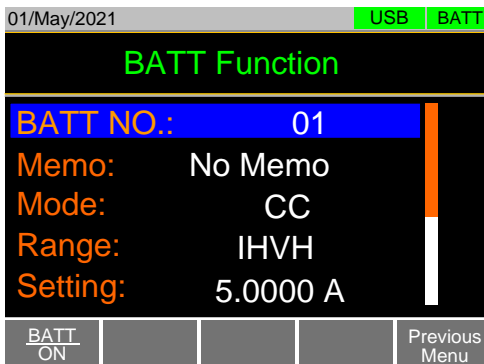

2. Set the following parameters for the selected test setup above:

- BATT No.
- Memo
- Mode
- Range
- Setting
- SlewRate↓
- SlewRate↑
- SlewRate↓
- Stop Volt
- Stop Time
- Stop AH
- Datalog timer
- 

3. Press the *Save*[F3] to save the selected test setup.

Start BATT

1. Press *BATT*[F1] to turn the BATT function on if it is off.
2. The BATT function can be started by turning the load on by pressing

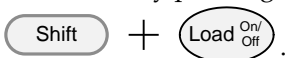

- The discharge test will keep running with its defined mode and values until any of the Stop Voltage, Stop Time or Stop AH settings is detected.

Save Data

When the Battery stop voltage, stop time or stop AH was tripped. Press TEST Result [F1] to view the test result waveform.

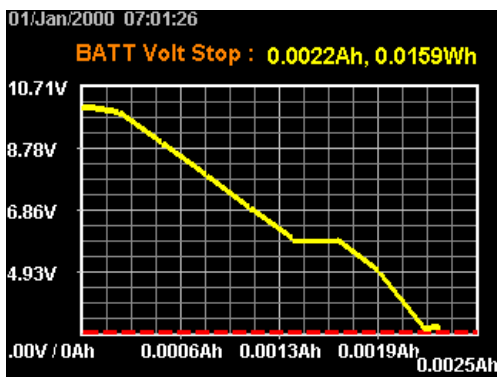

Plug in USB flash drive and press Save [F3] to

save the waveform picture.  
Press Esc [F1] to exit the waveform view mode.

Press Save [F3] to save the data log to USB flash drive. The file name should be RESULTxx.CSV. The file RESULTxx.CSV can be opened in the computer.

The maximum amount of data to be recorded in the data log is 65536. If data exceeds this limit, the extra data won't be recorded.

	A	B	C	D	E	F	G
1	<< BATT TEST >>			PEL-3XXXXA v1.31.003			
2	< PARAMETER of BATT TEST >						
3	BATT No.:		1				
4	(1) Memo:						
5	(2) Mode:		CC				
6	(3) Range:		IHVH				
7	(4) Set CC:		1.000 A				
8	(5) Stop Volt:		3.00 V				
9	(6) Stop Time:		0 h	0 m	10 s		
10	(7) Stop AH:		0.20 Ah				
11							
12	< TEST RESULTS >						
13	Start Time:		2000/1/1 07:01				
14	End Time:		2000/1/1 07:01				
15	(1) Test Length:		0 h	0 m	8 s		
16	(2) Recorder Length:		0 h	0 m	8 s		
17	(3) Stop Condition:		Under VOLT				
18	(2) DATA LISITS(9):		Timebase(sec):		1 s		
19	No	VOLT(V)	CURR(A)	POWER(WAH)	WH		
20		0	10.01	0.002	0.02002	0	0
21		1	9.84	0.998	9.82032	0.0002	0.0024
22		2	8.85	0.998	8.89218	0.0005	0.005
23		3	7.85	0.998	7.8343	0.0008	0.0074
24		4	6.85	0.998	6.84628	0.0011	0.0096
25		5	5.87	0.998	5.85826	0.0014	0.0115
26		6	5.85	0.998	5.8383	0.0016	0.0131
27		7	4.86	0.998	4.85028	0.0019	0.0145
28		8	2.86	0.998	2.85428	0.0022	0.0157
29							

Example: BATT  
Function running

01/May/2021
USB
BATT

4.90v    24.47w

4.994A    0:00:01

---

0.0024 Ah    0.0019 Wh

Discharging:  
CC, IHVH, 5.0000 A  
Stop: 3.00V, 0.20Ah

Exit

Results:  
 Battery stop  
 Voltage or stop  
 time or stop AH  
 tripped



The BATT Test will return the information of the last discharge when the Battery stop voltage or stop time or stop AH was tripped.



In addition to the BATT Function settings as described above, the Stop Volt voltage settings must also be set according to the output characteristics of the DUT.

## MPPT

Background	The MPPT (Maximum Power Point Tracking) function of PEL-3000A/AH series can perform IV, PV characteristics and Pmax tracking tests of solar panels.
Note	The firmware (Ver.1.32 or later for PEL-3000A and Ver.1.08 or later for PEL-3000AH series) is compatible with this extended function.
Features of this function	It is possible to test the IV and PV characteristics of solar panels.

I-V and P-V characteristic

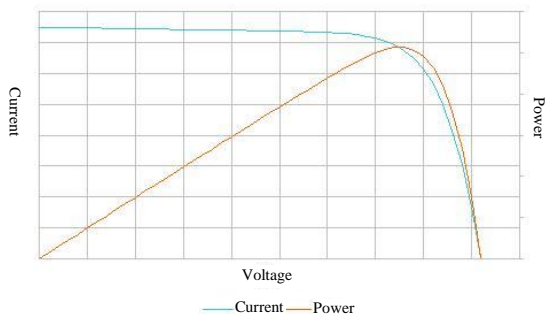

Furthermore, Pmax tracking test can be performed by turning on tracking.

MPPT

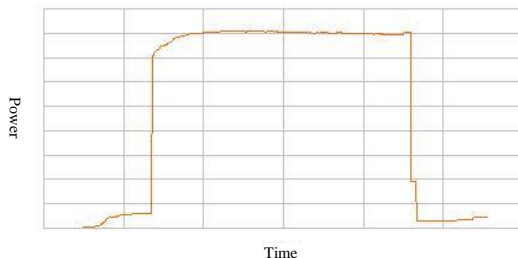

Test data is saved on USB memory. It supports USB memory up to 2GB.

Parameters	MPPT No.	Set one of 12 test patterns.
	Memo	A user-created note for the currently selected BATT function.
	Mode	Select a discharge operation mode. (CC, CV)
	Range	Set the voltage and current range. ILVL(I range low, V range low) IMVL(I range middle, V range low) IHVL(I range high, V range low) ILVH(I range low, V range high) IMVH(I range middle, V range high) IHVH(I range high, V range high)
	Response	Set the response speed of each discharge mode. CV mode: Slow, Fast CC mode: 1, 1/2, 1/5, 1/10
	Sweep Range	Set the conditions for the sweep range. CV mode: Value, Percent CC mode: Value only
	Start V (Start Voltage)	Response appears only in CV mode. Set the start voltage value and its range is from 0V to the maximum of the setting voltage.
	End V (End Voltage)	Response appears only in CV mode. Set the end voltage value and its range is from 0V to the maximum of the setting voltage.
	Step V (Step Voltage)	Response appears only in CV mode. Set the step voltage value and its range is from 0V to half of the maximum of the setting voltage.

- Start C (Start Current) Response appears only in CC mode. Set the start current value and its range is from 0A to the maximum of the setting current.
- End C (End Current) Response appears only in CC mode. Set the end current value and its range is from 0A to the maximum of the setting current.
- Step C (Step Current) Response appears only in CC mode. Set the step current value and its range is from 0A to half of the maximum of the setting current.
- Step Time Set the step time and its range is from 0.01s to 50s.
- Detect Short (Short Circuit Detection) "Disable" only.

Panel operation

1. Press **FUNC** > *Next Menu*[F5] > *MPPT*[F4].

When CV mode is set

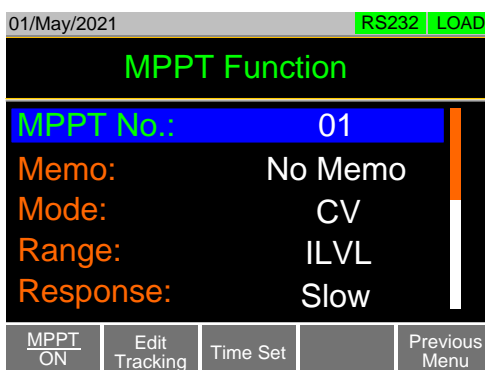



01/May/2021		RS232 LOAD	
<b>MPPT Function</b>			
<b>Sweep Range:</b>		<b>Value</b>	
Start V:	0.000 V		
End V:	0.000 V		
Step V:	0.000 V		
Step Time:	0.000 V		
<b>MPPT ON</b>	Edit Tracking	Time Set	Previous Menu

01/May/2021		RS232 LOAD	
<b>MPPT Function</b>			
Start V:	0.000 V		
End V:	0.000 V		
Step V:	0.001 V		
Step Time:	0.01 s		
<b>Detect Short:</b>	<b>Disable</b>		
<b>MPPT ON</b>	Edit Tracking	Time Set	Previous Menu

When CC mode is set

01/May/2021		RS232 LOAD	
<b>MPPT Function</b>			
<b>MPPT No.:</b>		<b>01</b>	
Memo:	2		
Mode:	CC		
Range:	ILVL		
Response:	1		
<b>MPPT ON</b>	Edit Tracking	Time Set	Previous Menu

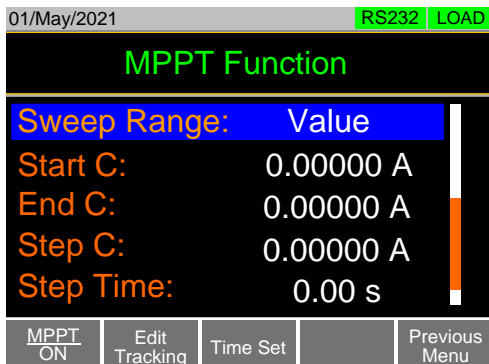

2. Set the following parameters.

- MPPT No.
- Mode
- Response
- Start C (Start V)
- Step C (Step V)
- Detect Short (Disable only)
- Memo
- Range
- Sweep Range
- End C (End V)
- Step Time

Edit Tracking of MPPT function

Background	Set tracking the maximum power point of MPPT function.	
Parameters	Tracking	Enable/ Disable tracking the maximum power point of MPPT function.
	Track Step	Set the tracking range (0.01% to 5.00%).
	Track Step Time	Set the tracking time (0.01s to 2.00 s).
	Pmax Detection	Set the detection time of Pmax (Pmax Detection (maximum power point) (OFF,

Time Interval) 1m to 60m). Redetecting can also be used when the maximum power point is two.

Measure Interval Set the measurement time (Measurement interval (1.0s to 60.0s).  
Time Interval)

Panel operation

1. Press **FUNC** > *Next Menu*[F5] > *MPPT*[F4] *Edit Tracking*[F2].

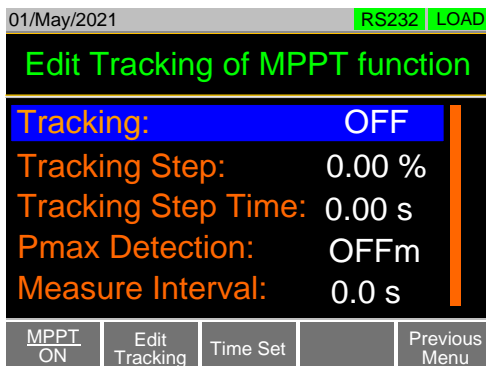

2. Set the following parameters.
  - Tracking
  - Track Step
  - Track Step Time
  - Pmax Detection
  - Measure Interval

Auto Load of MPPT function

Background	Set start date and stop date of MPPT test.	
Parameters	Auto Load on/off	Set the date and time of the test.
	Disable	Disable the Auto Load on/off
	Only Start	Set start date and time only.
	Only Stop	Set stop date and time only.

Enable                      Set the start and stop date, start and stop time.

Panel operation

1. Press **FUNC** > *Next Manu*[F5] > *MPPT*[F4] *Time Set*[F3].

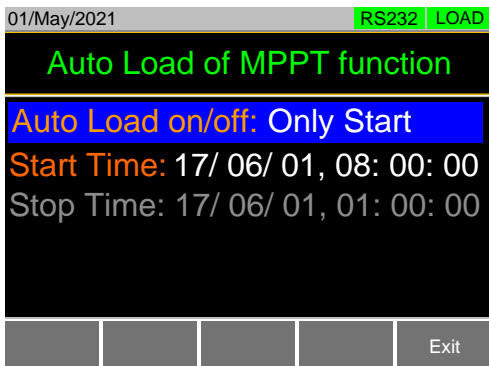
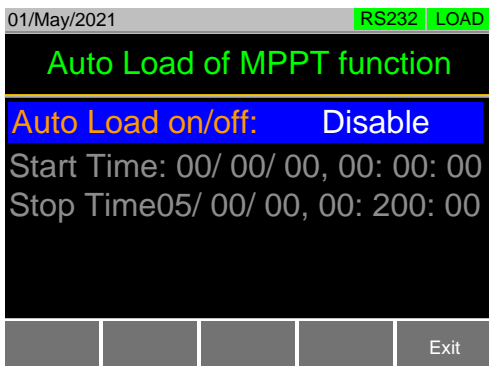

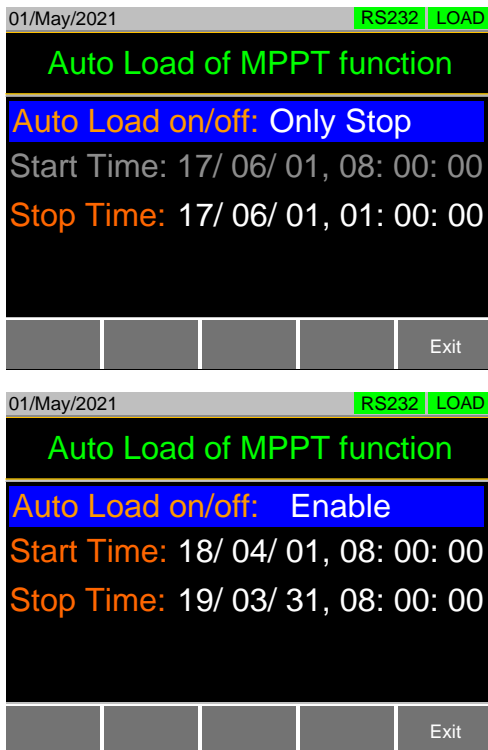

2. Set the following parameters.
  - Auto Load on/off
  - Start Time
  - Stop Time

---

#### Start MPPT

1. Insert a USB flash disk into USB port in the front panel.
  2. Press MPPT [F1] to enable this function to start the test.
  3. Press Shift + Load key to start the test.
  4. Continue testing until the end conditions are met.
-

Example: MPPT  
Function running

01/May/2021 RS232 MPPT

**0.071 v    0.466w**

**1.2197 A    0:00:00**

---

<b>Detect Pmax:</b>	Fetch Volt:	Fetch Watt:
Running...	0.305	0.385
Pmax: 0001	0.043	0.054
MPPT: 0000	0.043	0.054
	0.043	0.054

01/May/2021 RS232 MPPT

**0.512 v    0.644w**

**1.2596 A    0:00:03**

---

<b>Hill Climb:</b>	Fetch Volt:	Fetch Watt:
Pmax: 0.644	0.511	0.644
Pmax: 0001	0.510	0.643
MPPT: 0000	0.509	0.651
	0.507	0.639

Example: MPPT  
test results

01/May/2021 RS232 LOAD

**MPPT Result**    03:52:33 >> 04:01:50

Max Time:    03:52:45

Max Power:    8.54876 W, 4.072 V, 2.0994 A,

---

**Detect Pmax Result**    03:53:30

Max Power:    8.47195 W, 4.036 V, 2.0991 A,

Short Circuit:    No Search

Open Circuit:    4.093 V

Detect P <sup>max</sup>	MPPT Result	Save	Exit
-------------------------	-------------	------	------

To save the test result data, press Save [F3].

The maximum amount of data to be recorded in the data log is 65536. If data exceeds this limit, the extra data won't be recorded.

To see the graph of the maximum power point tracking test, press Detect P'max [F1].

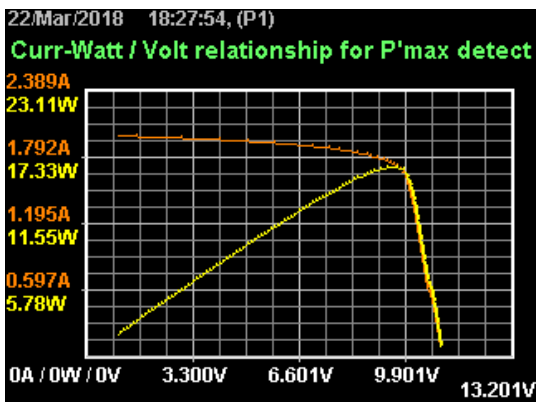

To see the graph of the MPPT exam, Press MPPT Result [F2].

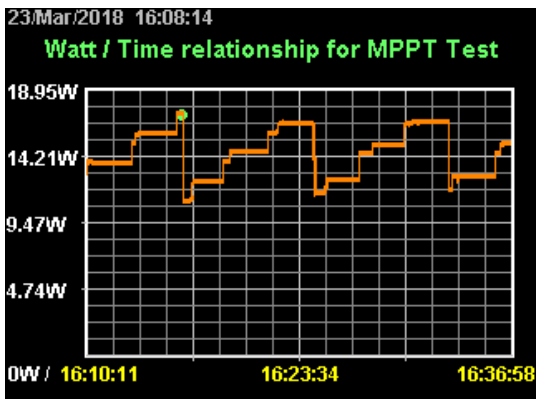

If you want to have a screen shot, press Save [F3]. Press Esc [F1] to exit.

## Data file of test result

**Background** Test result data is saved as a CSV file.

Example: Test conditions and results file

	A	B	C	D	E
1	<< MPPT TEST >>			LSG-1.75A	vl 29.001
2					
3	<DATE>	2018/3/22 18:37			
4	<Pmax Detection Method>				
5		(1)Memo:			
6		(2)Mode:	CV		
7		(3)Range:	IHV/L		
8		(4)Response:	Slow		
9		(5)Sweep Range:	Value		
10		(6)Start Voltage:		1 V	
11		(7)End Voltage:		11 V	
12		(8)Step Voltage:		0.1 V	
13		(9)Step Time:		1 sec	
14		(10)Short Circuit Detection:	Disable		
15	<Hill Climbing Method Tracking>				
16		(11)Tracking:	Enable		
17		(12)Tracking Step Voltage:		1 %	
18		(13)Tracking Step Time:		1 sec	
19		(14)Pmax Detection Time Interval:		10 min	
20	<Measurement condition>				
21		(15)Measurement Time Interval:		1 sec	
22					
23	<MPPT TEST RESULTS>				
24		(1)Start Time	2018/3/22 18:37		
25		(2)End Time	2018/3/22 18:43		
26		(3)MAX No.	108		
27		(4)MAX Time	2018/3/22 18:40		
28		(5)MAX Voltage	9.49 V		
29		(6)MAX Current	1.754 A		
30		(7)MAX Power	16.645462 W		

- <DATE> Date of test
- <Pmax Detection Method> Settings contents for Pmax detection (in CV mode).
- <Hill Climbing Method Tracking> Setting contents of the hill climbing method.
- <Measurement condition> Measurement status.
- <MPPT TEST RESULTS> MPPT test results.
  - (1) Start Time Test start time
  - (2) End Time Test end time
  - (3) MAX No. Number of measurement data
  - (4) MAX Time Time when Pmax is maximum
  - (5) MAX Voltage Voltage value when Pmax is maximum
  - (6) MAX Current Current value when Pmax is maximum
  - (7) MAX Power Power value when Pmax is maximum



Example: Results  
file of IV and PV  
characteristics test

	A	B	C	D
1				
2	<P MAX DETECTION RESULTS>			
3		(1)Start Time	2018/3/22 18:37	
4		(2)MAX No	86	
5		(3)MAX Voltage	9.6 V	
6		(4)MAX Current	1.719 A	
7		(5)MAX Power	16.502401 W	
8		(6)Short Circuit	No Search	
9		(7)Open Circuit	1 V	
10		(8)DATA Lists	101	
11	No	VOLT(V)	CURR(A)	POWER(W)
12	1	1.1	1.99	2.189
13	2	1.2	1.989	2.3868
14	3	1.3	1.988	2.5844
15	4	1.4	1.987	2.7818
16	5	1.5	1.987	2.9805
17	6	1.6	1.986	3.1776
18	7	1.7	1.985	3.3745
19	8	1.8	1.984	3.5712
20	9	1.9	1.983	3.7677
21	10	2	1.982	3.964
22	11	2.1	1.981	4.1601
23	12	2.2	1.981	4.3582
24	13	2.3	1.98	4.554001
25	14	2.4	1.979	4.7496
26	15	2.5	1.978	4.945
27	16	2.6	1.977	5.140201
28	17	2.7	1.976	5.3352
29	18	2.8	1.973	5.524401
30	19	2.9	1.972	5.718801
31	20	3	1.971	5.913001
32	21	3.1	1.97	6.107001
33	22	3.2	1.969	6.3008
34	23	3.3	1.968	6.494401
35	24	3.4	1.966	6.684401
36	25	3.5	1.965	6.877501
37	26	3.6	1.964	7.070401
38	27	3.7	1.963	7.263101
39	28	3.8	1.962	7.455201

< P MAX DETECTION  
RESULTS >

Pmax detection results.

(1) Start Time

Test start time

(2) MAX No.

Data number when Pmax is maximum

(3) MAX Voltage

Voltage value when Pmax is maximum

(4) MAX Current

Current value when Pmax is  
maximum

(5) MAX Power

Power value when Pmax is maximum

(6) Short Circuit

No search

(7) Open Circuit

Test start voltage

(8) DATA Lists

Number of measurement data

No

Measurement data number

VOLT(V)

Measured voltage value

CURR(A) Measured current value

POWER(W) Measured power value

Example: Results file of MPPT test

	A	B	C
1	(1)Start Time	2018/3/22 19:00	
2	(2)End Time	2018/3/22 19:08	
3	VOLT(V)	CURR(A)	POWER(W)
4	9.501	1.737	16.50324
5	9.501	1.737	16.50324
6	9.501	1.737	16.50324
7	9.501	1.737	16.50324
8	9.548	1.737	16.58488
9	9.548	1.737	16.58488
10	9.524	1.737	16.54319
11	9.547	1.737	16.58314
12	9.57	1.737	16.62309
13	9.57	1.737	16.62309
14	9.583	1.737	16.64567
15	9.583	1.737	16.64567
16	9.577	1.737	16.63525
17	9.582	1.737	16.64394
18	9.587	1.737	16.65262
19	9.587	1.737	16.65262
20	9.589	1.737	16.6561
21	9.589	1.737	16.6561
22	9.589	1.737	16.6561
23	9.589	1.737	16.6561
24	9.589	1.737	16.6561
25	9.588	1.737	16.65436
26	9.588	1.737	16.65436
27	9.588	1.737	16.65436
28	9.588	1.737	16.65436
29	9.588	1.737	16.65436
30	9.588	1.737	16.65436
31	9.588	1.737	16.65436
32	9.588	1.737	16.65436
33	9.588	1.736	16.64477
34	9.587	1.737	16.65262
35	9.587	1.737	16.65262
36	9.587	1.737	16.65262
37	9.588	1.737	16.65436

- (1) Start Time Test start time
- (2) Stop Time Test end time
- VOLT(V) Measured voltage value
- CURR(A) Measured current value
- POWER(W) Measured power value

# E XTERNAL CONTROL

Analog Control .....	186
J1 Connector Overview .....	186
J3 port (PEL-3021AH/PEL-3041AH/PEL-3111AH).....	187
External Voltage Control - Overview .....	188
External Voltage Control – Operation.....	189
Adjust offset and full scale with variable resistor (PEL-3021AH/ PEL-3041AH/ PEL-3111AH) .....	193
External Resistance Control - Overview .....	194
External Resistance Control – Operation.....	195
Adjust offset and full scale with variable resistor (PEL-3021AH/ PEL-3041AH/ PEL-3111AH) .....	198
Turning the Load On using External Control.....	199
Load On/Off Status .....	201
External Control of the Range .....	201
I Range Status .....	202
External Trigger Signal.....	203
External Control of the Alarm .....	203
Alarm Status .....	204
Short Control.....	204
Monitor Signal Output.....	205
Trigger Signal Output.....	205
Current Monitor Output for PEL-3000A series.....	206
Current Monitor Output for PEL-3000AH series .....	207
Voltage Monitor Output (PEL-3021AH/ PEL-3041AH/PEL-3111AH) .....	208
Parallel Operation.....	209
Parallel Capacity, PEL-3021A, PEL-3041A, PEL-3111A .....	209
Parallel Capacity, PEL-3021AH, PEL-3041AH, PEL-3111AH.....	210
Parallel Capacity, PEL-3211A.....	210
Parallel Capacity, PEL-3211AH .....	211
Connection .....	211
Configuration.....	213
Turning the Load On .....	215
Disable Parallel Mode.....	215

## Analog Control

The Analog Control subsection describes how to use the J1 Frame Control Connector for voltage or resistance control. The J2 connector, located under the J1 connector is used for parallel control. See page 255 for details about the J1 and J2 connectors.

### J1 Connector Overview

**Description** The J1 External Control Connector is a standard Mil 20 pin connector (OMRON XG4A IDC plug). The connector is used for all analog control. The pins are used to determine what mode is used. See the appendix on page 255 to view the contact pin assignment of the J1 connector.



**WARNING**

Some pins on the frame control connector have the same potential as the front and rear terminals.

To prevent electric shock, ensure that the cover for both the J1 and J2 External Control connectors are used when the connectors are not in use.

**Pin Assignment**

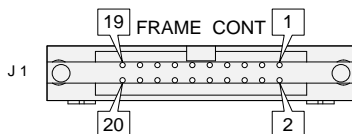

## J3 port (PEL-3021AH/PEL-3041AH/PEL-3111AH)

### Description

Use wire of 24 to 28 AWG to connect with J3 port. Please peel the coating of a wire approximately 10mm and then insert the wire to the terminal hole while pushing the button on the terminal hole of the J3.

To view the contact pin assignment of the J3, please see page 258 in the appendix chapter.



### WARNING

Please insert the wire to the hole of terminal J3 deeply. A conductor part of the wire, please do not come in contact with the frame and conductor part of other wire.

To prevent electric shock, ensure the cover for the J3.

### Pin Assignment

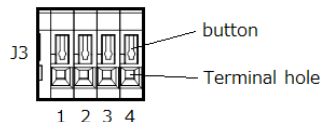

J3 Pin assignment	No		Name				
	1	I	MON	OUT	2	V	MON
3	A	COM	4	A	COM		

## External Voltage Control - Overview

**Background** External voltage control of the CC, CR, CV, CP and Cx+CP mode is accomplished using the J1 connector on the rear panel. An input voltage of 0-10V corresponds to 0% - 100% of the rated current (CC mode), rated voltage (CV mode), or rated power (CP mode). For CR mode, 0V - 10V corresponds to the maximum resistance - minimum resistance.

**Connection** When connecting the external voltage source to the J1 connector, use a ferrite core and use twisted pair wiring.

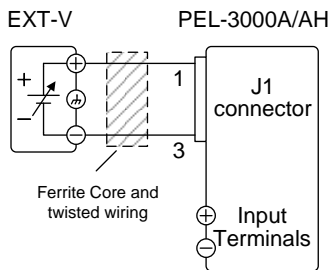

- Pin1 → EXT-V (+)
- Pin3 → EXT-V (-)

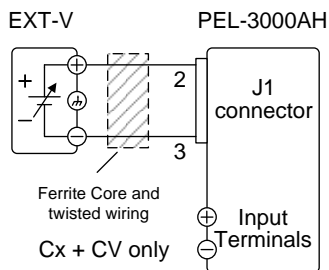

- Pin2 → EXT-V (+)
- Pin3 → EXT-V (-)



Note

The input impedance for external voltage control is 10kΩ.

Use a stable voltage supply for the external voltage control.



Caution

When using external voltage control, make sure no more than ±11V is applied across pins 1 and 3. Exceeding this voltage could damage the PEL-3000A/AH. Exceeding 11.8V will cause an EXT.OV alarm message to appear which also will reset the voltage output to 0V until the external voltage is reduced back down below 11.8V.

Use caution when using pin 3. Pin 3 is directly coupled to the negative input terminal.

### External Voltage Control – Operation

Description

External voltage control can be used to control the current, voltage, resistance and power for CC, CR, CV, CP and Cx+CV modes. Configuration for each operating mode is the same.

Panel operation



1. Press **Main** + > *Configure*[F5] > *Next Menu*>*External*[F4].
2. Set the Control setting is set to V.

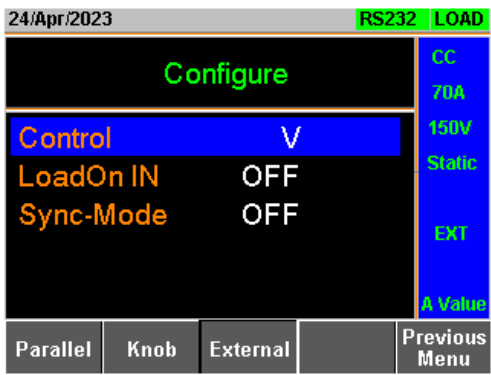



Note

Under EXTERNAL Control, the panel or remote command will no more control the unit. The front panel will show the icon “EXT”. In brief, just use: EXT OFF to disable and turn it back to normal control, or applying Load Default Setting to prevent electric shock, ensure the cover for the J3.

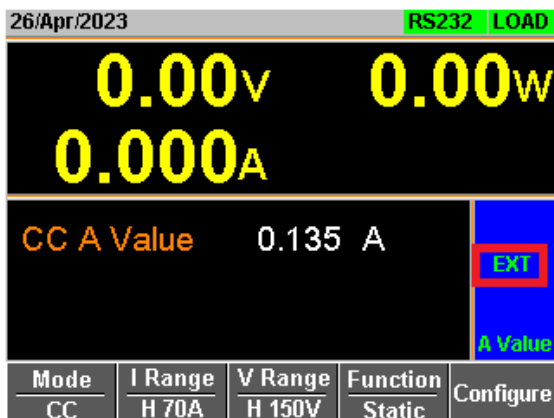

CC Mode

Input current = rated current × (external voltage/10)

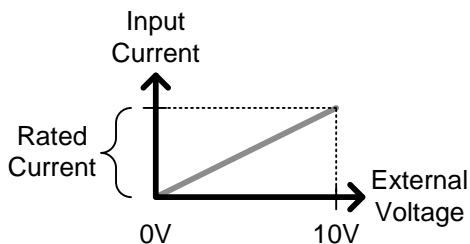



CR Mode

Input conductance =  
 rated conductance  $\times$  (external voltage/10)

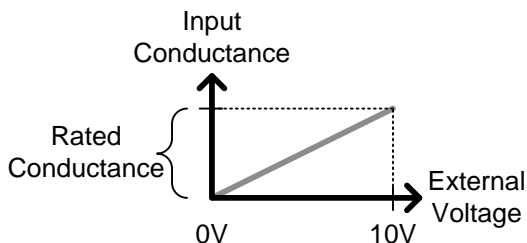

CV Mode

Cx+CV Mode

Input voltage = rated voltage  $\times$  (external  
 voltage/10)

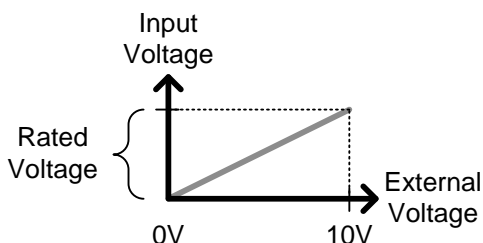

CP Mode

Input power = rated power  $\times$  (external voltage/10)

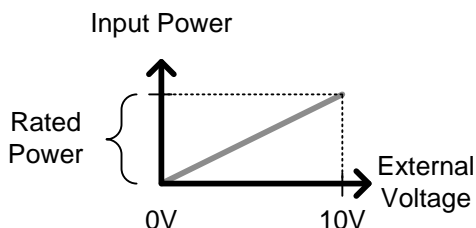

Operation

1. Turn the power off from the PEL-3000A/AH and from the load.
2. Connect the external voltage across pins 1 and 3 of the J1 connector.
3. Turn the power on the PEL-3000A/AH.
4. Set the operating mode and range.
  - See page 56 for CC mode.

- See page 58 for CR mode.
  - See page 60 for CV mode.
  - See page 61 for CP mode.
5. Press  > *Configure* [F5] > *Next Menu* [F4] > *External* [F3].
  6. Set the *Control* parameter to V.
    - The J1 connector is now ready for external voltage control.

Adjust offset and full scale with variable resistor (PEL-3021AH/  
PEL-3041AH/ PEL-3111AH)

Variable Resistor  
in rear panel

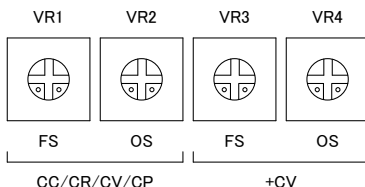

Operation  
CC, CR, CV, CP  
Mode

1. Apply a voltage of 1V to pin J1-1 based on the level of pin J1-3.
2. Turn VR2 with screwdriver to adjust the value to 10% of the rating in each the operating mode.
3. Apply a voltage of 10V to pin J1-1 based on the level of pin J1-3.
4. Turn VR1 with screwdriver to adjust the value to 100% of the rating in each the operating mode.
5. Apply a voltage of 1V to pin J1-1 based on the level of pin J1-3.
6. Turn VR2 with screwdriver to adjust the value to 10% of the rating in each the operating mode.



Readjustment is needed when you use a different operating mode, current range or voltage range.

Cx+CV mode

1. Apply a voltage of 1V to pin J1-1 based on the level of pin J1-3.
2. Turn VR4 with screwdriver to adjust the value to 10% of the rating in each +CV mode.
3. Apply a voltage of 10V to pin J1-2 based on the level of pin J1-3.
4. Turn VR3 with screwdriver to adjust the value to 100% of the rating in each +CV mode.
5. Apply a voltage of 1V to pin J1-2 based on the

level of pin J1-3.

6. Turn VR4 with screwdriver to adjust the value to 10% of the rating in each +CV mode.



Note

Readjustment is needed when you use a different voltage range.

## External Resistance Control - Overview

### Background

External resistance control of the CC, CR, CV and CP modes is accomplished using the J1 connector on the rear panel.

A resistance of 0kΩ-10kΩ is used to control the input current, voltage, resistance or power on the PEL-3000A/AH.

The input can be configured to vary in proportion to the external resistance or the inverse. See page 195 for more details on proportional and inverse resistance control.



Note

Exceeding 11.8kΩ will cause an EXT.OV alarm message which will reset the voltage output to 0 until the external resistance is reduced back down below 11.8kΩ.

### Connection

When connecting the external resistance source to the J1 connector, use a ferrite core and use twisted pair wiring.

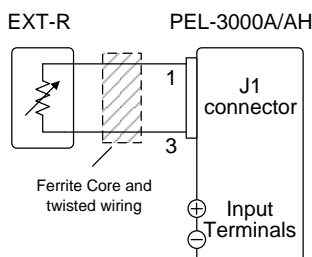

- Pin1 → EXT-R
- Pin3 → EXT-R



Note

Use resistors with minimum residual resistance of 50Ω or less.

Note for proportional control: Do not use switches that switch between fixed resistances. Please use continuously variable resistors.

### External Resistance Control – Operation

**Description** External resistance control can be used to control the current, voltage, resistance and power for CC, CR, CV and CP modes. Configuration for each operating mode is the same.

**CC Mode**

**Proportional Control:**  
 Input current = rated current × (external resistance/10).

**Inverse Control:**  
 Input current = rated current × (1 - external resistance/10).

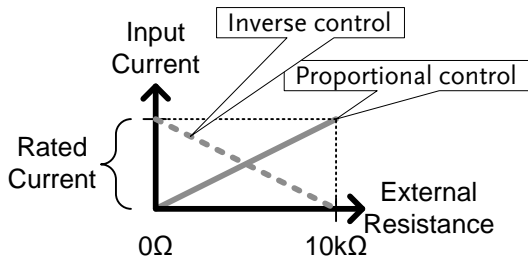

**Description** External resistance control can be used to control the current, voltage, resistance and power for CC, CR, CV and CP modes. Configuration for each operating mode is the same.

CC Mode

Proportional Control:

Input current = rated current × (external resistance/10).

Inverse Control:

Input current = rated current × (1 - external resistance/10).

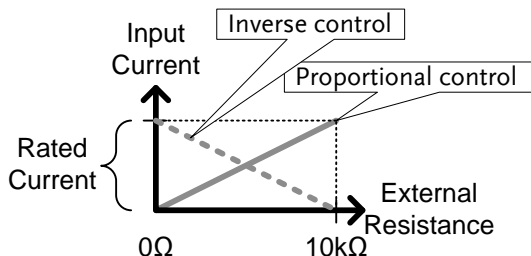

CR Mode

Proportional Control:

Input conductance = rated conductance × (external resistance/10).

Inverse Control:

Input conductance = rated conductance × (1 - external resistance/10).

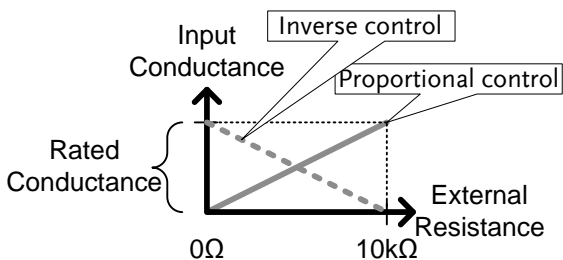

CV Mode

Proportional Control:

Input voltage = rated voltage × (external resistance/10).

Inverse Control:

Input voltage = rated voltage × (1 - external resistance/10).

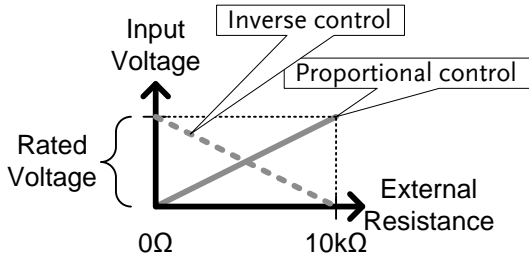

CP Mode

Proportional Control:

Input power = rated power × (external resistance/10).

Inverse Control:

Input power = rated power × (1 - external resistance/10).

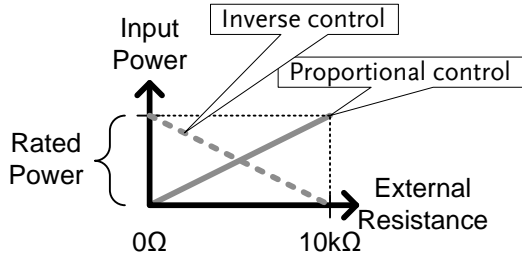

Note

The inverse configuration is recommended for safety reasons. In the event that any of the cables become accidentally disconnected, the current/voltage/power input will drop to the minimum. Under similar circumstances using proportional control, an unexpectedly high input would result.

Operation

1. Turn the power off from the PEL-3000A/AH and from the load.

2. Connect the external resistance across pins 1 and 3 of the J1 connector.
3. Turn the power on the PEL-3000A/AH.
4. Set the operating mode and range.
  - See page 56 for CC mode.
  - See page 58 for CR mode.
  - See page 60 for CV mode.
  - See page 61 for CP mode.
5. Press **Main** > *Configure* [F5] > *Next Menu* [F4] > *External* [F3].
6. Set the *Control* to *R* for proportional control or to *Rinv* for inverse control.
  - The J1 connector is now ready for external resistance control.

### Adjust offset and full scale with variable resistor (PEL-3021AH/ PEL-3041AH/ PEL-3111AH)

Variable Resistor  
in rear panel

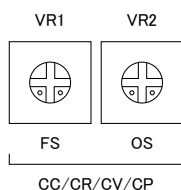

Operation

Proportional  
control

1. Connect 1kΩ between J1-1 and J1-3.
2. Turn VR2 with screwdriver to adjust the value to 10% of the rating in each the operating mode.
3. Connect 10kΩ between J1-1 and J1-3.
4. Turn VR1 with screwdriver to adjust the value to 100% of the rating in each the operating mode.



5. Connect 1kΩ between J1-1 and J1-3.
6. Turn VR2 with screwdriver to adjust the value to 10% of the rating in each the operating mode.



Note

Readjustment is needed when you use a different operating mode, current range or voltage range.

Inverse control

1. Connect 9kΩ between J1-1 and J1-3.
2. Turn VR2 with screwdriver to adjust the value to 10% of the rating in each the operating mode.
3. Connect 1kΩ between J1-1 and J1-3.
4. Turn VR1 with screwdriver to adjust the value to 90% of the rating in each the operating mode.
5. Connect 9kΩ between J1-1 and J1-3.
6. Turn VR2 with screwdriver to adjust the value to 10% of the rating in each the operating mode.



Note

Readjustment is needed when you use a different operating mode, current range or voltage range.

## Turning the Load On using External Control

**Description**      The load can be turned on and off with an external switch connected to pins 7 and 12 of the J1 connector.

**Pin Inputs**      Pin 7 of the J1 connector is internally pulled up to 5V with a 10kΩ resistor when the switch is open. Thus when the switch is open, pin 7 is logically high. When the switch is closed, pin 7 is pulled down to the A COM ground level, making pin 7 logically low.

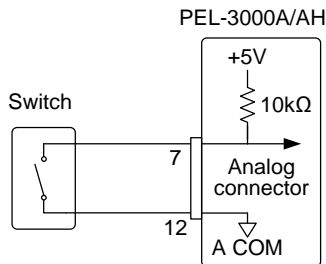

**Example**

The LoadOn IN setting determines whether the load is turned on when the external switch is closed (low) or open (high).

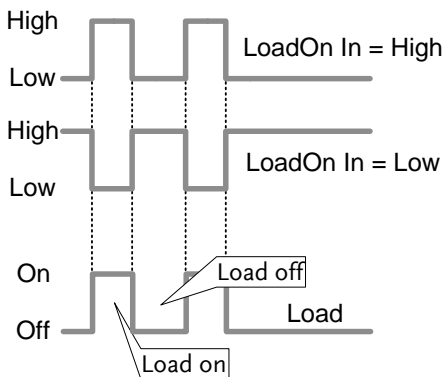

**Operation:  
Configuration**

1. Press **Main** > *Configure [F5]* > *Next Menu [F4]* > *External [F3]* and set the *LoadOn IN* setting.
  - Set to Low if you want the load to be turned on when the switch is closed.
  - Set to High if you want the load to turn on when the switch is open.

 **Note**

When external control is used to turn the load off, the load key cannot be used to turn the load on. However the reverse is not true. If the load has been turned on by external control, the load key can be used to turn the load off.

### Load On/Off Status

**Description** Pin 13 (Load On Status) of the J1 connector is used to monitor the load status (on or off).

**Pin out** The Load On Status pin is a photo-coupled open-collector output.

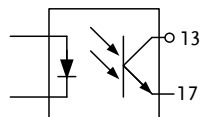

Photocoupler input: 30V max, 8mA, max.

### External Control of the Range

**Description** The range for the present operating mode can be externally controlled when the current range is set to high range.

The range is changed using pins 8, 9 (Range Cont 1 & 2) and 12 (A Com) of the J1 connector.

When externally controlling the range, the pin input combination determines which range is chosen.



Note

1. Press **Main** > Configure [F5] > Next Menu [F4] > External [F3] and set the Control setting to V, R or Riv to enable external control.
2. When externally controlling the range, the pin input combination determines which range is chosen.

I Range	Pin 9	Pin 8
H	High	High
M	High	Low
L	Low	High

**Pin Inputs**

Pins 8 and 9 of the J1 connector are internally pulled up to 5V with a 10kΩ resistor when open. When closed, pin 8 and 9 are pulled down to the A COM ground level.

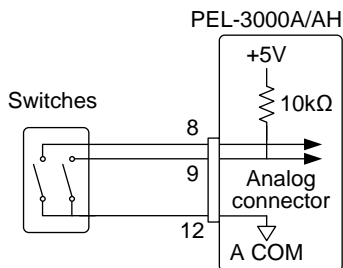

**Note**

The range can only be externally controlled when the IRange has been set to High using the front panel controls.

**I Range Status**

**Description**

Pins 14 and 15 (Range Status 1& 0) of the J1 connector are used to monitor the IRange status.

The pinout combination determines the range status.

I Range	Pin 15	Pin 14
H	Off	Off
M	Off	On
L	On	Off

**Pin out**

The Range Status pins are photo-coupled open-collector outputs.

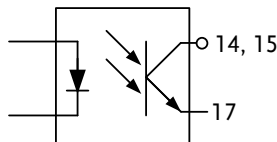

Photocoupler input: 30V max, 8mA, max.

## External Trigger Signal

Description	Pins 11 and 12 of the J1 connector are the trigger signal inputs. The trigger signal is used to resume a sequence after a pause. This action is useful to synchronize the execution of a sequence with another device.
Pin out	Pin 11 of the J1 connector is internally pulled down to A COM with an approx. 100k $\Omega$ resistor. To use the trigger input, an active high TTL pulse of 10 $\mu$ s or more is required.

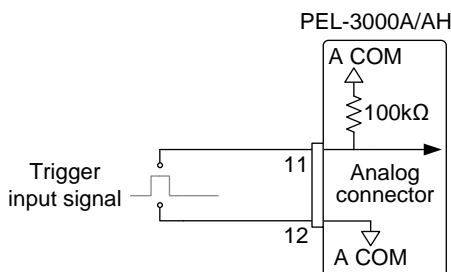

## External Control of the Alarm

Description	<p>An alarm can be activated/deactivated using external control with the J1 connector (pins 10, 12). When the alarm is activated, an EXT.AL message is also output. The alarm can be activated by an external device or by a parallel slave unit.</p> <p>The alarm is activated by sending a low-level signal. The operating threshold level is TTL.</p>
Pin Inputs	Pin 10 is internally pulled up to 5V with a 10k $\Omega$ resistor when open. When closed, pin 10 is pulled down to the A COM ground level.



Note

Before using the External Control of the Alarm function, please change the Parallel menu setting to Master Manual first.

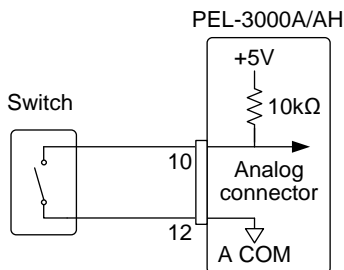

## Alarm Status

### Description

Pins 16 and 17 of the J1 connector are used to monitor whether the alarm is on or off.

### Pin out

The Alarm Status pin is a photo-coupled open-collector output.

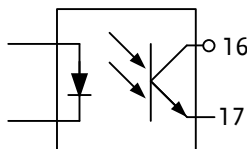

Photocoupler input: 30V max, 8mA, max.

## Short Control

### Description

The Short Signal Out pins (19 and 20) are 30VDC 1A relay contact outputs. These outputs can be used to drive an external relay to physically short the terminal outputs.

### Pin Inputs

The Short Signal Out pins are normally open until the short function is activated.

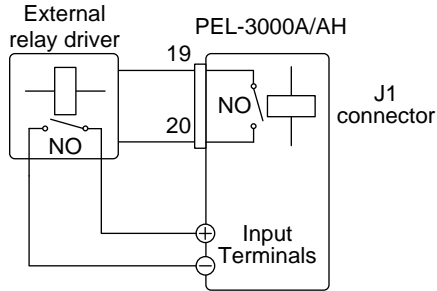

Note

The external relay driver is not a standard accessory. Please provide your own external relay and driver circuit.

## Monitor Signal Output

### Trigger Signal Output

#### Description

The trigger output signal is generated every time a switching operation is performed (i.e., Dynamic mode) or when a Fast or Normal Sequence is executed and the TRIG OUT parameter is enabled.

The trigger output signal from TRIG OUT BNC is a 5V pulse of at least  $2.5\mu\text{s}$  with an impedance of  $500\Omega$ . The common potential is connected to the chassis potential. The signal threshold level is TTL.

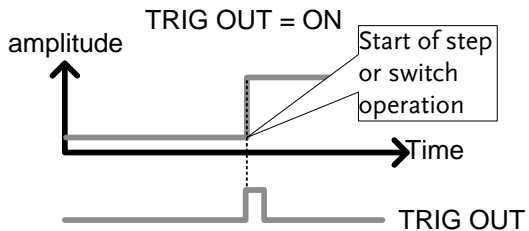

## Current Monitor Output for PEL-3000A series

**Description** The voltage output from the IMON OUT terminal and from the IMON pin on the J1 connector is used to represent the current input level.

The voltage range used to represent the full scale current range from the IMON OUT terminal and from the IMON pin on the J1 connector depends on the current range settings.

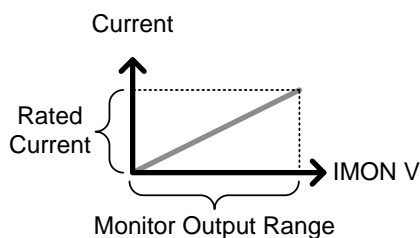

Monitor Connector	Current Range	Monitor Output Range
I MON OUT (BNC)	H, L	0 - 1V
	M	0 - 0.1V
I MON (J1)	H, L	0 - 10V
	M	0 - 1V

**I MON OUT BNC Connector** The IMON OUT BNC connector outputs a voltage of 0 - 1V for the High and Low current ranges and 0 - 0.1V for the Middle current range. The common potential is connected to the chassis ground potential.

**J1 Connector** The voltage across pins 2 and 3 outputs a voltage of 0 -10V for the High and Low current ranges and 0 - 1V for the Middle current range. The common potential is connected to A COM (negative load terminal).



**Current Monitor Output for PEL-3000AH series**

**Description** The voltage output from the IMON OUT terminal and from the IMON pin on the J3 connector is used to represent the current input level.

The voltage range used to represent the full scale current range from the IMON OUT terminal and from the IMON pin on the J3 connector depends on the current range settings.

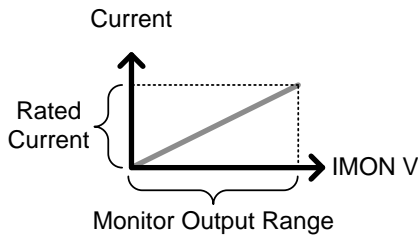

Monitor Connector	Current Range	Monitor Output Range
I MON OUT (BNC)	H, L	0 - 10V
	M	0 - 1V
I MON (J3)	H, L	0 - 10V
	M	0 - 1V

**I MON OUT BNC Connector** The IMON OUT BNC connector outputs a voltage of 0 - 10V for the High and Low current ranges and 0 - 1V for the Middle current range. The common potential is connected to the chassis ground potential.

**J3 Connector** The voltage across pins 1 and 3 (or 4) outputs a voltage of 0 - 10V for the High and Low current ranges and 0 - 1V for the Middle current range. The common potential is connected to A COM (negative load terminal).

## Voltage Monitor Output

(PEL-3021AH/PEL-3041AH/PEL-3111AH)

**Description** The voltage output from the VMON OUT terminal and from the VMON pin on the J3 connector is used to represent the current input level.

The V Range used to represent the full scale current range from the VMON OUT terminal and from the VMON pin on the J3 connector depends on the current range settings.

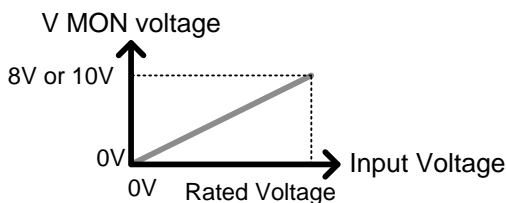

Monitor Connector	Voltage Range	Monitor Output Range
V MON OUT (BNC)	H, L	0 - 8V
V MON (J3)	H, L	0 - 10V

**V MON OUT BNC Connector**

The V MON OUT BNC connector outputs a voltage of 0 - 8V for the High and Low voltage ranges. The common potential is connected to the chassis ground potential.

**J3 Connector**

The voltage across pins 2 and 3 (or 4) outputs a voltage of 0 -10V for the High and Low voltage ranges. The common potential is connected to A COM (negative load terminal).

## Parallel Operation

The PEL-3000A/AH series can be connected in parallel to increase the total power capacity of a single unit.

The PEL-3000A/AH series can operate with up to 5 units in parallel. A single unit is designated as a master unit and any other connected units as slaves.

Only units of the same type and rating can be used in parallel or alternatively, the PEL-3211A/AH booster pack can be used as a slave with the PEL-3111A/AH.

When a master unit is used in parallel mode, to ensure stability, the response speed will drop down to 1/2 if it was originally 1/1. You can however, reset the response speed back (or to another value) in the Main>Configure menu.

### Parallel Capacity, PEL-3021A, PEL-3041A, PEL-3111A

Model	Single Unit	2 Units	3 Units	4 Units	5 Units
PEL-3021A	150V	150V	150V	150V	150V
	35A	70A	105A	140A	175A
	175W	350W	525W	700W	875W
PEL-3041A	150V	150V	150V	150V	150V
	70A	140A	210A	280A	350A
	350W	700W	1050W	1400W	1750W
PEL-3111A	150V	150V	150V	150V	150V
	210A	420A	630A	1680A	1050A
	1050W	2100W	3150W	4200W	5250W

**Parallel Capacity, PEL-3021AH, PEL-3041AH, PEL-3111AH**

Model	Single Unit	2 Units	3 Units	4 Units	5 Units
PEL-3021AH	800V	800V	800V	800V	800V
	8.75A	17.5A	26.25A	35A	43.75A
	175W	350W	525W	700W	875W
PEL-3041AH	800V	800V	800V	800V	800V
	17.5A	35A	52.5A	70A	87.5A
	350W	700W	1050W	1400W	1750W
PEL-3111AH	800V	800V	800V	800V	800V
	52.5A	105A	157.5A	210A	262.5A
	1050W	2100W	3150W	4200W	5250W

**Parallel Capacity, PEL-3211A**

Model	No. of Units	V	I	Total Sink Current PEL-3111A+ PEL-3211A	Total Power PEL-3111A + PEL-3211A
PEL-3111A: Master	x 1	150V	210A	N/A	N/A
	x 1	150V	420A	630A	3150W
PEL-3211A: Slave Boosters	x 2	150V	840A	1050A	5250W
	x 3	150V	1260A	1470A	7350W
	x 4	150V	1680A	1890A	9450W



Note

The PEL-3211A booster packs do not have a control panel. They can only be used as slaves with a single PEL-3111A in parallel.

### Parallel Capacity, PEL-3211AH

Model	No. of Units	V	I	Total Sink Current PEL-3111AH+ PEL-3211AH	Total Power PEL-3111AH + PEL-3211AH
PEL-3111AH: Master	x 1	800V	52.5A	N/A	N/A
	x 1	800V	105A	157.5A	3150W
PEL-3211AH: Slave Boosters	x 2	800V	210A	262.5A	5250W
	x 3	800V	315A	367.5A	7350W
	x 4	800V	420A	472.5A	9450W

 **Note** The PEL-3211AH booster packs do not have a control panel. They can only be used as slaves with a single PEL-3111AH in parallel.

### Connection

**Description** The J1 and J2 connectors are used for control during parallel operation. Up to 5 units can be used in parallel.

 **Note** Only the rear panel terminals can be used for parallel operation, the front panel terminals have a lower current rating and thus should not be used for parallel operation.

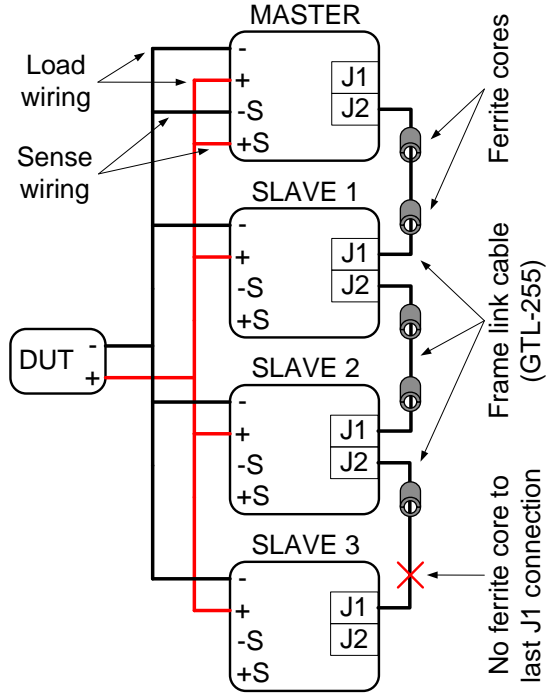

 **Cautions**

Only the rear terminals can be used for parallel connections.

Make sure all connections are correct before turning on the load. Incorrect connections could damage the units.

Only units of the same type and rating can be used in parallel (except for when the PEL-3211A/AH booster pack is used with the PEL-3111A/AH).

Ensure that wiring of sufficient gauge is used when using parallel connections.

If using remote sense, only connect the master to the voltage sense terminals.

## Configuration

---

Description	When using the multiple units in parallel all the basic settings are adopted from the master unit.
Operation	<ol style="list-style-type: none"> <li>1. Make sure all load units are turned off.</li> <li>2. Make sure the DUT is turned off.</li> <li>3. Connect the load units to the DUT. <ul style="list-style-type: none"> <li>• Ensure the wire gauge is sufficient to handle the increase in current</li> </ul> </li> <li>4. Connect the Master unit to the slave units via the J1/J2 connectors*. <ul style="list-style-type: none"> <li>• Use the GTL-255 frame link cables</li> <li>• Connect from: Master J2 → Slave1 J1 Slave1 J2 → Slave2 J1 and so on.</li> <li>• Remove one ferrite core from the last frame link cable. Remove the ferrite core that is closest to the J1 connector on the last slave unit. See the diagram below for details.</li> </ul> </li> <li>5. Turn the load units on. <ul style="list-style-type: none"> <li>• A maximum of 5 units can be used in parallel. A maximum of 4 boosters can be used with a single PEL-3111A/AH, acting as a master unit.</li> </ul> </li> </ol>



Cautions

The PEL-3000A/AH series products support automatic parallel detection mode as well.

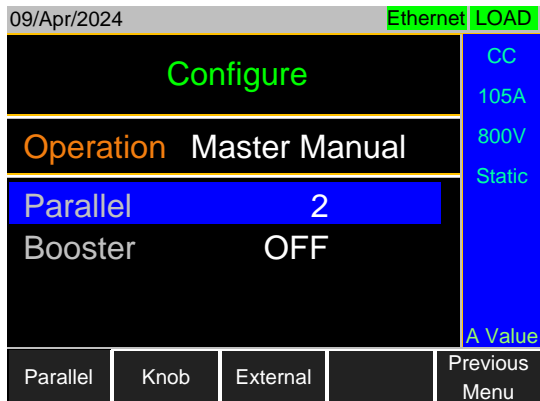

6. On the slave units, press **Main** > *Configure* [F5] > *Next Menu* [F4] > *Parallel*[F1] > and set *Operation* to *Slave*.

  - When in Slave mode, all keys are locked, except for the Scroll wheel and Enter key.

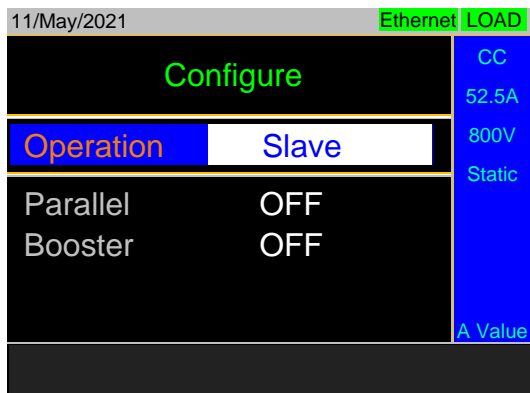

7. Please restart the system by turning off and on the power switch of the electronic load.

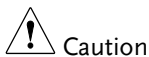

\*Failing to remove the last ferrite core from the GTL-255 cable may reduce the stability of the units when used in parallel.



## Turning the Load On

---

**Description** Operating the PEL-3000A/AH Series in parallel mode is the same as for single units.



**Note**

When using the units in parallel, the load line inductance could be increased or the stability of the units could be reduced. It may be necessary to reduce the response speed setting to increase stability.

1. Turn the slave and master units on.
2. Set the operation mode and settings on the master unit.
  - The master's settings will be used by the slave units.
3. Turn the load on from the Master unit.
  - All measurements will be displayed and updated on the Master unit only.

## Disable Parallel Mode

---

**Description** To disable parallel mode, each unit must be set as a "Master".

- Operation**
1. Turn the power off on all the units and remove the GTL-255 frame link cables.
  2. Turn the power back.
  3. On each unit, press  > *Configure [F5]* > *Next Menu [F4]* > *Parallel[F1]*.
  4. Set the unit to *Master* with the *Operation* setting.
  5. Turn the *Parallel* and *Booster* settings to *Off*.

# REMOTE CONTROL

This chapter describes basic configuration of IEEE488.2 based remote control. For a command list, refer to the programming manual, downloadable from GW Instek website, [www.gwinstek.com](http://www.gwinstek.com)

---

Interface Configuration .....	217
USB Interface Connection .....	217
Configure to USB Remote Interface .....	217
Configure GPIB Interface .....	217
Configure RS232 .....	219
Configure RS485 .....	220
Set the UART settings .....	221
Multiple Unit Connection .....	223
Multiple Units Function Check .....	224
RS232 or RS485/USB Remote Control Function Check .....	226
Using Realterm to Establish a Remote Connection .....	227
GPIB Function Check .....	230
Configuring Ethernet Connection .....	233
Socket Server Function Check .....	236
Web Server Function Check .....	242

## Interface Configuration



### USB Interface Connection

Connection For USB remote connection, use the USB-B port on the mainframe front panel. 

### Configure to USB Remote Interface

USB configuration	PC side connector	Type A, host
	PEL-3000A/AH side connector	Rear panel Type B, slave
	Speed	2.0 (full speed)
	USB Class	USB CDC ACM

 **Note** Before USB can be used for remote control, it is necessary to install the PEL-3000A/AH USB device driver which is downloadable from GW Instek website at <https://www.gwinstek.com/en-global/download/index>, PEL-3000A product corner.

- Operation
1. Connect the USB cable to the rear panel USB B port.
  2. Press  +  > *Interface*[F3] and set the *Interface* setting to *USB*.

### Configure GPIB Interface

To use GPIB, the optional GPIB port must be installed. See page 251 for installation details.

- Operation
1. Ensure the PEL-3000A/AH is off before proceeding.

2. Connect a GPIB cable from a GPIB controller to the GPIB port on the PEL-3000A/AH.
3. Turn the PEL-3000A/AH on.
4. Press **Shift** + **Utility Help** > *Interface[F3]* and set the *Interface* setting to *GPIB*.
5. Set the GPIB address.

GPIB address     0-30

- GPIB constraints
- Maximum 15 devices altogether, 20m cable length, 2m between each device
  - Unique address assigned to each device
  - At least 2/3 of the devices turned On
  - No loop or parallel connection

Pin Assignment

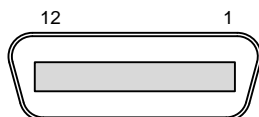

Pin	Signal	Pin	Signal
1-4	Data I/O 1-4	13-16	Data I/O 5-8
5	EOI	17	REN
6	DAV	18	Ground (DAV)
7	NRFD	19	Ground (NRFD)
8	NDAC	20	Ground (NDAC)
9	IFC	21	Ground (IFC)
10	SRQ	22	Ground (SRQ)
11	ATN	23	Ground (ATN)
12	SHIELD Ground	24	Single GND

## Configure RS232

RS232 Configuration	Connector	RJ-45
	Baud Rate	2400/ 4800/ 9600/ 19200/ 38400/ 57600/ 115200
	Data Bits	7bits/ 8bits
	Parity	None/ Odd/ Even
	Stop Bits	1,2

- Operation
1. Connect an RS232 series cable from the PC to the Remote IN port on the real panel.
  2. Connect the other end of the cable to the PC.

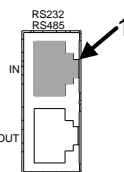

3. Press **Shift** + **Utility** **Help** > *Interface*[F3] and set the *Interface* setting to *UART*> *Mode* and set the *Mode* to *RS232*.
4. Edit the Baud rate, Data Bit, Parity and Stop bit.

## Configure RS485

RS485 Configuration	Connector	RJ-45
	Baud Rate	2400/ 4800/ 9600/ 19200/ 38400/ 57600/ 115200
	Data Bits	7bits/ 8bits
	Parity	None/ Odd/ Even
	Stop Bits	1,2
	Address	0~30

### Operation

1. Connect an RS485 series cable from the PC to the Remote IN port on the real panel.
2. Connect the other end of the cable to the PC.

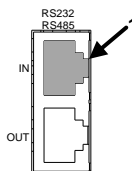

3. Press **Utility** + **Shift** + **Help** > *Interface[F3]* and set the *Interface* setting to *UART> Mode* and set the *Mode* to *RS485*.
4. Edit the Baud rate, Data Bit, Parity, Stop bit and Address.

## Set the UART settings

**Overview** The PEL-3000A/AH series uses the IN & OUT ports for UART communication coupled with RS232 (GW Instek Part number: GTL-259) or RS485 adapters (GW Instek part number: GTL-260).

The pin outs for the adapters are shown below.

RS232 cable with DB9 & RJ-45 shielded connectors from GTL-259 connection kit	DB-9 Connector		Remote IN Port		Remarks
	Pin No.	Name	Pin No.	Name	
	Housing	Shield	Housing	Shield	
	2	RX	7	TX	Twisted pair
	3	TX	8	RX	
5	SG	1	SG		

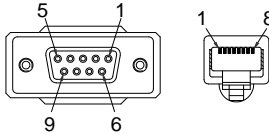

**Connection diagram**



RS485 cable with DB9 & RJ-45 shielded connectors from GTL-260 connection kit	DB-9 Connector		Remote IN Port		Remarks
	Pin No.	Name	Pin No.	Name	
	Housing	Shield	Housing	Shield	
	9	TXD -	6	RXD -	Twisted pair
	8	TXD +	3	RXD +	
	1	SG	1	SG	
5	RXD -	5	TXD -	Twisted pair	
4	RXD +	4	TXD +		

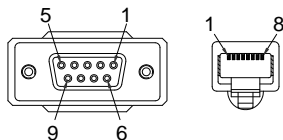

Connection diagram



Diagram of Intermediate connector

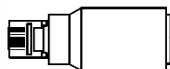

Intermediate connector from GTL-259 or GTL-260 connection kit.

Intermediate connector					
8 Pin (Male)			8 Pin (Female)		
Pin No.	Name		Pin No.	Name	Remarks
Housing	Shield	↔	Case	Shield	
1	SG	↔	1	SG	
6	TXD -	↔	6	TXD -	Internal paralleled by 120 ohm
3	TXD +	↔	3	TXD +	
5	RXD -	↔	5	RXD -	Internal paralleled by 120 ohm
4	RXD +	↔	4	RXD +	

Diagram of End terminal connector



End terminal connector from GTL-259 or GTL-260 connection kit.

End terminal connector	
8 Pin Connector	
Pin No.	Remarks
3	Internal shorted
7	
4	Internal shorted
8	



## Multiple Unit Connection

The PEL-3000A/AH can have up to 16 units daisy-chained together using the 8 pin connectors (IN OUT ports) on the rear panel. The first unit in the chain is remotely connected to a PC using RS485. Each subsequent unit is daisy-chained to the next using a RS485 local bus. The OUT port of the first unit must be connected to intermediate connector and the OUT port of the last unit must be connected to end terminal connector.



Each unit is assigned a unique address and can then be individually controlled from the host PC.

### Operation

1. Connect the first unit's IN port to a PC using RS485 serial cable. Use the serial cables supplied in the GTL-260 connection kit.
2. Plug in intermediate connector to the OUT port on the first unit then using the slave serial link cable (black plug) to connect intermediate connector to the IN port of the second unit.

Terminate the OUT port of the last unit with the end terminal connector included in the GTL-260 connection kit.

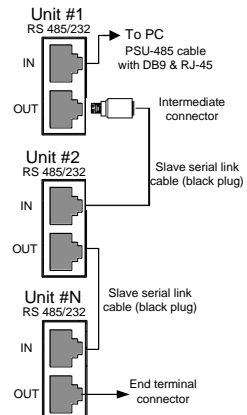

3. Power up all units.
4. Press **Shift** + **Help** <sup>Utility</sup> > *Interface[F3]* and set the *Interface* setting to *UART* > *Mode* and set the *Mode* to *RS485*.
5. Set the addresses and mode of all units using *UART* menu. It must be a unique address identifier and mode select is *RS485*.

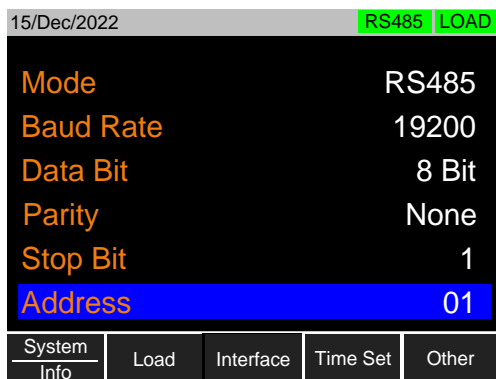

6. Multiple units can be operated using SCPI commands now. See the programming manual or see the function check below for usage details.

## Multiple Units Function Check

---

Functionality check

Invoke a terminal application such as Realterm.  
To check the COM port No, see the Device Manager in the PC.

For this function check, we will assume that the one unit is assigned to address 0, while other is assigned address 5.

ADR 0

OK

\*IDN?

GW Instek,PEL-3000A/AH,00000001, V2.41

VOLT 5

OK

VOLT?

+5.000

ADR is followed by address, which can be 0 to 30 and is used to access the electronic load.

Selects the unit with address 0 and returns its identity string. Also, sets its volt as 5 and returns its volt in 5.

---

ADR 5

OK

\*IDN?

GW Instek,PEL-3000A/AH,00000001, V2.41

VOLT 10

OK

VOLT?

+10.000

ADR is followed by address, which can be 0 to 30 and is used to access the electronic load.

Selects the unit with address 5 and returns its identity string. Also, sets its volt as 10 and returns its volt in 10.

---



Note

All setting command must return an “OK” response before any other commands are accepted. The electronic load acknowledges received commands by returning an “OK” message. If an error is detected the electronic load will return an error message.

---

## RS232 or RS485/USB Remote Control Function Check

---

Functionality  
check

Invoke a terminal application such as Realterm.

For RS-232C, set the COM port, baud rate, stop bit, data bit and parity accordingly.

The USB connection emulates a COM port on the PC. To check the COM settings in Windows, see the Device Manager. For example, for Win 7 go to the Control panel → Hardware and Sound → Device Manager.



Note

If you are not familiar with using a terminal application to send/receive remote commands from the serial port or via a USB connection, please page 227 (Using Realterm to Establish a Remote Connection) for more information.

---

Run this query command via the terminal after the instrument has been configured for RS-232C/USB remote control (page 219).

\*idn?

This should return the Manufacturer, Model number, Serial number, and Firmware version in the following format.

- GW-INSTEK,PEL-3000A/AH,  
XXXXXXXXXXXX, V.X.X.X.X

Manufacturer: GW-INSTEK

Model number : PEL-3000A/AH

Serial number : XXXXXXXXXXXX

Firmware version : V.X.X.X



Note

For further details, please see the programming manual, available on the GW Instek web site @ [www.gwinstek.com](http://www.gwinstek.com).

---

## Using Realterm to Establish a Remote Connection

---

**Background** Realterm is a terminal program that can be used to communicate with a device attached to the serial port of a PC or via an emulated serial port via USB.

The following instructions apply to version 2.0.0.70. Even though Realterm is used as an example to establish a remote connection, any terminal program can be used that has similar functionality.



Note

Realterm can be downloaded on Sourceforge.net free of charge.

For more information please see <http://realterm.sourceforge.net/>

---

**Operation**

1. Download Realterm and install according to the instructions on the Realterm website.
2. Connect the PEL-3000A/AH via USB (page 217) or via RS232 (page 219).
3. If using RS232, make note of the configured baud rate, stop bits and parity.
4. Go to the Windows device manager and find the COM port number for the connection. For example, go to the Start menu > Control Panel > Device Manager

Double click the *Ports* icon to reveal the connected serial port devices and the COM port for the each connected device.

If using USB, the baud rate, stop bit and parity settings can be viewed by right-clicking connected device and selecting the *Properties* option.

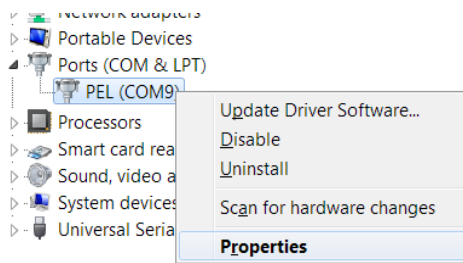

5. Start Realterm on the PC as an administrator.  
Click:  
Start menu>All Programs>RealTerm>realterm

Tip: to run as an administrator, you can right click the Realterm icon in the Windows Start menu and select the *Run as Administrator* option.

6. After Realterm has started, click on the *Port* tab.  
Enter the *Baud*, *Parity*, *Data bits*, *Stop bits* and *Port* number configuration for the connection.

The *Hardware Flow Control*, *Software Flow Control* options can be left at the default settings.

7. Press *Open* to connect to the PEL-3000A/AH.

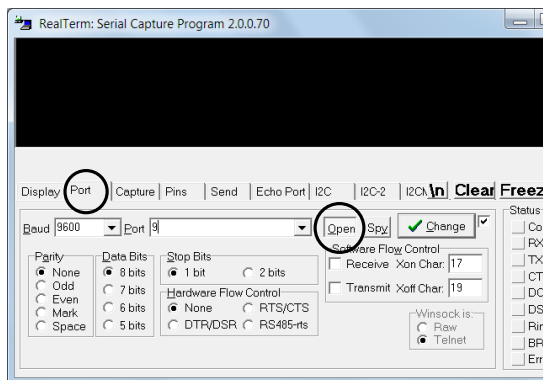

- Click on the *Send* tab.

In the *EOL* configuration, check on the *+CR* and *+LF* check boxes.

Enter the query:  
*\*idn?*

Click on *Send ASCII*.

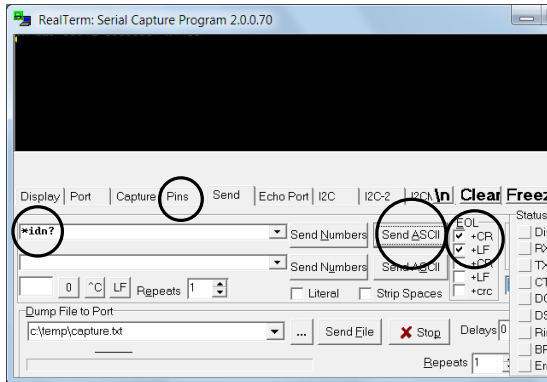

- The terminal display will return the following:  
 GW, PEL-3XXXA/AH,EXXXXXXXX,VX.XX.XXX  
 (manufacturer, model, serial number, version)
- If Realterm fails to connect to the PEL-3000A/AH, please check all the cables and settings and try again.

## GPIB Function Check

Functionality check      Please use the National Instruments Measurement & Automation Controller software to confirm GPIB functionality.

See the National Instrument website, <http://www.ni.com> for details.



Note

For further details, please see the programming manual, available on the GW Instek web site @ [www.gwinstek.com](http://www.gwinstek.com).

Operation

1. Start the NI Measurement and Automation Explorer (MAX) program. Using Windows, press:



Start>All Programs>National Instruments>Measurement & Automation

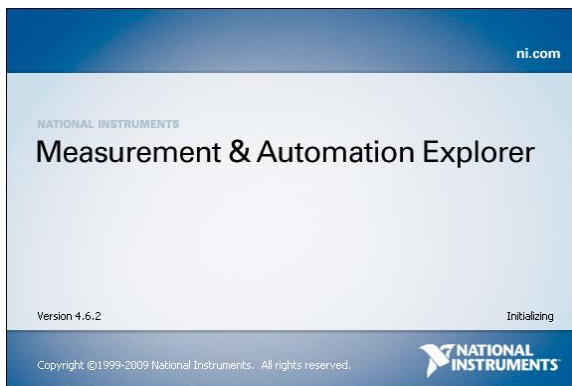

2. From the Configuration panel access;  
My System>Devices and Interfaces>GPIB0
3. Press the Scan for Instruments button.



4. In the *Connected Instruments* panel the PEL-3000A/AH should be detected as *Instrument 0* with the address the same as that configured on the PEL-3000A/AH.
5. Double click the *Instrument 0* icon.

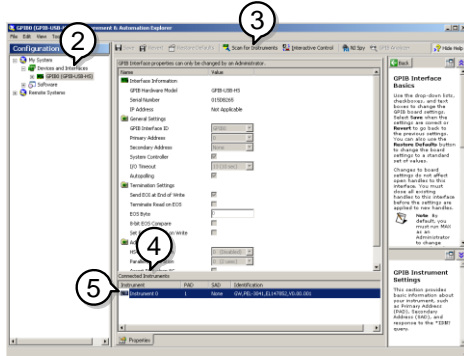

6. Click on *Communicate with Instrument*.
7. In the *NI-488.2 Communicator* window, ensure *\*IDN?* is written in the *Send String:* text box.

Click on the *Query* button to send the *\*IDN?* query to the instrument.

8. The *String Received* text box will display the query return:

GW, PEL-3XXXXA/AH,EXXXXXXXX,VX.XX.XXX  
(manufacturer, model, serial number, version)

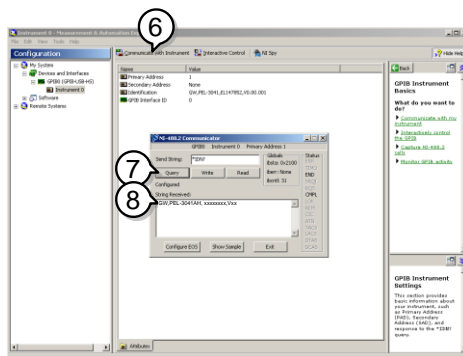

9. The function check is complete.



Note

For USB CDC function check, please refer to the section “RS232 and USB CDC function check” on page 221

## Configuring Ethernet Connection

**Background** When using Ethernet a number of parameters need to be set. These include DHCP On/Off, IP Address, Subnet Mask and Gateway. When setting Ethernet parameters, ensure they match that of the network.

<b>Parameters</b>	DHCP	On/Off			
	IP Address	0~255	0~255	0~255	0~255
	Subnet Mask	0~255	0~255	0~255	0~255
	Gateway	0~255	0~255	0~255	0~255

**Configuration** This configuration example will configure the PEL-3000A/AH socket server.  
The following configuration settings will manually assign the PEL-3000A/AH an IP address and enable the socket server. The socket server port number is fixed at 2268.

- Steps**
1. Connect an Ethernet cable from the network to the rear panel Ethernet port. You will see the led indicator next to Ethernet port lighting.



Rear panel of PEL-3000A      Rear panel of PEL-3000AH

2. Power on the PEL-3000A/AH.

**Panel operation**

3. Press the Shift key then the Help key to access the Utility menu.

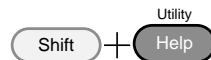

4. Press F3 (Interface Menu).

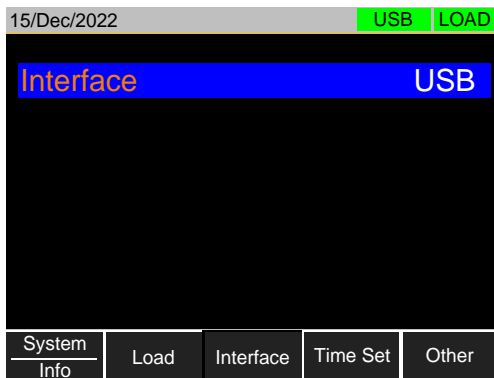

5. If the Interface mode is not Ethernet, use the Selector knob to edit Interface.

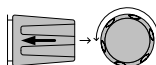

6. Choose Ethernet.



7. Press the Selector knob to confirm.

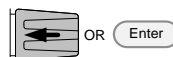

8. The Ethernet Menu appears.

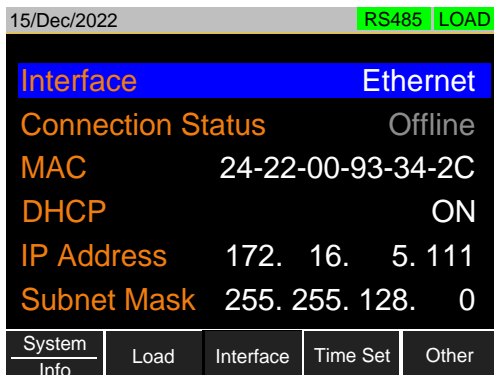

9. Use the Selector knob to edit DHCP, IP Address, Subnet Mask and Gateway setting.

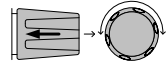

Note

If the DHCP set to ON, the IP Address, Subnet Mask and Gateway settings will be configured by the DHCP Server of the network automatically. These settings will show up after the PEL-3000A/AH get the information by DHCP.



Note

If the DHCP set to OFF, make sure the IP address, Subnet Mask, and Gateway settings match that of the network.

## Socket Server Function Check

**Background** To test the socket server functionality, National Instruments Measurement and Automation Explorer can be used. This program is available on the NI website, [www.ni.com](http://www.ni.com), via a search for the VISA Run-time Engine page, or “downloads” at the following URL, <http://www.ni.com/visa/>

**Requirements** Operating System: Windows XP, 7, 8, 10

- Functionality check**
1. Start the NI Measurement and Automation Explorer (MAX) program. Using Windows, press:  
Start>All Programs>National Instruments>Measurement & Automation
  2. From the Configuration panel access;  
My System>Devices and Interfaces>Network Devices
  3. Press Add New Network Device>Visa TCP/IP Resource.

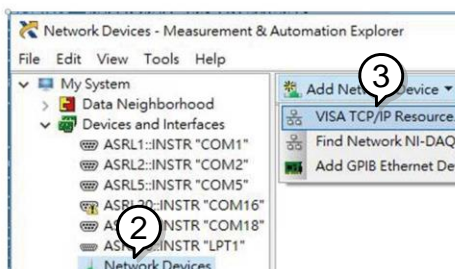

4. Select *Manual Entry of Raw Socket* from the popup window.

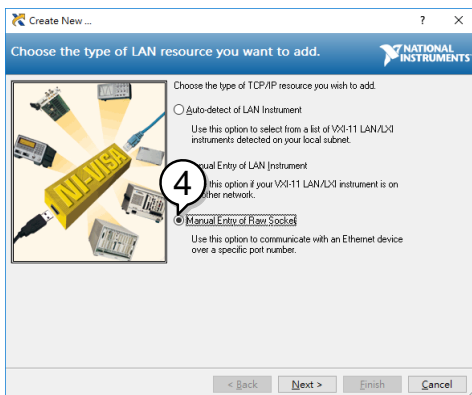

5. Enter the IP address and the port number of the PEL-3000A/AH. The port number is fixed at 2268.
6. Click the Validate button.

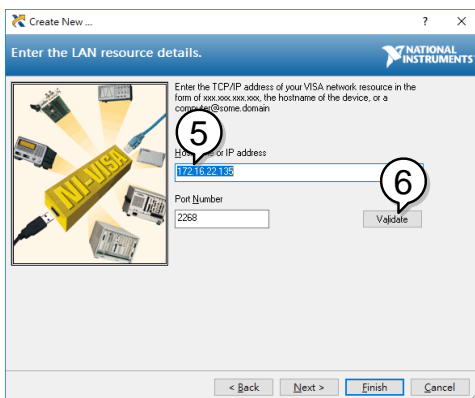

7. A popup will appear if a connection is successfully established. If not, check the Load device IP address configure. Then click OK button and Next button.

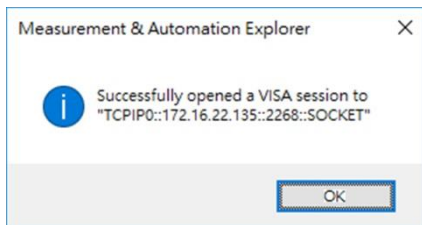

8. Click the Finish button.

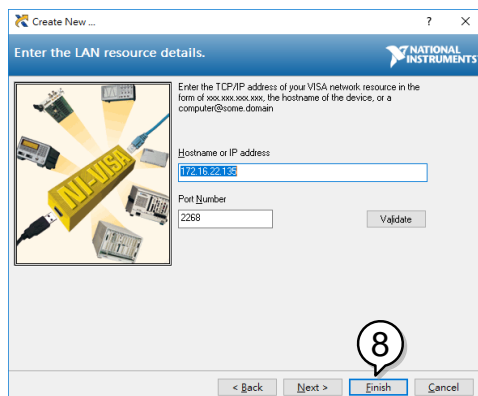

9. You can see the network device is setup successful. Click *Open VISA Test Panel*.

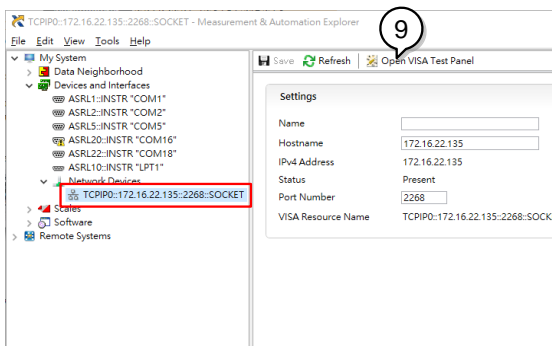

10. In the TCP/IP Settings page. You can see the information of TCP/IP.



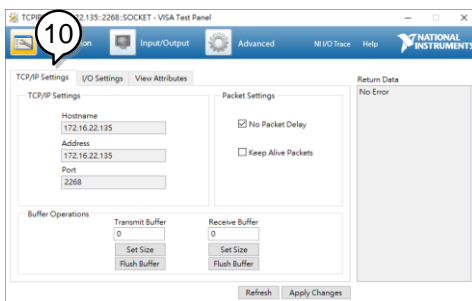

11. Click on I/O Settings.
12. Make sure the *Enable Termination Character* check box is checked, and the terminal character is \n (Value: xA).
13. Click *Apply Changes*.

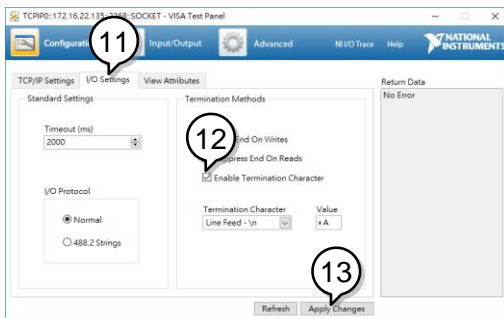

14. Click the *Input/Output* icon.
15. Enter *\*IDN?\n* in the *Select or Enter Command* dialog box if it is not already.

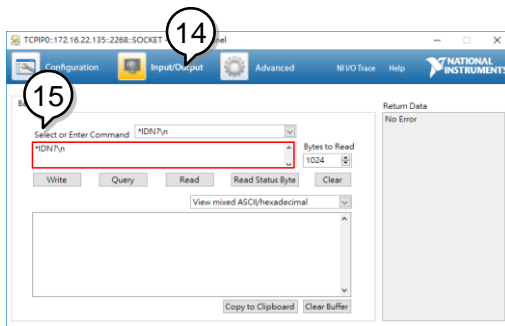

16. Click the *Query* button.

17. The \*IDN?\n query will return the Manufacturer, model name, serial number and firmware version in the dialog box.

GW Instek,PEL-3000A/AH,00000001, V108\n

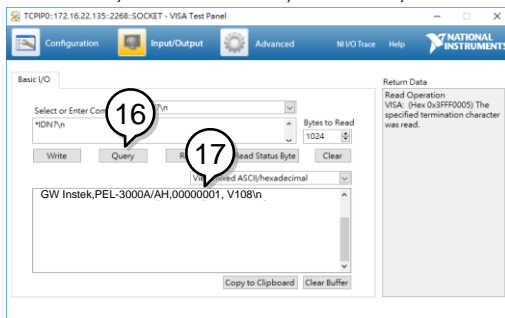

18. You can key in the command “:SYST:ERR\n”

19. Click the *Query* button. You will get the return messagn of error.



## Web Server Function Check

Functionality check

The web server allows you to check the function settings of the PEL-3000A/AH.

Enter the IP address of the PEL-3000A/AH in a web browser.

The web browser interface appears.

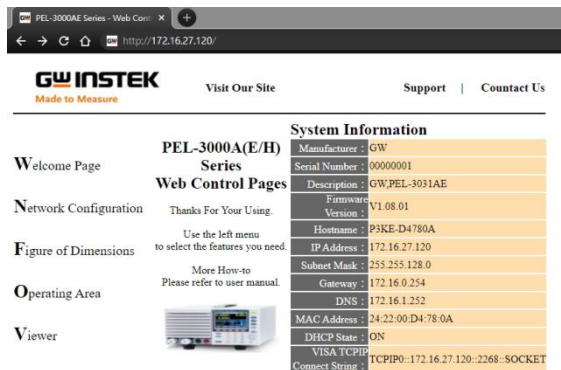

Copyright 2019 © Good Will Instrument Co., Ltd All Rights Reserved.

The web browser interface allows you to access the following:

- Network configuration settings
  - PEL-3000A/AH dimensions
  - Operating area diagram
1. You can click the Network Configuration to see the configuration information.

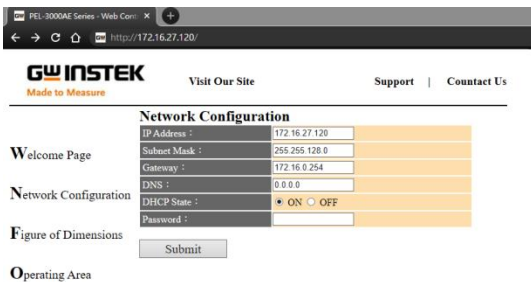

2. You can click the Figure of dimension to see the device dimensions information.

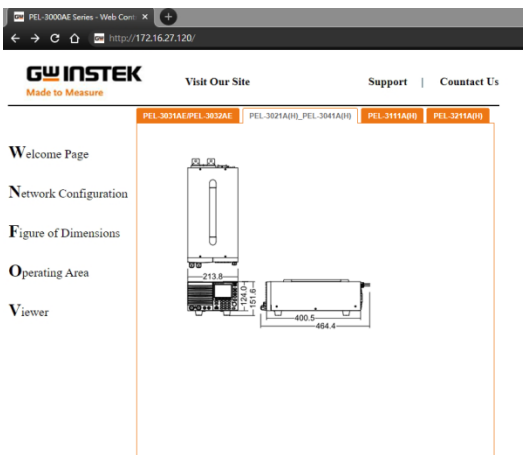

3. You can click the Operating area to see the Load operating area.

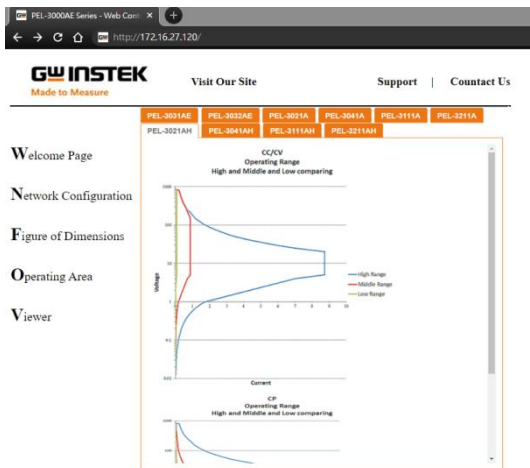

# F AQ

- 
- The load voltage indicated on the load module is below expected.
  - The front panel keys are not working.
  - The load won't turn on.
  - The performance does not match the specification

The load voltage indicated on the load module is below expected.

---

Ensure the load leads are as short as possible, twisted and use the appropriate wire gauge. Ensure that voltage sense is used, this can help alleviate the voltage drop across the load the leads.

The front panel keys are not working.

---

Check to make sure that the key lock has not been activated. LOCK will be shown on the panel when the screen is locked. Press Shift + Lock to unlock the keys.

The load won't turn on.

---

If you are using the load key to try to turn the load on and the load won't turn on, it is possible that external control is activated and that the LoadOn In setting is set to low. See page 198 for details.

The performance does not match the specification.

---

Make sure the device is powered On for at least 30 minutes, within +20°C-+30°C. This is necessary to stabilize the unit to match the specification.

For more information, contact your local dealer or GW Instek at  
[www.gwinstek.com](http://www.gwinstek.com) / [marketing@goodwill.com](mailto:marketing@goodwill.com).



# APPENDIX

---

Replacing the Dust Filter .....	249
Replace the Clock Battery .....	250
GPIB Installation .....	251
PEL-3000A/AH Default Settings .....	252
Frame Control Connector Contacts .....	255
J1 Connector .....	255
J2 Connector .....	257
Monitor Out ports J3 (PEL-3021AH/PEL-3041AH /PEL-3111AH) .....	258
J1 Connector Booster .....	258
J2 Connector Booster .....	259
Operating Mode Description .....	261
CC Mode .....	261
CR Mode .....	262
CP Mode .....	264
CV Mode .....	265
Operating Area .....	266
PEL-3000A Specifications .....	273
Rating (Master / Slave) .....	273
Rating (Booster / Slave) .....	273
CC Mode .....	274
CR Mode .....	275
CV Mode .....	275
CP Mode .....	276
Slew Rate .....	276
Meter .....	277
Dynamic Mode .....	278
Soft Start .....	280
Remote Sensing .....	280
Protection Function .....	280
Sequence .....	281
Other .....	281
Analog External Control .....	282

Front Panel BNC Connector .....	283
General.....	283
<b>PEL-3000AH Specifications .....</b>	<b>285</b>
Rating (Master / Slave) .....	285
Rating (Booster / Slave).....	285
CC Mode .....	286
CR Mode.....	287
CV Mode .....	287
CP Mode.....	288
Slew Rate .....	288
Meter .....	289
Dynamic Mode .....	290
Soft Start .....	292
Remote Sensing.....	292
Protection Function.....	293
Sequence .....	293
Other .....	294
Analog External Control.....	294
Front Panel BNC Connector .....	295
General.....	296
<b>PEL-3000A/AH Dimensions .....</b>	<b>297</b>
PEL-3111A .....	297
PEL-3021A, PEL-3041A.....	298
PEL-3211A .....	299
<b>Certificate Of Compliance .....</b>	<b>300</b>

## Replacing the Dust Filter

---

**Background** The dust filter should be replaced twice a year. Not replacing the filter will reduce performance and may cause the PEL-3000A/AH to malfunction.

---

- Procedure**
1. Turn the PEL-3000A/AH off completely at the rear panel power switch.
  2. Gently lift the grill up from the bottom.

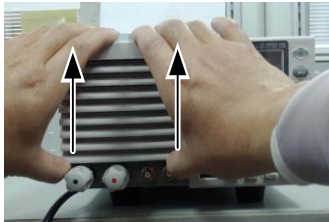

3. Remove the filter from the grill and replace with GW Instek part number: PEL-010.

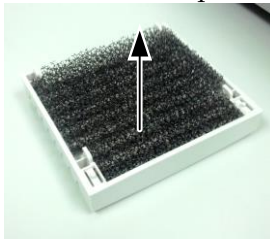

## Replace the Clock Battery

---

### Background

The system clock keeps time using a user-replaceable battery.

The battery should be replaced approximately every 3 years.

---

Battery type: CR2032

---

### Procedure

1. Turn off the PEL-3000A/AH and remove the case.
  - First remove the handle by carefully removing the plastic tabs and then unscrewing the two screws connecting the handle to the case.
  - A total of 10 screws should be removed from the case.
2. Remove the battery and replace with the same type and rating.
  - The battery is located on the right hand side, near the rear panel.

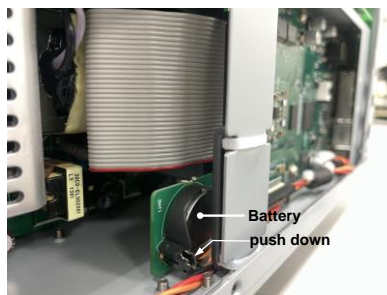

## GPIB Installation

---

**Background** GPIB is an optional extra. The following instructions describe how to install the optional GPIB card if necessary.

---

- Procedure**
1. Turn off the PEL-3000A/AH.
  2. Remove the two screws holding the cover on the option bay.
  3. Slide the GPIB card onto the rails in the option bay.
  4. Re-screw the screws back into place.
- 

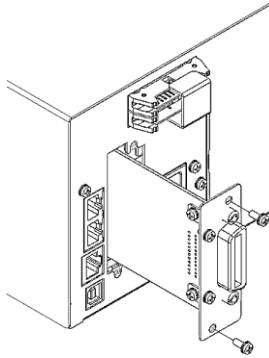

## PEL-3000A/AH Default Settings

The following default settings are the factory configuration settings for the PEL-3000A/AH.

### Main Settings

Item	Panel Settings	Setup Memory Settings (all 100 sets)
Current(CC)	0 A	0 A
Conductance(CR)	0 S	0 S
Voltage(CV)	Maximum value	Maximum value
Wattage(CP)	0 W	0 W
+CV	OFF	OFF
Current range	H	H
Voltage range	150 V/800 V	150 V/800 V
Load on/off	Load off	Load off
Operation mode	CC	CC
Slew rate	Maximum value of H range	Maximum value of H range
Preset memories	Settings above in each mode	Settings above in each mode

### Main > Configure > Protection

Item	Panel Settings	Setup Memory Settings (all 100 sets)
OCP Level	Maximum value	Maximum value
OCP Setting	LIMIT	LIMIT
OPP Level	Maximum value	Maximum value
OPP Setting	LIMIT	LIMIT
UVP value	OFF	OFF
OVP value	OFF	OFF

### Main > Configure > Other

Item	Panel Settings	Setup Memory Settings (all 100 sets)
Soft Start	OFF	OFF
Von Voltage	0.00V	0.00V
Von Latch	ON	ON
Von Delay	2.0 ms	2.0 ms
Von Delay-CR	5.0 ms	5.0 ms
Short Key	Toggle	Toggle

Count Time(elapsed time display)	OFF	OFF
Cut Off Time	OFF	OFF
Response	1/1	1/1
Mem.Recall	Safety	Safety
Dyna. Level	Value	Value
Dyna. Time	T1/T2	T1/T2
CR Unit	mS	mS

## Main &gt; Configure &gt; Go-NoGo

Item	Panel Settings	Setup Memory Settings (all 100 sets)
SPEC. Test	OFF	OFF
Delay Time	0.0s	0.0s
Entry Mode	Value	Value
High	Maximum Voltage / Maximum Current	Maximum Voltage / Maximum Current
Low	Minimum Voltage / Minimum Voltage	Minimum Voltage / Minimum Voltage

## Main &gt; Configure &gt; Next Menu &gt; Parallel

Item	Panel Settings	Setup Memory Settings (all 100 sets)
Operation	Master Auto	Master
Parallel	OFF	OFF
Booster	OFF	OFF

## Main &gt; Configure &gt; Next Menu &gt; Knob

Item	Panel Settings	Setup Memory Settings (all 100 sets)
Status	Step	Step
CCH Step	Resolution	Resolution
CCM Step	Resolution	Resolution
CCL Step	Resolution	Resolution
CRH Step	Resolution	Resolution
CRM Step	Resolution	Resolution
CRL Step	Resolution	Resolution
CVH Step	Resolution	Resolution
CVL Step	Resolution	Resolution
CPH Step	Resolution	Resolution
CPM Step	Resolution	Resolution
CPL Step	Resolution	Resolution

---

**Main > Configure > Next Menu > External**

---

Item	Panel Settings	Setup Memory Settings (all 100 sets)
Control	OFF	OFF
+CV Control	OFF	OFF
LoadOn IN	OFF	OFF
Sync-Mode	OFF	OFF



## Frame Control Connector Contacts

### J1 Connector

Pin name	Pin number	Description
EXT R/V CONT	1	Used for voltage/resistance control of CC, CR, CV and CP mode.  0V to 10V corresponds to 0% to 100% of the rated current (CC mode), rated voltage (CV mode), or rated power (CP mode). 0V to 10V corresponds to the maximum resistance to minimum resistance (CR mode)  0Ω to 10kΩ corresponds to 0% to 100% or 100% to 0% of the rated current (CC mode), rated voltage (CV mode), or rated power (CP mode). 0Ω to 10kΩ corresponds to maximum resistance to minimum resistance or minimum resistance to maximum resistance (CR mode)
IMON (Ext-V In (+) for +CV)	2	Current monitor output 10 V f.s (H/L range) and 1 V f.s (M range) Used for voltage control of Cx+CV mode (For PEL-3000AH series only). 0V to 10V corresponds to 0% to 100% of the rated voltage.
A COM	3	Connected to the negative load input terminal on the rear panel.
SUM I MON	4	Used during master/slave operation. Connected to SUM I MON of the J2 connector.
PRL IN+	5	Used during master/slave operation. Connected to PRL OUT+ of the J2 connector.
PRL IN-	6	Used during master/slave operation. Connected to PRL OUT- of the J2 connector.
LOAD ON/OFF CONT	7	Turns on the load with low (or high) TTL level signal. Pulled up the internal circuit to 5 V using 10 kΩ.

RANGE CONT 1	8	External range switch input*1 *2
RANGE CONT 0	9	Pulled up the internal circuit to 5 V using 10 kΩ.
ALARM INPUT	10	Activates alarm with low TTL level signal input. Pulled up the internal circuit to 5 V using 10 kΩ.
TRIG INPUT	11	An active high TTL pulse of 10μs or more is required. Pulled down the internal circuit to A COM using approx. 100 kΩ.
A COM	12	Connected to the negative load input terminal on the rear panel.
LOAD ON STATUS	13	Turns on when load is on. Open collector output by a photocoupler.*4
RANGE STATUS 1	14	Range status output*3. Open collector output by a photocoupler.*4
RANGE STATUS 0	15	
ALARM STATUS	16	Turns on when an alarm (OVP, OCP, OPP, OTP, RVP, or UVP) is activated or when an external alarm is applied. Open collector output by a photocoupler.*4
STATUS COM	17	STATUS signal common for pins 13 to 16.
RESERVED	18	RESERVED.
SHORT SIGNAL OUT	19	Relay contact output (30 VDC/1 A)
SHORT SIGNAL OUT	20	

\*1 Valid only when the front panel settings are H range.

*2	RANGE CONT 0	RANGE CONT 1
H range	1	1
M range	1	0
L range	0	1

*3	RANGE STATUS 0	RANGE STATUS 1
H range	OFF	OFF
M range	OFF	ON
L range	ON	OFF

\*4 The maximum applied voltage of the photocoupler is 30 V; the maximum current is 8 mA.

## J2 Connector

Pin name	Pin number	Description
N.C.	1	Not connected.
N.C.	2	Not connected.
N.C.	3	Not connected.
SUM I MON	4	Connect to SUM I MON of the J1 connector.
PRL OUT+	5	Used during master/slave operation. Connected to PRL IN+ of the J1 connector.
PRL OUT-	6	Used during master/slave operation. Connected to PRL IN- of the J1 connector.
LOAD ON/OFF CONT	7	Turns on the load with low (or high) TTL level signal. Pulled up the internal circuit to 5V using 10 k $\Omega$ .
N.C.	8	Not connected.
SLAVE RANGE CONT	9	Used during master/slave operation. Connected to RANGE CONT 0 of the J1 connector.
N.C.	10	Not connected.
N.C.	11	Not connected.
A COM	12	Connected to the negative load input terminal on the rear panel.
N.C.	13	Not connected.
N.C.	14	Not connected.
N.C.	15	Not connected.
ALARM INPUT	16	Activates an alarm with high (or low) TTL level signal input. Pulled up the internal circuit to 5 V.
A COM	17	Connected to the negative load input terminal.
N.C.	18	Not connected.
A COM	19	Connected the negative load input terminal.
+15V	20	Controls the on/off of the load booster power (cannot be used for multiple purposes).

## Monitor Out ports J3

(PEL-3021AH/PEL-3041AH/PEL-3111AH)

Pin name	Pin number	Description
I MON	1	Current monitor output 10V f.s (H/L range) and 1V f.s (M range)
V MON	2	Voltage monitor output 10V f.s
A COM	3	Connected to the negative load input terminal.
A COM	4	Connected to the negative load input terminal.

## J1 Connector Booster

Pin name	Pin number	Description
N.C.	1	Not connected.
N.C.	2	Not connected.
A COM	3	Connected to the negative load input terminal.
SUM I MON	4	Connected to SUM I MON of the J2 connector.
PRL IN+	5	Connected to PRL OUT+ of the J2 connector.
PRL IN-	6	Connected to PRL OUT- of the J2 connector.
LOAD ON/OFF CONT	7	Turns on the load with low (or high) TTL level signal.
N.C.	8	Pulled up by the internal circuit to 5 V using 10 k $\Omega$ .
RANGE CONT 0	9	External range switch input <sup>*1 *2</sup> Pulled up the internal circuit to 5 V using 10 k $\Omega$ .
ALARM INPUT	10	Activates an alarm with high (or low) TTL level signal input. Pulled up by the internal circuit to 5 V.
N.C.	11	Not connected.
A COM	12	Connected to the negative load input terminal on the rear panel.
N.C.	13	Not connected.
N.C.	14	Not connected.
N.C.	15	Not connected.
ALARM STATUS	16	Turns on when an alarm (OVP, OCP, OPP, OTP, RVP, or UVP) is activated or when an external alarm is applied. Open collector output by a photocoupler. <sup>*3</sup>
STATUS COM	17	STATUS signal common for pins 16.
N.C.	18	Not connected.

A COM	19	Connected to the negative load input terminal on the rear panel.
+15V	20	Controls the on/off of the load booster power (cannot be used for multiple purposes).

\*1 Valid only when the front panel settings are H range.

\*2 RANGE CONT 0

H range 1

M range 1

L range 0

\*3 The maximum applied voltage of the photocoupler is 30 V; the maximum current is 8 mA.

## J2 Connector Booster

Pin name	Pin number	Description
N.C.	1	Not connected.
N.C.	2	Not connected.
N.C.	3	Not connected.
SUM I MON	4	Connect to SUM I MON of the J1 connector.
PRL OUT+	5	Used during master/slave operation. Connected to PRL IN+ of the J1 connector.
PRL OUT-	6	Used during master/slave operation. Connected to PRL IN- of the J1 connector.
LOAD ON/OFF CONT	7	Turns on the load with low (or high) TTL level signal.
N.C.	8	Not connected.
SLAVE RANGE CONT	9	Used during master/slave operation. Connected to RANGE CONT 0 of the J1 connector.
N.C.	10	Not connected.
N.C.	11	Not connected.
A COM	12	Connected to the negative load input terminal on the rear panel.
N.C.	13	Not connected.
N.C.	14	Not connected.
N.C.	15	Not connected.
ALARM INPUT	16	Activates an alarm with high (or low) TTL level signal input. Pulled up by the internal circuit to 5 V.
A COM	17	Connected to the negative load input terminal.

---

N.C.	18	Not connected.
A COM	19	Connected to the negative load input terminal.
+15V	20	Controls the on/off of the load booster power (cannot be used for multiple purposes).

---

## Operating Mode Description

### CC Mode

---

**CC Mode** When the unit is set to CC mode it will operate as a constant current load when connected to a constant voltage source. This means the unit will sink a designated amount of current, up to the rated power level, regardless of the voltage. This is illustrated below.

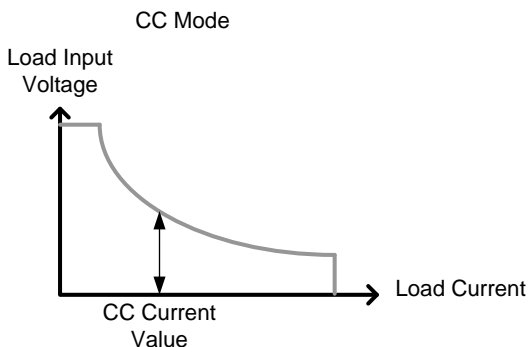

**CC+CV Mode** When CC+CV mode is enabled, the unit will act as constant current load after the input voltage is greater than the user-defined CV level. At the CV level, the unit works as a constant voltage load. This mode effectively creates a voltage ceiling before the unit operates in CC mode. The diagram below illustrates this.

---

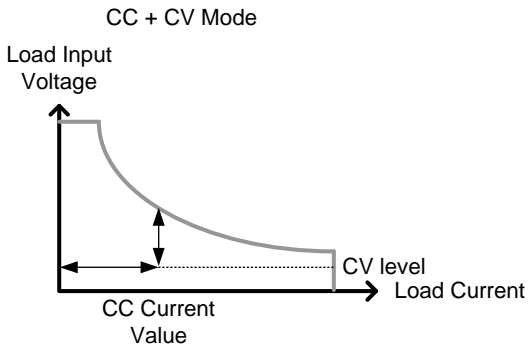

Note

When the source voltage is less than the CV level, no current will flow due to a very high impedance.

## CR Mode

### CR Mode

When the unit is set to CR mode it will operate as a constant resistance load when connected to a constant voltage (CV) or constant current (CC) source. This means the unit will maintain a set resistance, up to the rated power, regardless of the load voltage or current. When input voltage changes, the unit responds by changing the current load to maintain the set resistance according to ohm's law.

CV source : Load current = Load voltage / CR setting value

CC source : Load voltage = Load current x CR setting value

This is illustrated below.

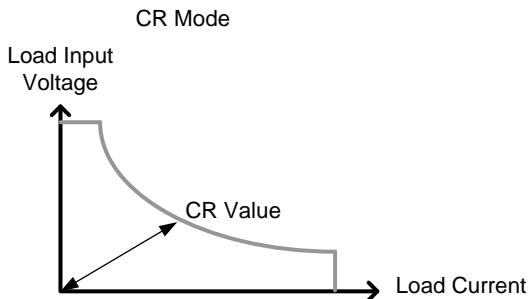

**CR+CV Mode**

When CR+CV mode is enabled, the unit will act as constant resistive load after the input voltage is greater than the user-defined CV level. At the CV level, the unit works as a constant voltage load. This mode effectively creates a voltage ceiling before the unit operates in CR mode. The diagram below illustrates this.

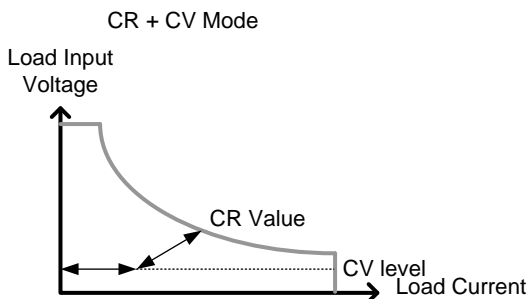
**Note**

When the source voltage is less than the CV level, no current will flow due to a very high impedance.

## CP Mode

---

### CP Mode

When the unit is set to CP mode it will operate as a constant power load when connected to a constant voltage source. This means the unit will maintain a set power level, up to the rated current or voltage level, regardless of the input voltage. When input voltage changes, the unit responds by changing the current load to maintain the set power level accordingly ( $P=I \times V$ ). This is illustrated below.

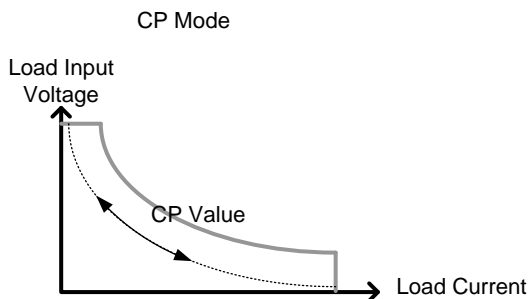

### CP+CV Mode

When CP+CV mode is enabled, the unit will act as a constant power load after the input voltage is greater than the user-defined CV level. At the CV level, the unit works as a constant voltage load. This mode effectively creates a voltage ceiling before the unit operates in CP mode. The diagram below illustrates this.

---

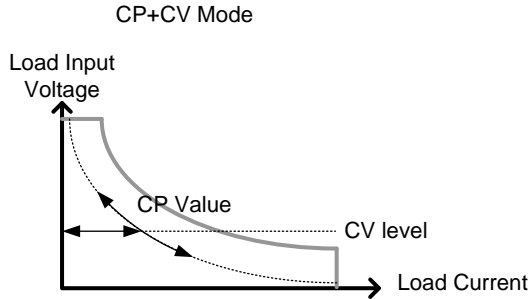

Note

When the source voltage is less than the CV level, no current will flow due to a very high impedance.

## CV Mode

---

### CV Mode

When the unit is set to CV mode it will operate as a constant voltage load when connected to a constant current source. This means the unit will maintain a set voltage level, up to the rated power, regardless of the input current. When the source voltage is less than the CV level, no current will flow due to a very high impedance. This is illustrated below.

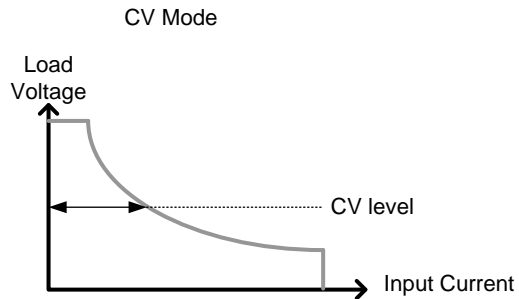

# Operating Area

---

PEL-3021A

High Range Chart

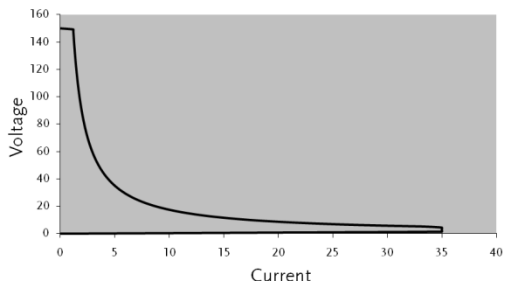

Middle Range Chart

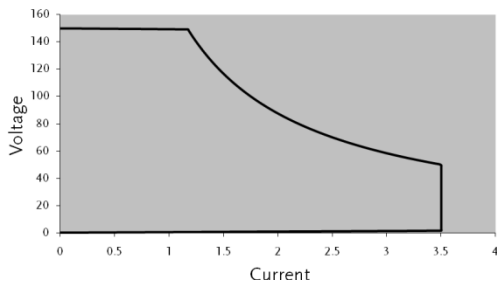

Low Range Chart

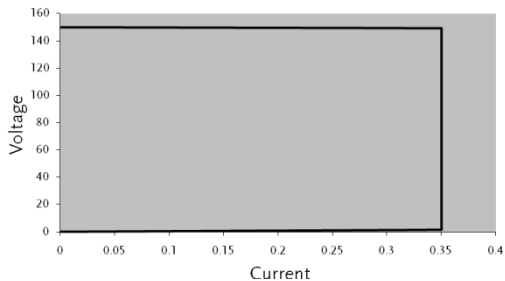

PEL-3041A

High Range Chart

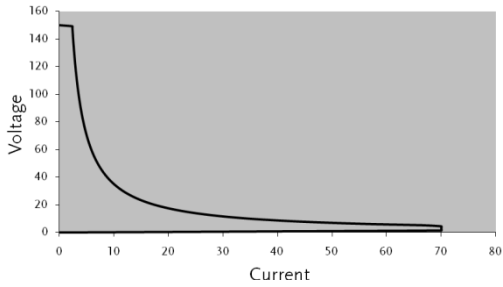

Middle Range Chart

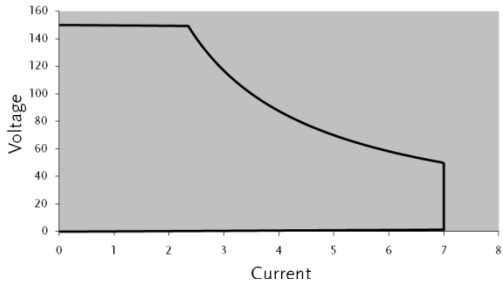

Low Range Chart

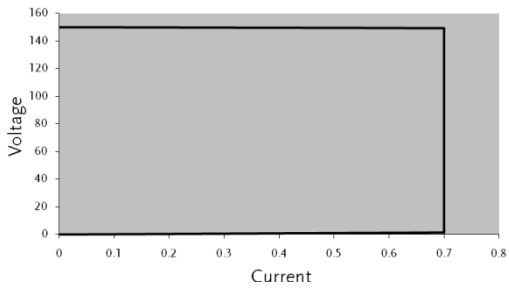

PEL-3111A

High Range Chart

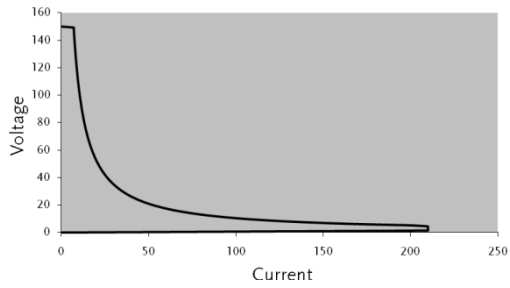

Low Range Chart

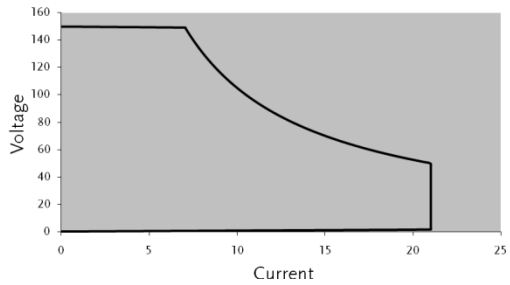

Low Range Chart

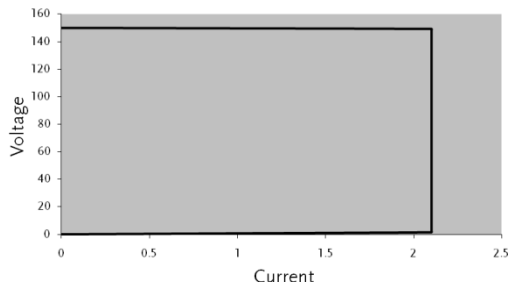

**PEL-3211A  
Booster Pack**

High Range Chart

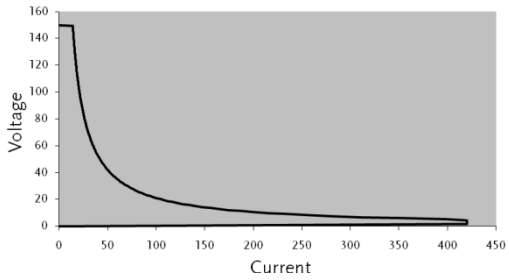

**PEL-3021AH**

High Range Chart

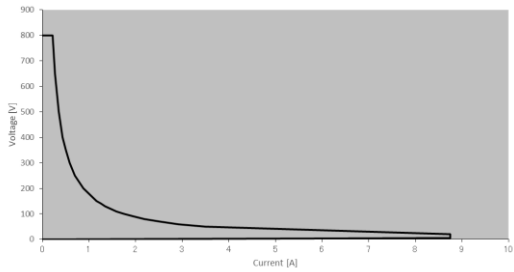

Middle Range Chart

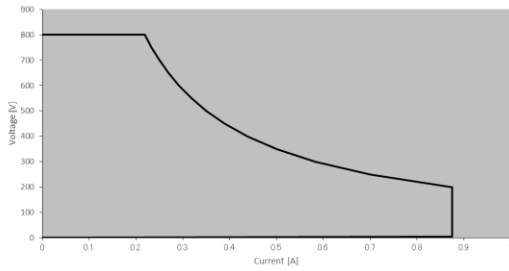

Low Range Chart

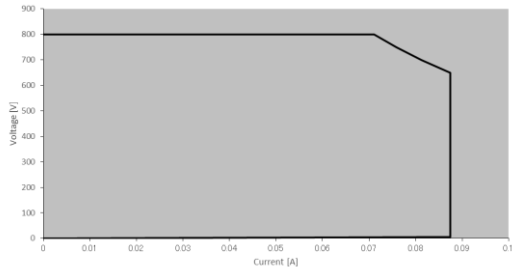

**PEL-3041AH**

High Range Chart

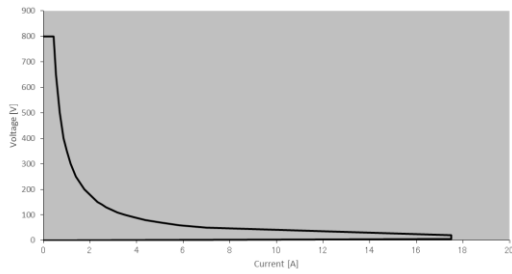

Middle Range Chart

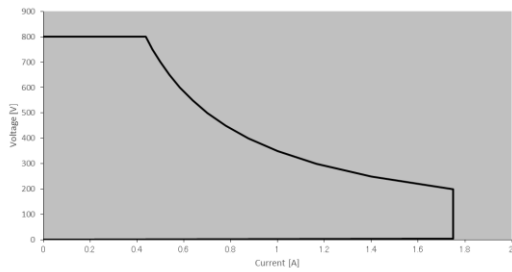

Low Range Chart

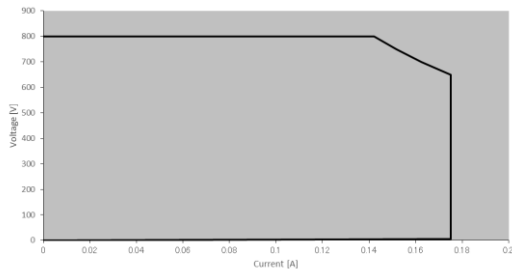



**PEL-3111AH**

High Range Chart

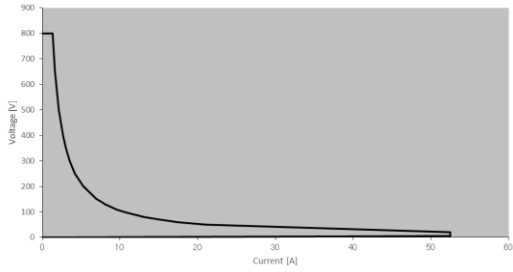

Middle Range Chart

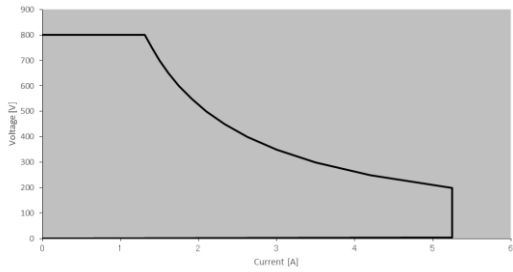

Low Range Chart

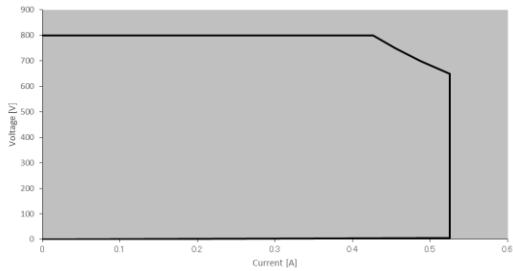

**PEL-3211AH  
Booster Pack**

High Range Chart

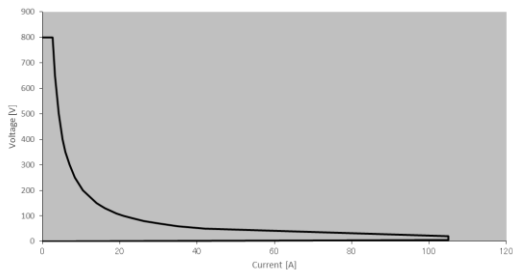

Middle Range Chart

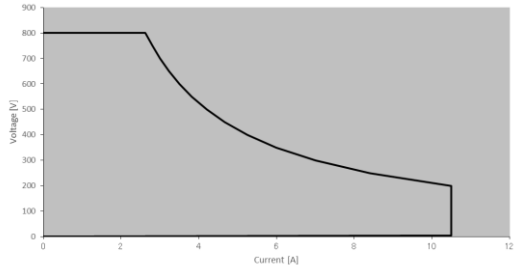

Low Range Chart

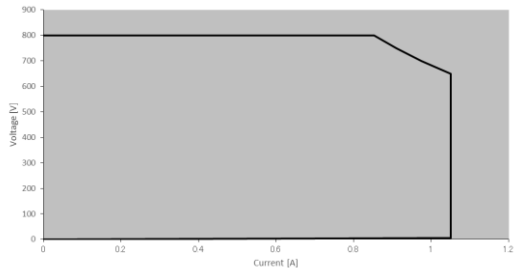

## PEL-3000A Specifications

The specifications apply when the PEL-3000A is powered on for at least 30 minutes to warm-up to a temperature of  $25^{\circ}\text{C} \pm 5^{\circ}\text{C}$ , unless specified otherwise.

All specifications apply when using the rear panel terminals. If the front panel terminals are used or if operating with long cables, remote sense must be connected to the terminals.

In parallel mode: All operation/settings/resolution specifications are N times. This does not include voltage settings and measured values. The maximum slew rate settings also don't change.

N = Number of units in parallel (same model on master)

N = PEL-3111A + 2 x Number of units in parallel (PEL-3211A)

### Rating (Master / Slave)

Model	PEL-3021A	PEL-3041A	PEL-3111A
Voltage	0V-150V		
Current	35A	70A	210A
Min. Operating Voltage	1.5 V at 35A	1.5 V at 70A	1.5 V at 210A
Power	175W	350W	1050W

### Rating (Booster / Slave)

Model	PEL-3211A
Voltage	0V-150V
Current	420A
Min. Operating Voltage	1.5 V at 420A
Power	2100W

**Current Setting Accuracy**

$\pm(1.2\% \text{ of set} + 1.1\% \text{ of f.s})$

M range applies to the full scale of H range.



Note

PEL-3211A only has H or M current ranges.

**CC Mode**

Model	PEL-3021A	PEL-3041A	PEL-3111A
<b>Operating Range</b>			
H Range	0-35A	0-70A	0A-210A
M Range	0-3.5A	0-7A	0A-21A
L Range	0-0.35A	0-0.7A	0A-2.1A
<b>Setting Range</b>			
H Range	0-36.75A	0-73.5A	0-220.5A
M Range	0-3.675A	0-7.35A	0-22.05A
L Range	0-0.3675A	0-0.735A	0-2.205A
<b>Default Setting</b>			
H Range	0A	0A	0A
M Range	0A	0A	0A
L Range	0A	0A	0A
<b>Resolution</b>			
H Range	1mA	2mA	10mA
M Range	0.1mA	0.2mA	1mA
L Range	0.01mA	0.02mA	0.1mA
<b>Accuracy of Setting</b>			
H, M Range	$\pm(0.2\% \text{ of set} + 0.1\% \text{ of f.s}^{*1}) + V_{in}^{*2}/500 \text{ k}\Omega$		
L Range	$\pm(0.2\% \text{ of set} + 0.1\% \text{ of f.s}) + V_{in}^{*2}/500 \text{ k}\Omega$		
Parallel Operation	$\pm(1.2\% \text{ of set} + 1.1\% \text{ of f.s}^{*3})$		
<b>Input Voltage Variation<sup>*4</sup></b>			
H Range	$2\text{mA} + V_{in}^{*2}/500\text{k}\Omega$	$4\text{mA} + V_{in}^{*2}/500\text{k}\Omega$	$10\text{mA} + V_{in}^{*2}/500\text{k}\Omega$
M Range	$2\text{mA} + V_{in}^{*2}/500\text{k}\Omega$	$4\text{mA} + V_{in}^{*2}/500\text{k}\Omega$	$10\text{mA} + V_{in}^{*2}/500\text{k}\Omega$
L Range	$0.1\text{mA} + V_{in}^{*2}/500\text{k}\Omega$	$0.2\text{mA} + V_{in}^{*2}/500\text{k}\Omega$	$0.6\text{mA} + V_{in}^{*2}/500\text{k}\Omega$
<b>Ripple</b>			
RMS <sup>*5</sup>	3mA	5mA	20mA <sup>*7</sup>
P-P <sup>*6</sup>	30mA	50mA	100mA <sup>*7</sup>

\*1 Full scale of H range

\*2  $V_{in}$ : input terminal voltage of electronic load

\*3 M range applies to the full scale of H range

\*4 When the input voltage is varied from 1.5V to 150V at a current of rated power/150V

\*5 Measurement frequency bandwidth: 10Hz to 1MHz

\*6 Measurement frequency bandwidth: 10Hz to 20MHz

\*7 At measurement current of 100A

## CR Mode

Model	PEL-3021A	PEL-3041A	PEL-3111A
<b>Operating Range<sup>*1</sup></b>			
H Range	23.3336S-400 $\mu$ S (42.857m $\Omega$ -2.5k $\Omega$ )	46.6672S-800 $\mu$ S (21.428m $\Omega$ -1.25k $\Omega$ )	140.0016S-2.4mS (7.1427m $\Omega$ -416.6667 $\Omega$ )
M Range	2.33336S-40 $\mu$ S (428.566m $\Omega$ -25k $\Omega$ )	4.6667S-80 $\mu$ S (214.28m $\Omega$ -12.5k $\Omega$ )	14.0001S-242.4 $\mu$ S (71.427m $\Omega$ -4.16667k $\Omega$ )
L Range	0.233336S-4 $\mu$ S (4.28566 $\Omega$ -250k $\Omega$ )	0.46667S-8 $\mu$ S (2.1428 $\Omega$ -125k $\Omega$ )	1.40001S-24.24 $\mu$ S (714.27m $\Omega$ -41.6667k $\Omega$ )
<b>Setting Range</b>			
H Range	24.5S-0S (40.8163 m $\Omega$ -OPEN)	49.0S-0S (20.408 m $\Omega$ -OPEN)	147.000S-0S (6.8027 m $\Omega$ -OPEN)
M Range	2.45S-0S (408.1633m $\Omega$ -OPEN)	4.90S-0S (204.08m $\Omega$ -OPEN)	14.7000S-0S (68.0272m $\Omega$ -OPEN)
L Range	0.245S-0S (4.08163 $\Omega$ -OPEN)	0.490S-0S (2.0408 $\Omega$ -OPEN)	1.4000S-0S (680.2721m $\Omega$ -OPEN)
<b>Resolution</b>			
H Range	400 $\mu$ S	800 $\mu$ S	2.4mS
M Range	40 $\mu$ S	80 $\mu$ S	240 $\mu$ S
L Range	4 $\mu$ S	8 $\mu$ S	24 $\mu$ S
<b>Accuracy of Setting<sup>*2</sup></b>			
H, M Range	$\pm(0.5\% \text{ of set}^{*3} + 0.5\% \text{ of f.s}^{*4}) + \text{Vin}^{*5}/500 \text{ k}\Omega$		
L Range	$\pm(0.5\% \text{ of set}^{*3} + 0.5\% \text{ of f.s}^{*4}) + \text{Vin}^{*5}/500 \text{ k}\Omega$		
Parallel Operation	$\pm(1.2\% \text{ of set} + 1.1\% \text{ f.s}^{*4})$		

\*1 Siemens[S] = Input current[A] / Input voltage[V] = 1 / resistance[ $\Omega$ ]

\*2 Converted value at the input current. At the sensing point during remote sensing under the operating range of the input voltage.

\*3 set = Vin / Rset

\*4 f.s = M range applies to the full scale of H range

\*5 Vin = Input terminal voltage of electronic load

## CV Mode

Model	PEL-3021A	PEL-3041A	PEL-3111A
<b>Operating Range</b>			
H Range	1.5V-150V		
L Range	1.5V-15V		
<b>Setting Range</b>			
H Range	0V-157.5V		
L Range	0V-15.75V		

Resolution	
H Range	10mV
L Range	1mV
Accuracy of Setting*1	
H, L Range	$\pm(0.1\% \text{ of set} + 0.1\% \text{ of f.s})$
Input current variation*2	
H Range	50mV
L Range	12mV

\*1 At the sensing point during remote sensing under the operating range of the input voltage. It is also applied for the condition of the parallel operation.

\*2 With respect to a change in the current of 10 % to 100 % of the rating at an input voltage of 1.5 V (during remote sensing).

### CP Mode

Model	PEL-3021A	PEL-3041A	PEL-3111A
Operating Range			
H Range	17.5W -175W	35W-350W	105W -1050W
M Range	1.75W -17.5W	3.5W-35W	10.5W -105W
L Range	0.175W -1.75W	0.35W-3.5W	1.05W -10.5W
Setting Range			
H Range	0W-183.75W	0W-367.5W	0W-1102.5W
M Range	0W-18.375W	0W-36.75W	0W-110.25W
L Range	0W-1.8375W	0W-3.675W	0W-11.025W
Resolution			
H Range	10mW	10mW	100mW
M Range	1mW	1mW	10mW
L Range	0.1mW	0.1mW	1mW
Accuracy of Setting*1			
$\pm(0.6\% \text{ of set} + 1.4\% \text{ of f.s}^{*2}) + V_{in}^{2*3}/500k\Omega$			

\*1 It is not applied for the condition of the parallel operation.

\*2 M range applies to the full scale of H range.

\*3  $V_{in}$  = Input terminal voltage of electric load.

### Slew Rate

Model	PEL-3021A	PEL-3041A	PEL-3111A
Setting Range (CC Mode)			
H Range	2.5mA/μs-2.5A/μs	5mA/μs-5A/μs	16.02mA/μs-16.002A/μs
M Range	250uA/μs-250mA/μs	500uA/μs-500mA/μs	1.602mA/μs-1.6002A/μs
L Range	25uA/μs-25mA/μs	50μA/μs-50mA/μs	160.2μA/μs-160.02mA/μs

Setting Range (CR Mode)			
H Range	250uA/μs-250mA/μs	500uA/μs-500mA/μs	1.602mA/μs-1.6002A/μs
M Range	25uA/μs-25mA/μs	50uA/μs-50mA/μs	160.2μA/μs-160.02mA/μs
L Range	2.5μA/μs-2.5mA/μs	5uA/μs-5mA/μs	16.02μA/μs-16.002mA/μs
Resolution			
Resolution	1mA	2mA	6mA
Setting	250mA/μs-2.5A/μs	500mA/μs-5A/μs	1.6A/μs-16A/μs
Resolution	100μA	200μA	600μA
Setting	25mA/μs-250mA/μs	50mA/μs-500mA/μs	160mA/μs-1.6A/μs
Resolution	10μA	20μA	60μA
Setting	2.5mA/μs-25mA/μs	5mA/μs-50mA/μs	16mA/μs-160mA/μs
Resolution	1μA	2μA	6μA
Setting	250μA/μs-2.5mA/μs	500uA/μs-5mA/μs	1.6mA/μs-16mA/μs
Resolution	100nA	200nA	600nA
Setting	25μA/μs-250μA/μs	50uA/μs-500μA/μs	160μA/μs-1.6mA/μs
Resolution	10nA	20nA	60nA
Setting	2.5μA/μs-25μA/μs	5μA/μs-50μA/μs	16μA/μs-160μA/μs
Accuracy of Setting*1			
	±(10% of set + 5μs)		

\*1 Time to reach from 10 % to 90 % when the current is varied from 2 % to 100 % (20 % to 100 % in M range) of the rated current.

## Meter

Model	PEL-3021A	PEL-3041A	PEL-3111A
Voltmeter			
H Range	0.00V-150.00V		
L Range	0.000V-15.000V		
Accuracy	±(0.1 % of rdg + 0.1 % of f.s)		
Ammeter			
H Range	0.000A-35.000A	0.000A-70.000A	0.00A-210.00A
M Range	0.0000A-3.5000A	0.0000A-7.0000A	0.000A-21.000A
L Range	0.00mA-350.00mA	0.00mA-700.00mA	0.0mA-2100.0mA
Accuracy	±(0.2 % of rdg + 0.3 % of f.s*1)		
Accuracy	Parallel Operation: ±(1.2% of rdg +1.1% of f.s)		
Wattmeter			
H, M Range	0.00W-175.00W	0.00W-350.00W	0.00W-1050W
L(CC/CR/CV mode)	0.000W-52.500W	0.000W-105.000W	0.00W-315.00W
L(CP mode)	0.0000W- 1.7500W	0.0000W- 3.5000W	0.000W- 10.500W

Temperature Coefficient per °C	
Voltmeter	100ppm
Ammeter	200ppm

\*1 M range applies to the full scale of H range.

## Dynamic Mode

Model	PEL-3021A	PEL-3041A	PEL-3111A
Operating Mode	CC, CR and CP		
T1 & T2	0.025ms - 10ms / Res: 1μs 10ms - 60s / Res: 1ms		
Accuracy	± 100ppm of setting		
Frequency Range (Freq./Duty)	1Hz -20kHz		
Frequency Resolution	1Hz-9.9Hz 0.1Hz 10Hz-99Hz 1Hz 100Hz-990Hz 10Hz 1kHz-20kHz 100Hz		
Frequency Accuracy of Setting	(0.5% of set)		
Duty Cycle of Setting (Freq./Duty)	1% -99% , 0.1% step		
The minimum time width is 10μs. Between 1kHz and 20kHz, the maximum duty cycle is limited by the minimum time width.			
Slew Rate Setting Range (CC Mode)			
H Range	2.5mA/μs-2.5A/μs	5mA/μs-5A/μs	16.mA/μs-16.A/μs
M Range	250uA/μs-250mA/μs	500uA/μs-500mA/μs	1.6mA/μs-1.6A/μs
L Range	25uA/μs-25mA/μs	50uA/μs-50mA/μs	160uA/μs-160mA/μs
Slew Rate Setting Range (CR Mode)			
H Range	250uA/μs-250mA/μs	500uA/μs-500mA/μs	1.6mA/μs-1.6A/μs
M Range	25uA/μs-25mA/μs	50uA/μs-50mA/μs	160uA/μs-160mA/μs
L Range	2.5uA/μs-2.5mA/μs	5uA/μs-5mA/μs	16uA/μs-16mA/μs
Slew Rate Resolution			
Resolution	1mA	2mA	6mA
Setting	250mA/μs-2.5A/μs	500mA/μs-5A/μs	1.6A/μs-16A/μs
Resolution	100μA	200μA	600μA
Setting	25mA/μs -250mA/μs	50mA/μs-500mA/μs	160mA/μs-1.6A/μs
Resolution	10μA	20μA	60μA



Setting	2.5mA/μs -25mA/μs	5mA/μs-50mA/μs	16mA/μs-160mA/μs
Resolution	1μA	2μA	6μA
Setting	250uA/μs-2.5mA/μs	500uA/μs -5mA/μs	1.6mA/μs -16mA/μs
Resolution	100nA	200nA	600nA
Setting	25μA/μs-250μA/μs	50uA/μs-500uA/μs	160μA/μs -1.6mA/μs
Resolution	10nA	20nA	60nA
Setting	2.5μA/μs-25μA/μs	5μA/μs-50uA/μs	16μA/μs-160μA/μs
Slew Rate Accuracy of Setting*1			
±(10% of set + 25μs)			

\*1 Time to reach from 10 % to 90 % when the current is varied from 2 % to 100 % (20 % to 100 % in M range) of the rated current.

Current Setting Range			
H Range	0-35.7A	0-71.4A	0-214.2A
M Range	0-3.57A	0-7.14A	0-21.42A
L Range	0-0.357A	0-0.714A	0-2.142A
Current Resolution			
H Range	1mA	2mA	10mA
M Range	0.1mA	0.2mA	1mA
L Range	0.01mA	0.02mA	0.1mA
Current Accuracy			
±0.4% F.S			

Resistance Setting Range			
H Range	24.5S-0S (40.8163 mΩ-OPEN)	49.0S-0S (20.408 mΩ-OPEN)	147.000S-0S (6.8027 mΩ-OPEN)
M Range	2.45S-0S (408.1633mΩ-OPEN)	4.90S-0S (204.08mΩ-OPEN)	14.70000S-0S (68.0272mΩ-OPEN)
L Range	0.245S-0S (4.08163Ω-OPEN)	0.490S-0S (2.0408Ω-OPEN)	1.4000S-0S (680.2721mΩ-OPEN)

Resistance Resolution			
H Range	400μS	800μS	2.4mS
M Range	40μS	80μS	240μS
L Range	4μS	8μS	24μS

Resistance Accuracy of setting (R set(S) > 0.03% of f.s)			
H, M Range	±(0.5 % of set*1 + 0.5 % of f.s*2) + Vin*3/500 kΩ		
L Range	±(0.5 % of set*1 + 0.5 % of f.s) + Vin*3/500 kΩ		

\*1 set = Vin / Rset

\*2 f.s = Full scale of High Range

\*3 Vin = Input terminal voltage of Electronic Load

Power Operating Range			
H Range	17.5W -175W	35W-350W	105W-1050W
M Range	1.75W-17.5W	3.5W-35W	10.5W-105W
L Range	0.175W-1.75W	0.35W-3.5W	1.05W-10.5W

Setting Range			
H Range	0W-183.75W	0W-367.5W	0W-1102.5W
M Range	0W-18.375W	0W-36.75W	0W-110.25W
L Range	0W-1.8375W	0W-3.675W	0W-11.025W
Resolution			
H Range	10mW	10mW	100mW
M Range	1mW	1mW	10mW
L Range	0.1mW	0.1mW	1mW
Accuracy of Setting*1			
$\pm(0.6 \% \text{ of set} + 1.4 \% \text{ of f.s}^{*2}) + V_{in}^{2*3}/500k\Omega$			

\*1 It is not applied for the condition of the parallel operation.

\*2 M range applies to the full scale of H range.

\*3  $V_{in}$  = Input terminal voltage of electronic load.

## Soft Start

Operation Mode	
CC, CR and CP	
Selectable Time Range	
1- 200 ms/Res: 1ms	
Time Accuracy	
$\pm(30\% \text{ of set} + 100\mu\text{s})$	

## Remote Sensing

Voltage that can be Compensated	
2V for a single line	

## Protection Function

Model	PEL-3021A	PEL-3041A	PEL-3111A
Overvoltage protection(OVP)			
Turns off the load at 110% of the rated voltage			
Overcurrent protection(OCP)			
0.03-38.5A		0.06A-77A	0.2A-231A
or 110% of the maximum current of each range			
Load off or limit selectable			
Overpower protection(OPP)			
0.1W - 192.5W		0.1W - 385W	1W - 1155W
or 110% of the maximum power of each range			
Load off or limit selectable			

<b>Overheat protection(OTP)</b>	Turns off the load when the heat sink temperature reaches 105 °C (PEL-3211:115°C)
<b>Undervoltage protection(UVP)</b>	Turns off the load when detected. Can be set in the H range of 0.01V to 165V or Off. Can be set in the L range of 0.001V to 16.5V or Off.
<b>Reverse voltage protection(RVP)</b>	By diode. Turns off the load when an alarm occurs.
<b>Rating overcurrent protection (ROCP)</b>	An ROCP message will be produced when the input current range is greater than 110% of the rated operating current range (I range).
<b>Rating overpower protection (ROPP)</b>	An ROPP message will be produced when the input power range is greater than 110% of the rated operating power range.
<b>Front panel input rating overcurrent protection (F.ROCP)</b>	An F.ROCP message will be produced when the front panel input current range is greater than 77A (Typical).

## Sequence

<b>Normal Sequence</b>	
Operation mode	CC, CR, CV or CP
Maximum number of steps	1000
Step Execution Time	0.05ms – 999 h 59 min
Time resolution	0.05 ms (0.05 ms – 1 min)/100 ms (1 min – 1 h)/1 s (1 h – 10 h)/10 s (10 h – 100 h)/1 min (100 h – 999 h 59 min)
<b>Fast Sequence</b>	
Operation mode	CC or CR
Maximum number of steps	1000
Step Execution Time	25 μs – 600 ms
Time resolution	1 μs (25μs -60ms) /10μs (60.01ms -600ms)

## Other

<b>Elapsed Time Delay</b>	Measures the time from load on to load off. On/Off selectable. Measures from 1 s up to 999 h 59 min 59 s
<b>Auto Load Off Timer</b>	Automatically turns off the load after a specified time elapses. Can be set in the range of 1 s to 999 h 59 min 59 s or off

Communication Function	
GPIB	IEEE std. 488.1-1978 (partial support) SH1, AH1, T6, L4, SR1, DC1, DT1. Supports the SCPI and IEEE std. 488.2-1992 command set Sets panel functions except the power switch and reads measured values
RS-232 /RS-485	RJ-45 connector, Complies with the EIA-RS-232/RS-485 specifications (excluding the connector) Sets panel functions except the power switch and reads measured values Supports the SCPI and IEEE std. 488.2-1992 command set Baud rate: 2400, 4800, 9600, 19200, 38400 bps Data length: 8-bit, Stop bit: 1, 2-bit, Parity bit: None, Odd, Even.
LAN	MAC Address, DNS IP Address, User Password, Gateway IP Address, Instrument IP Address, Subnet Mask
USB	Conforms to USB 2.0 Specifications and USB-CDC ACM Sets panel functions except the power switch and reads measured values Communication speed 12 Mbps (Full speed)

## Analog External Control

Load on/off Control Input	Turn on the load with low (or high) TTL level signal
Load on Status Output	On when the load is on (open collector output by a photocoupler)
Range Switch Input	Switch ranges L, M, and H using a 2-bit signal
Range Status Output	Outputs range L, M, or H using 2-bit signal (open collector output by a photocoupler)
Trigger Input	Clear the sequence operation pause with a high TTL level signal for 10 $\mu$ s or more.
Alarm Input	Activate alarm with low TTL level signal input
Alarm Status Output	On when OVP, OCP, OPP, OTP, UVP, RVP, or when an external alarm input is applied (open collector output by a photocoupler)
Short Signal Output	Relay contact output (30 VDC/1 A)

**External Voltage Control**

Operates in CC, CR, CP, or CV mode

0 V to 10 V correspond to 0 % to 100 % of the rated current (CC mode), rated voltage (CV mode), or rated power (CP mode).

0 V to 10 V correspond to maximum resistance to minimum resistance (CR mode)

**External Resistance Control**

Operates in CC, CR, CP, or CV mode

0  $\Omega$  to 10 k $\Omega$  correspond to 0 % to 100 % or 100 % to 0 % of the rated current (CC mode), rated voltage (CV mode), or rated power (CP mode).

0  $\Omega$  to 10 k $\Omega$  correspond to maximum resistance to minimum resistance or minimum resistance to maximum resistance (CR mode)

**Current Monitor Output**

10 V f.s (H or L range) and 1 V f.s (M range)

**Parallel Operation Input**

Signal input for one-control parallel operation

**Parallel Operation Output**

Signal output for one-control parallel operation

**Load Boost Power Supply Control**

Power on/off control signal for the load booster

**Front Panel BNC Connector****TRIG OUT**

Trigger output: Approx. 5V pulse width: Approx. 2.5 $\mu$ s, output impedance: Approx. 500 $\Omega$

Outputs a pulse during sequence operation and switching operation.

**I MON OUT**

Current monitor output

1V f.s (H or L range) and 0.1V f.s (M range)

**Accuracy**

H Range 0.5%setting+0.5%F.S.

M Range 0.7%setting+1%F.S.

L Range 0.5%setting+0.5%F.S.

## General

Model	PEL-3021A	PEL-3041A	PEL-3111A	PEL-3211A
Input Range	The rated voltage is 100-120VAC/200-240VAC and the maximum input voltage is 90-132VAC/180-250VAC.			
Inrush Frequency	47~63Hz			
Power (max)	90VA	110VA	190VA	230VA
Inrush Current	45A Max			
Input Resistance (Load OFF)	500kΩ			
Insulation Resistance	Primary to input terminal: 500 VDC, 20MΩ or more. Primary to chassis: 500 VDC, 20MΩ or more. Input terminal to chassis: 500 VDC, 20MΩ or more.			
Withstand Voltage	Primary to input terminal: No abnormalities at 1500 VAC for 1 minute. Primary to chassis: No abnormalities at 1500 VAC for 1 minute. Input terminal to chassis: No abnormalities at 1500 VAC for 1 minute.			
Dimensions (mm)	213.8(W) x124(H) x400.5(D)	213.8(W) x124(H) x400.5(D)	427.8(W) x124(H) x400.5(D)	427.7(W) x127.8(H) x553.5(D)
Weight	Maximum    Approx.6kg    Approx.7kg    Approx. 17kg    Approx. 23kg			

## PEL-3000AH Specifications

The specifications apply when the PEL-3000AH is powered on for at least 30 minutes to warm-up to a temperature of  $25^{\circ}\text{C} \pm 5^{\circ}\text{C}$ , unless specified otherwise.

All specifications apply when using the rear panel terminals. If the front panel terminals are used or if operating with long cables, remote sense must be connected to the terminals.

In parallel mode: All operation/settings/resolution specifications are N times. This does not include voltage settings and measured values. The maximum slew rate settings also don't change.

N = Number of units in parallel (same model on master)

N = PEL-3111AH + 2 x Number of units in parallel (PEL-3211AH)

### Rating (Master / Slave)

Model	PEL-3021AH	PEL-3041AH	PEL-3111AH
Operating Voltage	0V~800V	0V~800V	0V~800V
Current	8.75A	17.5A	52.5A
Min. Operating Voltage	5V at 8.75A	5V at 17.5A	5V at 52.5A
Power	175W	350W	1050W

### Rating (Booster / Slave)

Model	PEL-3211AH
Operating Voltage	0V~800V
Current	105A
Min. Operating Voltage	5V at 105A
Power	2100W
Current Setting Accuracy	$\pm(1.2\% \text{ of set} + 1.1\% \text{ of f.s})$ M range applies to the full scale of H range.

## CC Mode

Model	PEL-3021AH	PEL-3041AH	PEL-3111AH
<b>Operating Range</b>			
H Range	0-8.75A	0-17.5A	0-52.5A
M Range	0-875mA	0-1.75A	0-5.25A
L Range	0-87.5mA	0-175mA	0-525mA
<b>Setting Range</b>			
H Range	0-9.1875A	0-18.375A	0-55.126A
M Range	0-918.75mA	0-1.8375A	0-5.5126A
L Range	0-91.875mA	0-183.75mA	0-0.55126A
<b>Default Setting</b>			
H Range	0A	0A	0A
M Range	0A	0A	0A
L Range	0A	0A	0A
<b>Resolution</b>			
H Range	0.3mA	0.6mA	2mA
M Range	0.03mA	0.06mA	0.2mA
L Range	0.003mA	0.006mA	0.02mA
<b>Accuracy of Setting</b>			
H, M Range	$\pm(0.2\% \text{ of set} + 0.1\% \text{ of f.s}^{*1}) + V_{in}^{*2}/3.24M\Omega$		
L Range	$\pm(0.2\% \text{ of set} + 0.1\% \text{ of f.s}) + V_{in}^{*2}/3.24M\Omega$		
Parallel Operation	$\pm(1.2\% \text{ of set} + 1.1\% \text{ of f.s}^{*3})$		
<b>Input Voltage Variation<sup>*4</sup></b>			
H Range	$20mA + V_{in}^{*2}/3.24M\Omega$	$20mA + V_{in}^{*2}/3.24M\Omega$	$20mA + V_{in}^{*2}/3.24M\Omega$
M Range	$20mA + V_{in}^{*2}/3.24M\Omega$	$20mA + V_{in}^{*2}/3.24M\Omega$	$20mA + V_{in}^{*2}/3.24M\Omega$
L Range	$2mA + V_{in}^{*2}/3.24M\Omega$	$2mA + V_{in}^{*2}/3.24M\Omega$	$2mA + V_{in}^{*2}/3.24M\Omega$
<b>Ripple</b>			
RMS <sup>*5</sup>	2mA	4mA	12mA
P-P <sup>*6</sup>	20mA	40mA	120mA

\*1 Full scale of H range

\*2  $V_{in}$ : input terminal voltage of electronic load

\*3 M range applies to the full scale of H range

\*4 When the input voltage is varied from 5V to 800V at a current of rated power/800V

\*5 Measurement frequency bandwidth: 10Hz to 1MHz

\*6 Measurement frequency bandwidth: 10Hz to 20MHz



## CR Mode

Model	PEL-3021AH	PEL-3041AH	PEL-3111AH
<b>Operating Range<sup>*1</sup></b>			
H Range	1.75S~30 $\mu$ S (571m $\Omega$ ~33.3k $\Omega$ )	3.5S~60 $\mu$ S (285m $\Omega$ ~16.6k $\Omega$ )	10.5S~180 $\mu$ S (95.2m $\Omega$ ~5.55k $\Omega$ )
M Range	175mS~3 $\mu$ S (5.71 $\Omega$ ~333k $\Omega$ )	350mS~6 $\mu$ S (2.85 $\Omega$ ~166k $\Omega$ )	1.05S~18 $\mu$ S (952m $\Omega$ ~55.5k $\Omega$ )
L Range	17.5mS~0.3 $\mu$ S (57.1 $\Omega$ ~3.33M $\Omega$ )	35mS~0.6 $\mu$ S (28.5 $\Omega$ ~1.66M $\Omega$ )	105mS~1.8 $\mu$ S (9.52 $\Omega$ ~555k $\Omega$ )
<b>Setting Range</b>			
H Range	1837.5mS~0mS (0.54422 $\Omega$ ~OPEN)	3675mS~0mS (0.27211 $\Omega$ ~OPEN)	11025mS~0mS (0.09070 $\Omega$ ~OPEN)
M Range	183.75mS~0mS (5.44218 $\Omega$ ~OPEN)	367.5mS~0mS (2.72109 $\Omega$ ~OPEN)	1102.5mS~0mS (0.90703 $\Omega$ ~OPEN)
L Range	18.375mS~0S (54.4218 $\Omega$ ~OPEN)	36.75mS~0mS (27.2109 $\Omega$ ~OPEN)	110.25mS~0mS (9.07029 $\Omega$ ~OPEN)
<b>Resolution</b>			
H Range	30 $\mu$ S	60 $\mu$ S	180 $\mu$ S
M Range	3 $\mu$ S	6 $\mu$ S	18 $\mu$ S
L Range	0.3 $\mu$ S	0.6 $\mu$ S	1.8 $\mu$ S
<b>Accuracy of Setting<sup>*2</sup></b>			
H, M Range	$\pm(0.5\% \text{ of set}^{*3} + 0.5\% \text{ of f.s}^{*4}) + \text{Vin}^{*5}/3.24\text{M}\Omega$		
L Range	$\pm(0.5\% \text{ of set}^{*3} + 0.5\% \text{ of f.s}) + \text{Vin}^{*5}/3.24\text{M}\Omega$		
Parallel Operation	$\pm(1.2\% \text{ of set} + 1.1\% \text{ f.s}^{*4})$		

\*1 Siemens[S] = Input current[A] / Input voltage[V] = 1 / resistance[ $\Omega$ ]

\*2 Converted value at the input current. At the sensing point during remote sensing under the operating range of the input voltage.

\*3 set = Vin / Rset

\*4 f.s = M range applies to the full scale of H range

\*5 Vin = Input terminal voltage of electronic load

## CV Mode

Model	PEL-3021AH	PEL-3041AH	PEL-3111AH
<b>Operating Range</b>			
H Range	5V~800V		
L Range	5V~80V		
<b>Setting Range</b>			
H Range	0V~840V		
L Range	0V~84V		

Resolution	
H Range	20mV
L Range	2mV
Accuracy of Setting <sup>*1</sup>	
H, L Range	$\pm(0.2\% \text{ of set} + 0.2\% \text{ of f.s})$
Input current variation <sup>*2</sup>	
H Range	80mV
L Range	80mV

<sup>\*1</sup> At the sensing point during remote sensing under the operating range of the input voltage. It is also applied for the condition of the parallel operation.

<sup>\*2</sup> With respect to a change in the current of 10 % to 100 % of the rating at an input voltage of 5V (during remote sensing).

## CP Mode

Model	PEL-3021AH	PEL-3041AH	PEL-3111AH
Operating Range			
H Range	17.5W -175W	35W-350W	105W -1050W
M Range	1.75W -17.5W	3.5W-35W	10.5W -105W
L Range	0.175W -1.75W	0.35W-3.5W	1.05W -10.5W
Setting Range			
H Range	0W-183.75W	0W-367.5W	0W-1102.5W
M Range	0W-18.375W	0W-36.75W	0W-110.25W
L Range	0W-1.8375W	0W-3.675W	0W-11.025W
Resolution			
H Range	10mW	10mW	100mW
M Range	1mW	1mW	10mW
L Range	0.1mW	0.1mW	1mW
Accuracy of Setting <sup>*1</sup>			
$\pm(0.6\% \text{ of set} + 1.4\% \text{ of f.s}^{*2}) + V_{in}^{2*3}/3.24M\Omega$			

<sup>\*1</sup> It is not applied for the condition of the parallel operation.

<sup>\*2</sup> M range applies to the full scale of H range.

<sup>\*3</sup>  $V_{in}$  = Input terminal voltage of electric load.

## Slew Rate

Model	PEL-3021AH	PEL-3041AH	PEL-3111AH
Setting Range (CC Mode)			
H Range	0.1400mA/ $\mu$ s ~ 140.0mA/ $\mu$ s	0.280mA/ $\mu$ s ~ 280.0mA/ $\mu$ s	0.840mA/ $\mu$ s ~ 840.0mA/ $\mu$ s

M Range	0.01400mA/μs ~ 14.000mA/μs	0.0280mA/μs ~ 28.00mA/μs	0.0840mA/μs~ 84.00mA/μs
L Range	1.400μA/μs ~ 1400.0μA/μs	2.80μA/μs ~ 2800μA/μs	0.00840mA/μs ~ 8.400mA/μs
<b>Setting Range (CR Mode)</b>			
H Range	0.01400mA/μs ~ 14.000mA/μs	0.0280mA/μs ~ 28.00mA/μs	0.0840mA/μs~ 84.00mA/μs
M Range	0.001400mA/μs ~ 1.4000mA/μs	0.00280mA/μs ~ 2.800mA/μs	0.00840mA/μs ~ 8.400mA/μs
L Range	0.1400μA/μs ~ 140.00μA/μs	0.280μA/μs ~ 280.0μA/μs	0.000840mA/μs ~ 0.8400mA/μs
<b>Resolution</b>			
Resolution	50μA	100μA	300μA
Setting	14mA/μs ~140mA/μs	28mA/μs ~280mA/μs	84 mA/μs ~840mA/μs
Resolution	5μA	10μA	30μA
Setting	1.4mA/μs ~14mA/μs	2.8mA/μs ~28mA/μs	8.4 mA/μs ~84mA/μs
Resolution	0.5μA	1μA	3μA
Setting	140μA/μs ~1.4mA/μs	280μA/μs ~2.8mA/μs	840μA/μs ~8.4mA/μs
Resolution	50nA	0.1μA	0.3μA
Setting	14μA/μs ~140μA/μs	28μA/μs ~280μA/μs	84μA/μs ~840μA/μs
Resolution	5nA	10nA	30nA
Setting	1.4μA/μs ~14μA/μs	2.8μA/μs ~28μA/μs	8.4μA/μs ~84μA/μs
Resolution	0.5nA	1nA	3nA
Setting	0.14 μA/μs ~1.4μA/μs	0.28μA/μs ~2.8μA/μs	0.84μA/μs ~8.4μA/μs
<b>Accuracy of Setting<sup>*1</sup></b>			
±(10% of set + 25μs)			

<sup>\*1</sup> Time to reach from 10 % to 90 % when the current is varied from 2 % to 100 % (20 % to 100 % in M range) of the rated current.

## Meter

Model	PEL-3021AH	PEL-3041AH	PEL-3111AH
<b>Voltmeter</b>			
H Range	0.00V ~ 800.00V		
L Range	0.000V ~ 80.000V		
Accuracy	±(0.1 % of rdg + 0.1 % of f.s)		
<b>Ammeter</b>			
H Range	0.000A-8.7500A	0.000A-17.500A	0.00A-52.500A
M Range	0.0000A-875.00mA	0.0000A-1.7500A	0.000A-5.2500A
L Range	0.00mA-87.500mA	0.00mA-175.00mA	0.0mA-525.00mA
Accuracy	±(0.2 % of rdg + 0.3 % of f.s <sup>*1</sup> )		
Accuracy	Parallel Operation: ±(1.2% of rdg +1.1% of f.s)		

<b>Wattmeter</b>			
H, M Range	0.00W-175.00W	0.00W-350.00W	0.00W-1050W
L(CC/CR/ CV mode)	0.000W-56.875W	0.000W-113.75W	0.00W-341.25W
L(CP mode)	0.0000W- 1.7500W	0.0000W- 3.5000W	0.000W- 10.500W
<b>Temperature Coefficient per °C</b>			
Voltmeter	100ppm		
Ammeter	200ppm		

\*1 M range applies to the full scale of H range.

## Dynamic Mode

<b>Model</b>	PEL-3021AH	PEL-3041AH	PEL-3111AH
<b>Operating Mode</b>			
	CC, CR and CP		
<b>T1 &amp; T2</b>			
	0.025ms - 10ms/ Res: 1µs; 10ms - 60s/ Res: 1ms		
<b>Accuracy</b>			
	± 100ppm of setting		
<b>Frequency Range (Freq./Duty)</b>			
	1Hz -20kHz		
<b>Frequency Resolution</b>			
1Hz-9.9Hz	0.1Hz		
10Hz-99Hz	1Hz		
100Hz-990Hz	10Hz		
1kHz-20kHz	100Hz		
<b>Frequency Accuracy of Setting</b>			
	(0.5% of set)		
<b>Duty Cycle of Setting (Freq./Duty)</b>			
	1% -99% , 0.1% step		
The minimum time width is 10µs. Between 1kHz and 20kHz, the maximum duty cycle is limited by the minimum time width.			
<b>Slew Rate Setting Range (CC Mode)</b>			
H Range	0.1400mA/µs ~ 140.0mA/µs	0.280mA/µs ~ 280.0mA/µs	0.840mA/µs ~ 840.0mA/µs
M Range	0.01400mA/µs ~ 14.000mA/µs	0.0280mA/µs ~ 28.00mA/µs	0.0840mA/µs~ 84.00mA/µs
L Range	1.400µA/µs ~ 1400.0µA/µs	2.80µA/µs ~ 2800µA/µs	0.00840mA/µs ~ 8.400mA/µs
<b>Slew Rate Setting Range (CR Mode)</b>			
H Range	0.01400mA/µs ~ 14.000mA/µs	0.0280mA/µs ~ 28.00mA/µs	0.0840mA/µs~ 84.00mA/µs

M Range	0.001400mA/μs ~ 1.4000mA/μs	0.00280mA/μs ~ 2.800mA/μs	0.00840m/μs ~ 8.400mA/μs
L Range	0.1400μA/μs ~ 140.00μA/μs	0.280μA/μs ~ 280.0μA/μs	0.000840mA/μs~ 0.8400mA/μs
<b>Slew Rate Resolution</b>			
Resolution	50μA	100μA	300μA
Setting	14mA~140mA/μs	28mA~280mA/μs	84mA~840mA/μs
Resolution	5μA	10μA	30μA
Setting	1.4mA~14mA/μs	2.8mA~28mA/μs	8.4mA~84mA/μs
Resolution	0.5μA	1μA	3μA
Setting	140μA~1.4mA/μs	280μA~2.8mA/μs	840μA~8.4mA/μs
Resolution	50nA	0.1μA	0.3μA
Setting	14μA~140μA/μs	28μA~280μA/μs	84μA~840μA/μs
Resolution	5nA	10nA	30nA
Setting	1.4μA~14μA/μs	2.8μA~28μA/μs	8.4μA~84μA/μs
Resolution	0.5nA	1nA	3nA
Setting	0.14μA~1.4μA/μs	0.28μA~2.8μA/μs	0.84μA~8.4μA/μs
<b>Slew Rate Accuracy of Setting*1</b>			
±(10% of set + 25μs)			

\*1 Time to reach from 10 % to 90 % when the current is varied from 2 % to 100 % (20 % to 100 % in M range) of the rated current.

<b>Current Setting Range</b>			
H Range	0-9.1875A	0-18.375A	0-55.126A
M Range	0-918.75mA	0-1.8375A	0-5.5126A
L Range	0-91.875mA	0-183.75mA	0-0.55126A
<b>Current Resolution</b>			
H Range	0.3mA	0.6mA	2mA
M Range	0.03mA	0.06mA	0.2mA
L Range	0.003mA	0.006mA	0.02mA
<b>Current Accuracy</b>			
±0.4% F.S			
<b>Resistance Setting Range</b>			
H Range	1837.50mS~0mS (0.54422Ω~OPEN)	3675.00mS~0mS (0.27211Ω~OPEN)	11025.0mS~0mS (0.09070Ω~OPEN)
M Range	183.750mS~0mS (5.44218Ω~OPEN)	367.500mS~0mS (2.72109Ω~OPEN)	1102.50mS~0mS (0.90703Ω~OPEN)
L Range	18.3750mS~0mS (54.4218Ω~OPEN)	36.7500mS~0mS (27.2109Ω~OPEN)	110.250mS~0mS (9.07029Ω~OPEN)
<b>Resistance Resolution</b>			
H Range	30μS	60μS	180μS
M Range	3μS	6μS	18μS
L Range	0.3μS	0.6μS	1.8μS

<b>Resistance Accuracy of setting (R set(S) &gt; 0.03% of f.s)</b>			
H, M Range	$\pm(0.5 \% \text{ of set}^{*1} + 0.5 \% \text{ of f.s}^{*2}) + \text{Vin}^{*3}/3.24\text{M}\Omega$		
L Range	$\pm(0.5 \% \text{ of set}^{*1} + 0.5 \% \text{ of f.s}) + \text{Vin}^{*3}/3.24\text{M}\Omega$		
*1 set = Vin / Rset			
*2 f.s = Full scale of High Range			
*3 Vin = Input terminal voltage of Electronic Load			
<b>Power Operating Range</b>			
H Range	17.5W -175W	35W-350W	105W-1050W
M Range	1.75W-17.5W	3.5W-35W	10.5W-105W
L Range	0.175W-1.75W	0.35W-3.5W	1.05W-10.5W
<b>Setting Range</b>			
H Range	0W-183.75W	0W-367.5W	0W-1102.5W
M Range	0W-18.375W	0W-36.75W	0W-110.25W
L Range	0W-1.8375W	0W-3.675W	0W-11.025W
<b>Resolution</b>			
H Range	10mW	10mW	100mW
M Range	1mW	1mW	10mW
L Range	0.1mW	0.1mW	1mW
<b>Accuracy of Setting<sup>*1</sup></b>			
$\pm(0.6 \% \text{ of set} + 1.4 \% \text{ of f.s}^{*2}) + \text{Vin}^{*3}/3.24\text{M}\Omega$			

\*1 It is not applied for the condition of the parallel operation.

\*2 M range applies to the full scale of H range.

\*3 Vin = Input terminal voltage of electronic load.

## Soft Start

<b>Operation Mode</b>	CC and CR
<b>Selectable Time Range</b>	3- 200 ms/Res: 1ms
<b>Time Accuracy</b>	$\pm(30\% \text{ of set} + 100\mu\text{s})$

## Remote Sensing

<b>Voltage that can be Compensated</b>	2V for a single line
--	----------------------

## Protection Function

Model	PEL-3021AH	PEL-3041AH	PEL-3111H
<b>Overvoltage protection(OVP)</b>			
Turns off the load at 110% of the rated voltage			
<b>Overcurrent protection(OCP)</b>			
0.0060A-9.6252A    0.0120A-19.2504A    0.050A-57.750A			
or 110% of the maximum current of each range			
Load off or limit selectable			
<b>Overpower protection(OPP)</b>			
0.1W - 192.5W    0.1W - 385W    1W - 1155W			
or 110% of the maximum power of each range			
Load off or limit selectable			
<b>Overheat protection(OTP)</b>			
Turns off the load when the heat sink temperature reaches 105 °C (PEL-3211H:115°C)			
<b>Under voltage protection(UVP)</b>			
Turns off the load when detected. Can be set in the H range of 0.1V to 840V or Off. Can be set in the L range of 0.01V to 84V or Off.			
<b>Reverse voltage protection(RVP)</b>			
By diode. Turns off the load when an alarm occurs.			
<b>Rating overcurrent protection (ROCP)</b>			
An ROCP message will be produced when the input current range is greater than 110% of the rated operating current range (I range).			
<b>Rating overpower protection (ROPP)</b>			
An ROPP message will be produced when the input power range is greater than 110% of the rated operating power range.			
<b>Front panel input rating overcurrent protection (F.ROCP)</b>			
An F.ROCP message will be produced when the front panel input current range is greater than 77A (Typical).			

## Sequence

<b>Normal Sequence</b>	
Operation mode	CC, CR, CV or CP
Maximum number of steps	1000
Step Execution Time	0.05ms – 999 h 59 min
Time resolution	0.05 ms (0.05 ms – 1 min)/100 ms (1 min – 1 h)/1s (1 h – 10 h)/10s (10 h – 100 h)/1 min (100 h – 999 h 59 min)

<b>Fast Sequence</b>	
Operation mode	CC or CR
Maximum number of steps	1000
Step Execution Time	25 $\mu$ s – 600 ms
Time resolution	1 $\mu$ s(25 $\mu$ s -60ms) /10 $\mu$ s(60.01ms -600ms)

## Other

<b>Elapsed Time Delay</b>	
	Measures the time from load on to load off. On/Off selectable. Measures from 1 s up to 999 h 59 min 59 s
<b>Auto Load Off Timer</b>	
	Automatically turns off the load after a specified time elapses. Can be set in the range of 1 s to 999 h 59 min 59 s or off
<b>Communication Function</b>	
GPIB	IEEE std. 488.1-1978 (partial support) SH1, AH1, T6, L4, SR1, DC1, DT1. Supports the SCPI and IEEE std. 488.2-1992 command set Sets panel functions except the power switch and reads measured values
RS-232 /RS-485	RJ-45 connector, Complies with the EIA-RS-232/RS-485 specifications (excluding the connector) Sets panel functions except the power switch and reads measured values Supports the SCPI and IEEE std. 488.2-1992 command set Baud rate: 2400, 4800, 9600, 19200, 38400 bps Data length: 8-bit, Stop bit: 1, 2-bit, Parity bit: None, Odd, Even.
LAN	MAC Address, DNS IP Address, User Password, Gateway IP Address, Instrument IP Address, Subnet Mask
USB	Conforms to USB 2.0 Specifications and USB-CDC ACM Sets panel functions except the power switch and reads measured values Communication speed 12 Mbps (Full speed)

## Analog External Control

<b>Load on/off Control Input</b>	
	Turn on the load with low (or high) TTL level signal
<b>Load on Status Output</b>	
	On when the load is on (open collector output by a photocoupler)
<b>Range Switch Input</b>	
	Switch ranges L, M, and H using a 2-bit signal



Range Status Output	Outputs range L, M, or H using 2-bit signal (open collector output by a photocoupler)
Trigger Input	Clear the sequence operation pause with a high TTL level signal for 10 $\mu$ s or more.
Alarm Input	Activate alarm with low TTL level signal input
Alarm Status Output	On when OVP, OCP, OPP, OTP, UVP, RVP, or when an external alarm input is applied (open collector output by a photocoupler)
Short Signal Output	Relay contact output (30 VDC/1 A)
External Voltage Control	Operates in CC, CR, CV, CP, or Cx+CV mode 0 V to 10 V correspond to 0 % to 100 % of the rated current (CC mode), rated voltage (CV, Cx+CV mode), or rated power (CP mode). 0 V to 10 V correspond to maximum resistance to minimum resistance (CR mode)
External Resistance Control	Operates in CC, CR, CP, or CV mode 0 $\Omega$ to 10 k $\Omega$ correspond to 0 % to 100 % or 100 % to 0 % of the rated current (CC mode), rated voltage (CV mode), or rated power (CP mode). 0 $\Omega$ to 10 k $\Omega$ correspond to maximum resistance to minimum resistance or minimum resistance to maximum resistance (CR mode)
Current Monitor Output	10 V f.s (H or L range) and 1 V f.s (M range)
Parallel Operation Input	Signal input for one-control parallel operation
Parallel Operation Output	Signal output for one-control parallel operation
Load Boost Power Supply Control	Power on/off control signal for the load booster

## Front Panel BNC Connector

TRIG OUT	Trigger output: Approx. 5V pulse width: Approx. 2.5 $\mu$ s, output impedance: Approx. 500 $\Omega$
----------	---

	Outputs a pulse during sequence operation and switching operation.
<b>I MON OUT</b>	
	Current monitor output 10V f.s (H or L range) and 1V f.s (M range)
<b>Accuracy</b>	
H Range	0.5%setting+0.5%F.S.
M Range	0.7%setting+1%F.S.
L Range	0.5%setting+0.5%F.S.
<b>V MON OUT</b>	
	Voltage monitor output 8V f.s
<b>Accuracy</b>	
H Range	0.5%setting+0.5%F.S.
L Range	0.5%setting+0.5%F.S.

## General

Model	PEL-3021AH	PEL-3041AH	PEL-3111AH	PEL-3211AH
<b>Input Range</b>	The rated voltage is 100-120VAC/200-240VAC and the maximum input voltage is 90-132VAC/180-250VAC.			
<b>Inrush Frequency</b>	47~63Hz			
<b>Power (max)</b>	90VA	110VA	190VA	230VA
<b>Inrush Current</b>	45A Max			
<b>Input Resistance (Load OFF)</b>	3.24MΩ			
<b>Insulation Resistance</b>	Primary to input terminal: 1000 VDC, 20MΩ or more. Primary to chassis: 1000 VDC, 20MΩ or more.			
<b>Withstand Voltage</b>	Primary to input terminal: No abnormalities at 1500 VAC for 1 minute. Primary to chassis: No abnormalities at 1500 VAC for 1 minute.			
<b>Dimensions(mm)</b>	213.8(W) x124(H) x400.5(D)	213.8(W) x124(H) x400.5(D)	427.8(W) x124(H) x400.5(D)	427.7(W) x127.8(H) x553.5(D)
<b>Weight</b>	Maximum    Approx. 9kg    Approx. 10kg    Approx. 20kg    Approx. 28kg			

# PEL-3000A/AH Dimensions

PEL-3111A

---

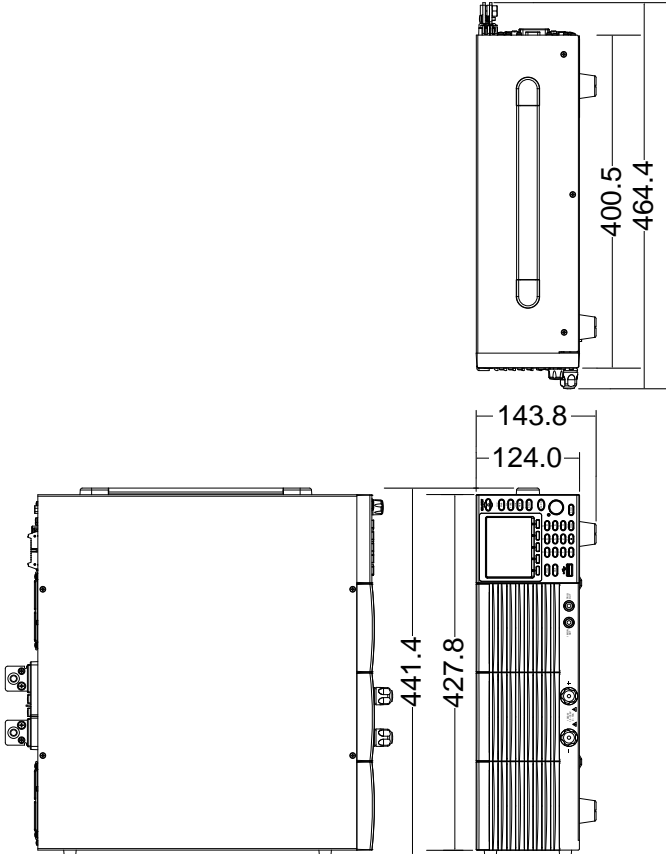

PEL-3021A, PEL-3041A

---

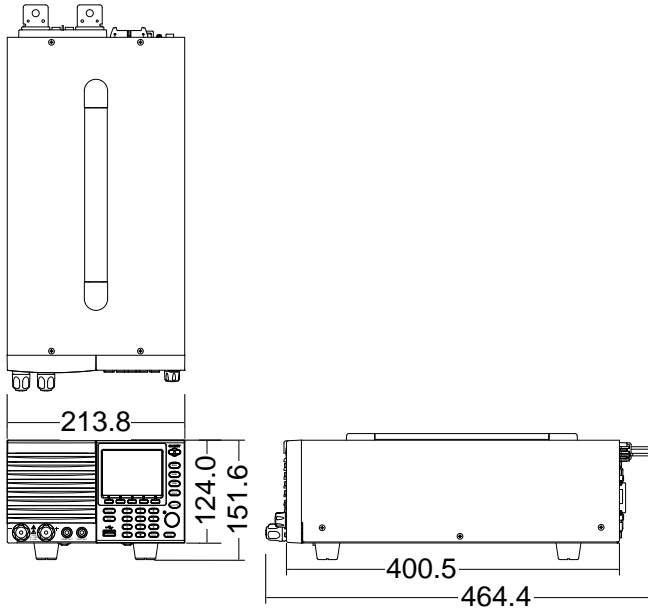

**PEL-3211A**

---

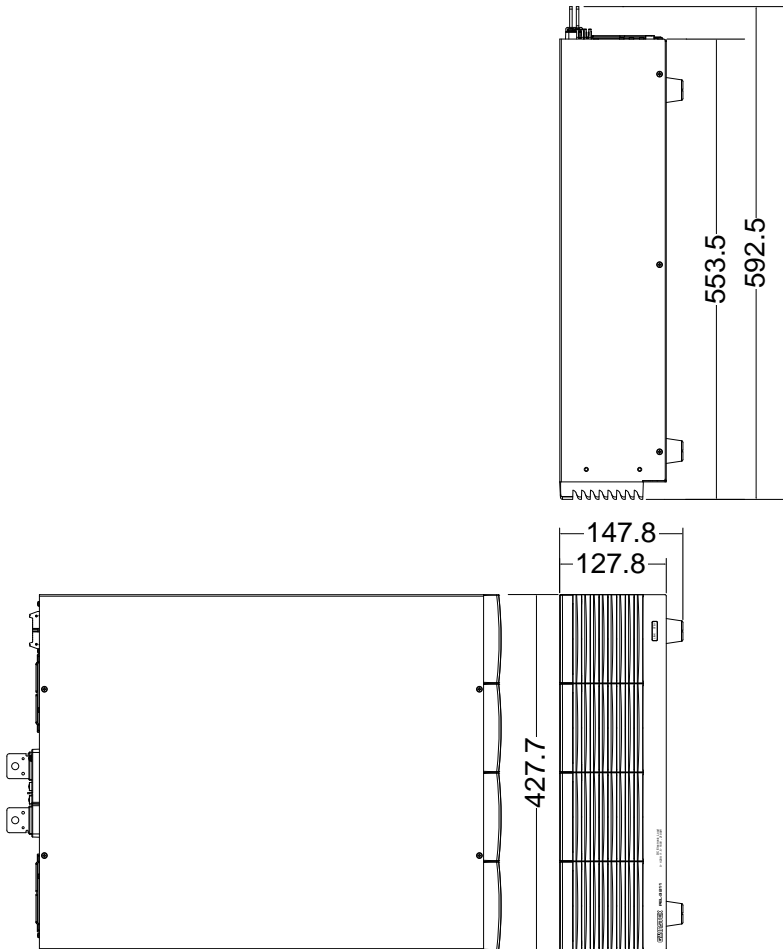

## Certificate Of Compliance

We

**GOOD WILL INSTRUMENT CO., LTD.**

declare that the CE marking mentioned product

satisfies all the technical relations application to the product within the scope of council:

Directive: EMC; LVD; WEEE; RoHS

The product is in conformity with the following standards or other normative documents:

© EMC	
EN 61326-1	Electrical equipment for measurement, control and laboratory use -- EMC requirements
Conducted & Radiated Emission EN 55011 / EN 55032	Electrical Fast Transients EN 61000-4-4
Current Harmonics EN 61000-3-2 / EN 61000-3-12	Surge Immunity EN 61000-4-5
Voltage Fluctuations EN 61000-3-3 / EN 61000-3-11	Conducted Susceptibility EN 61000-4-6
Electrostatic Discharge EN 61000-4-2	Power Frequency Magnetic Field EN 61000-4-8
Radiated Immunity EN 61000-4-3	Voltage Dip/ Interruption EN 61000-4-11 / EN 61000-4-34
© Safety	
EN 61010-1 :	Safety requirements for electrical equipment for measurement, control, and laboratory use - Part 1: General requirements

**GOODWILL INSTRUMENT CO., LTD.**

No. 7-1, Jhongsing Road, Tucheng District, New Taipei City 236, Taiwan

Tel: [+886-2-2268-0389](tel:+886-2-2268-0389)

Fax: [+886-2-2268-0639](tel:+886-2-2268-0639)

Web: <http://www.gwinstek.com> Email: [marketing@goodwill.com.tw](mailto:marketing@goodwill.com.tw)

**GOODWILL INSTRUMENT (SUZHOU) CO., LTD.**

No. 521, Zhujiang Road, Snd, Suzhou Jiangsu 215011, China

Tel: [+86-512-6661-7177](tel:+86-512-6661-7177)

Fax: [+86-512-6661-7277](tel:+86-512-6661-7277)

Web: <http://www.instek.com.cn> Email: [marketing@instek.com.cn](mailto:marketing@instek.com.cn)

**GOODWILL INSTRUMENT EURO B.V.**

De Run 5427A, 5504DG Veldhoven, The Netherlands

Tel: [+31-\(0\)40-2557790](tel:+31-(0)40-2557790)

Fax: [+31-\(0\)40-2541194](tel:+31-(0)40-2541194)

Email: [sales@gw-instek.eu](mailto:sales@gw-instek.eu)

# INDEX

Accessories .....	13	Declaration of conformity .....	300
Advanced configuration		Default settings .....	252
Alarm tone.....	95	operation.....	115
Auto Load.....	80	User.....	115
Control settings.....	96	Display diagram.....	26
Count time.....	78	Disposal instructions .....	8
Cut off time .....	79	Disposal symbol.....	4
Display.....	95	Dynamic mode frequency.....	71
Dyna. Time.....	71	EN61010	
Go-NoGo.....	100	Pollution degree .....	8
Language .....	96	Environment	
Load Off (Mode).....	81	Safety instruction .....	8
Load Off (Range) .....	81	Ethernet	
OCP.....	85	sockets .....	233
OPP .....	86	External control	
OVP.....	90	Alarm.....	203
Protection settings .....	85	Alarm status .....	204
Short enable/disable .....	67	Current monitor .....	206, 207, 208
Short(safety) .....	65	Current status.....	202
Soft start.....	75	Load status.....	201
Speaker .....	94	Overview.....	186
Step resolution.....	82	Resistance control .....	194
System settings .....	94	Short control .....	204
Trigger .....	97	Trigger .....	203
UVP.....	87	Trigger signal output.....	205
Von delay.....	78	Turning the load on.....	199
Von latch.....	77	Voltage control .....	188
Von voltage .....	76	External control.....	185
Alarm Tone.....	95	FAQ.....	245
Analog connector		Fast Sequence	
pin assignment.....	186, 187	Configuration .....	145
Baud rate configuration .....	233	Data edit.....	146
Caution symbol.....	3	Overview.....	141
CC Response speed .....	74	Run .....	148
Cleaning the instrument .....	8	File Utility .....	112
Conventions .....	47	Firmware update.....	45
CP Response speed.....	74	First time use instructions.....	27
CR Response speed .....	74	Front panel diagram .....	16
CV Response rate.....	73		

Function	PEL-3211AH.....	271
Count Time .....	121	
Load .....	119	
Ring Time.....	120	
Select.....	117	
Go_NoGo Tone.....	95	
GPIB installation.....	251	
Ground		
Symbol.....	3	
Help.....	52	
Input terminals		
Front.....	37	
Rear.....	38	
Terminal cover.....	39, 42, 43	
PEL-013 .....	41	
Interface configuration		
Baud Rate .....	233	
RS232 .....	233	
Knob configuration		
Cursor .....	82	
Step .....	83	
Load default settings.....	30	
Load wiring.....	34	
Connection.....	36	
Main features .....	12	
Mainframe operation		
OCP test automation.....	150, 157, 164, 172, 176, 177, 182	
Marketing		
Contact.....	246	
Memory Recall		
safety setting.....	112	
Monitor signal output.....	205	
Normal Sequence		
Configuration .....	135	
Data edit .....	137	
Overview.....	131, 132	
Run.....	138	
OCP alarm.....	85	
OCP test automation.....	150, 157, 164, 172, 176, 177, 182	
Operating area		
PEL-3021A.....	266	
PEL-3021AH .....	269	
PEL-3041A.....	267	
PEL-3041AH .....	270	
PEL-3111A.....	268	
PEL-3111AH .....	271	
PEL-3211A.....	269	
Operating mode		
CC .....	261	
CC+CV .....	261	
CP .....	264	
CP+CV .....	264	
CR.....	262	
CR+CV .....	263	
CV .....	265	
Operation.....	56	
+CV mode.....	63	
CC mode .....	56	
CC Response speed .....	74	
CP mode.....	61	
CP Response speed.....	74	
CR mode .....	58	
CR Response speed.....	74	
CR units .....	59	
CV mode.....	60	
CV Response rate.....	73	
Dynamic mode.....	68	
Dynamic mode units .....	70	
panel lock.....	67	
Short key.....	64	
Short key configuration.....	66	
Slew rate.....	72	
Staticmode .....	68	
Turning the load on.....	64	
OPP alarm.....	86	
OVP alarm .....	90	
Package contents.....	15	
Parallel error.....	92, 93	
Parallel operation		
Capacity .....	209, 210	
Capacity with boosters.....	210, 211	
Configuration .....	213	
Connection.....	211	
Disable.....	215	
Overview .....	209	
Turning the load on.....	215	
Power supply		
Safety instruction .....	7	
Power up.....	30	
Preset.....	114	
Presets		
Save/Recall.....	114	
Program		
Chain.....	128, 140	



Configuration.....	122, 125, 131, 141
Overview .....	123
Run .....	129
Rack mount installation .....	27
Rear panel diagram .....	21
Remote control .....	216
Ethernet function check .....	242
GPIB configuration.....	217
local bus configuration .....	223
multi-unit configuration .....	223
multi-unit function check .....	224
RS232C configuration .....	219, 220
sockets configuration .....	233
sockets function check .....	236
UART configuration.....	221
USB configuration .....	217
Remote control function check	226
GPIB .....	230
Realterm.....	227
Remote sense .....	44
Replace the clock battery .....	250
Replace the dust filter .....	249
Restore default settings.....	114
RS232 configuration .....	233
Safety short .....	65
Save/Recall.....	103
File types.....	104
Presets .....	114
Recall from memory .....	109
Recall from USB .....	110
Recall Safety.....	112
Save to internal memory .....	105
Save to USB.....	107
Sequence.....	131
Service operation	
About disassembly .....	5
Contact .....	246
Setting the date and time .....	31
Short enable/disable .....	67
Socket server function check ..	236
Specifications	
Dimensions .....	297
Frequency.....	273, 285
PEL-3211A .....	273
PEL-3211AH.....	285
Trigger .....	97
UnReg alarm.....	91
Unreg Tone .....	95
USB remote interface connection	217
UVP alarm.....	87
UVP alarm time.....	88
Warning symbol.....	3
Web server function check.....	242
Wire gauge.....	33
Theory .....	34