

# Multiplex Scanner Box

GSB-01/GSB-02

---

## USER MANUAL

GW INSTEK PART NO. 82SB-02000EA1



ISO-9001 CERTIFIED MANUFACTURER

**GW INSTEK**

This manual contains proprietary information, which is protected by copyright. All rights are reserved. No part of this manual may be photocopied, reproduced or translated to another language without prior written consent of Good Will company.

The information in this manual was correct at the time of printing. However, Good Will continues to improve products and reserves the rights to change specification, equipment, and maintenance procedures at any time without notice.

**Good Will Instrument Co., Ltd.**  
**No. 7-1, Jhongsing Rd., Tucheng Dist., New Taipei City 236, Taiwan.**

# Table of Contents

<b>S</b>	<b>SAFETY INSTRUCTIONS .....</b>	<b>4</b>
<b>G</b>	<b>GETTING STARTED .....</b>	<b>9</b>
	GSB-01 and GSB-02 Overview .....	10
	Appearance .....	13
	Safety Considerations .....	18
<b>O</b>	<b>OPERATION .....</b>	<b>23</b>
	Menu Tree Additions .....	24
	Test Lead Connection .....	25
	Start Up Procedure .....	35
	Creating a Test Setup .....	37
	Automatic Tests .....	51
	Common Utility Settings .....	63
<b>R</b>	<b>REMOTE CONTROL .....</b>	<b>65</b>
<b>F</b>	<b>FAQ .....</b>	<b>71</b>
<b>A</b>	<b>APPENDIX .....</b>	<b>73</b>
	Fuse Replacement .....	73
	Error Messages .....	74
	Specifications .....	75
	Dimensions .....	76
	Declaration of Conformity .....	78
<b>I</b>	<b>INDEX .....</b>	<b>79</b>

# S SAFETY INSTRUCTIONS

This chapter contains important safety instructions that you must follow during operation and storage. Read the following before any operation to ensure your safety and to keep the instrument in the best possible condition.

## Safety Symbols

These safety symbols may appear in this manual or on the instrument.

---

 **WARNING** Warning: Identifies conditions or practices that could result in injury or loss of life.

 **CAUTION** Caution: Identifies conditions or practices that could result in damage to the instrument or to other properties.

 **DANGER High Voltage**

 **Attention Refer to the Manual**

 **Protective Conductor Terminal**

 **Frame or Chassis Terminal**

 **Earth (ground) Terminal**



Do not dispose electronic equipment as unsorted municipal waste. Please use a separate collection facility or contact the supplier from which this instrument was purchased.

## Safety Guidelines

---

### General Guideline



#### CAUTION

- Do not place any heavy object on the instrument.
- Avoid severe impact or rough handling that leads to damaging the instrument.
- Do not discharge static electricity to the instrument.
- Use only mating connectors, not bare wires, for the terminals.
- Do not block the cooling fan opening.
- Do not disassemble the GSB-01/GSB-02 unless you are qualified.

(Measurement categories) EN 61010-1:2010 specifies the measurement categories and their requirements as follows. The GSB-01/GSB-02 falls under category II.

- Measurement category IV is for measurement performed at the source of low-voltage installation.
- Measurement category III is for measurement performed in the building installation.
- Measurement category II is for measurement performed on the circuits directly connected to the low voltage installation.

---

### Power Supply



#### WARNING

- AC Input voltage range: 100 - 240VAC  $\pm 10\%$
  - Frequency: 50Hz/60Hz
  - To avoid electrical shock connect the protective grounding conductor of the AC power cord to an earth ground.
-

<p>Fuse</p>  <p>WARNING</p>	<ul style="list-style-type: none"> <li>• Fuse Type: T 2A/250V</li> <li>• To ensure fire protection, replace the fuse only with them specified type and rating.</li> <li>• Disconnect the power cord before replacing the fuse.</li> <li>• Make sure the cause of the fuse blowout is fixed before replacing the fuse.</li> </ul>
<p>Cleaning the GSB-01/GSB-02</p>	<ul style="list-style-type: none"> <li>• Disconnect the power cord before cleaning.</li> <li>• Use a soft cloth dampened in a solution of mild detergent and water. Do not spray any liquid.</li> <li>• Do not use chemicals containing harsh material such as benzene, toluene, xylene, and acetone.</li> </ul>
<p>Operation Environment</p>	<ul style="list-style-type: none"> <li>• Location: Indoor, no direct sunlight, dust free, almost non-conductive pollution (Note below)</li> <li>• Relative Humidity: <math>\leq 70\%</math> (no condensation)</li> <li>• Altitude: <math>&lt; 2000\text{m}</math></li> <li>• Temperature: <math>0^{\circ}\text{C}\sim 40^{\circ}\text{C}</math></li> </ul> <p>(Pollution Degree) EN 61010-1:2010 specifies the pollution degrees and their requirements as follows. The GSB-01/GSB-02 falls under degree 2.</p> <p>Pollution refers to “addition of foreign matter, solid, liquid, or gaseous (ionized gases), that may produce a reduction of dielectric strength or surface resistivity”.</p> <ul style="list-style-type: none"> <li>• Pollution degree 1: No pollution or only dry, non-conductive pollution occurs. The pollution has no influence.</li> <li>• Pollution degree 2: Normally only non-conductive pollution occurs. Occasionally, however, a temporary conductivity caused by condensation must be expected.</li> <li>• Pollution degree 3: Conductive pollution occurs, or dry, non-conductive pollution occurs which becomes conductive due to condensation which is expected. In such conditions, equipment is normally protected against exposure to direct sunlight, precipitation, and full wind pressure, but neither temperature nor humidity is controlled.</li> </ul>

**Storage environment**

- Location: Indoor
  - Temperature: -10°C to 70°C
  - Relative Humidity:  $\leq 85\%$  (no condensation)
- 

**Disposal**

Do not dispose this instrument as unsorted municipal waste. Please use a separate collection facility or contact the supplier from which this instrument was purchased. Please make sure discarded electrical waste is properly recycled to reduce environmental impact.

## Power cord for the United Kingdom

When using the scanner box in the United Kingdom, make sure the power cord meets the following safety instructions.

NOTE: This lead/appliance must only be wired by competent persons



**WARNING: THIS APPLIANCE MUST BE EARTHED**

IMPORTANT: The wires in this lead are coloured in accordance with the following code:

Green/ Yellow:	Earth
Blue:	Neutral
Brown:	Live (Phase)



As the colours of the wires in main leads may not correspond with the coloured marking identified in your plug/appliance, proceed as follows:

The wire which is coloured Green & Yellow must be connected to the Earth terminal marked with either the letter E, the earth symbol  $\oplus$  or coloured Green/Green & Yellow.

The wire which is coloured Blue must be connected to the terminal which is marked with the letter N or coloured Blue or Black.

The wire which is coloured Brown must be connected to the terminal marked with the letter L or P or coloured Brown or Red.

If in doubt, consult the instructions provided with the equipment or contact the supplier.

This cable/appliance should be protected by a suitably rated and approved HBC mains fuse: refer to the rating information on the equipment and/or user instructions for details. As a guide, a cable of 0.75mm<sup>2</sup> should be protected by a 3A or 5A fuse. Larger conductors would normally require 13A types, depending on the connection method used.

Any exposed wiring from a cable, plug or connection that is engaged in a live socket is extremely hazardous. If a cable or plug is deemed hazardous, turn off the mains power and remove the cable, any fuses and fuse assemblies. All hazardous wiring must be immediately destroyed and replaced in accordance to the above standard.



# G E T T I N G S T A R T E D

This chapter describes the scanner box in a nutshell, including its main features and front / rear panel introduction. After going through the overview, please read the safety considerations.



<b>GSB-01 and GSB-02 Overview.....</b>	<b>10</b>
Lineup.....	10
Firmware Note.....	10
Model Overview.....	10
Main Features .....	11
Accessories and Package Contents .....	11
<b>Appearance .....</b>	<b>13</b>
GSB-01 Front Panel .....	13
GSB-02 Front Panel .....	13
GSB-01 Rear Panel.....	16
GSB-02 Rear Panel.....	16
<b>Safety Considerations.....</b>	<b>18</b>
Workplace Precautions.....	18
Operating Precautions.....	20
Basic Safety Checks .....	22

## GSB-01 and GSB-02 Overview

### Lineup

The aim of these scanner boxes is to allow multiple DUTs to be tested either concurrently or in sequence using the GPT-9800, GPT-9900 or GPT-9900A safety testers. The scanner boxes are particularly well suited for multi-point safety testing as well for volume testing on factory floors.

The GSB-01 has connections for ACW, DCW and IR testing, while the GSB-02 also includes support for GB testing.

### Firmware Note

Please make sure the firmware is up to date before using the scanner boxes. Please see the user manual to check the firmware version.

GPT-9800: firmware version V3.0 or above

GPT-9900/9900A: firmware version V2.0 or above

Note: Throughout this user manual, the terms scanner box or GSB will refer to either model (GSB-01, GSB-02) unless specifically stated otherwise. GPT-9000 will refer to any of the GPT-9800, GPT-9900 or GPT-9900A safety testers, unless stated otherwise. HV and H will refer to High Voltage terminals, while LO and L will refer to the return terminal.

### Model Overview

Model name	ACW	DCW	IR	GB	Outputs
GSB-01	✓	✓	✓		8 x HV
GSB-02	✓	✓	✓	✓	6 x HV, 2 x GB

## Main Features

---

- |             |  |
|-------------|--|
| Performance | <ul style="list-style-type: none"> <li>• 8 HV outputs (6 for GSB-02)</li> <li>• 2 GB outputs (GSB-02 only)</li> <li>• ACW: 5kV AC</li> <li>• DCW: 6kV DC</li> <li>• IR: 1kV DC</li> <li>• GB: 40A (GSB-02 only)</li> </ul> |
| Features    | <ul style="list-style-type: none"> <li>• PASS/FAIL LEDs</li> <li>• HI LO LEDs</li> <li>• Up to 4 scanner boxes can be connected</li> </ul>   |
| Interface   | <ul style="list-style-type: none"> <li>• RS-232 interface.</li> </ul>  |
- 

## Accessories and Package Contents

---

Standard Accessories	Part Number	Description
	N/A	GSB-01/02 unit
	N/A	Quick start guide
	N/A	User manual CD
	Region dependent	Power cord
	GHT-108 x1	High voltage wiring leads
	GHT-109 x1	GB wiring leads (GSB-02 only)
	GHT-116R x8(GSB-01), x6(GSB-02)	HV test leads for scanner box outputs
	GHT-116B x1	Return test lead for scanner box

GTL-116R x2	GB sense/source H test lead (GSB-02 only)
GTL-116B x1	GB sense/source L test lead (GSB-02 only)
GTL-235	RS232C Cable

---

**Note**

Keep the packaging, including the box, polystyrene foam and plastic envelopes should the need arise to return the unit to GW Instek.

# Appearance

## GSB-01 Front Panel

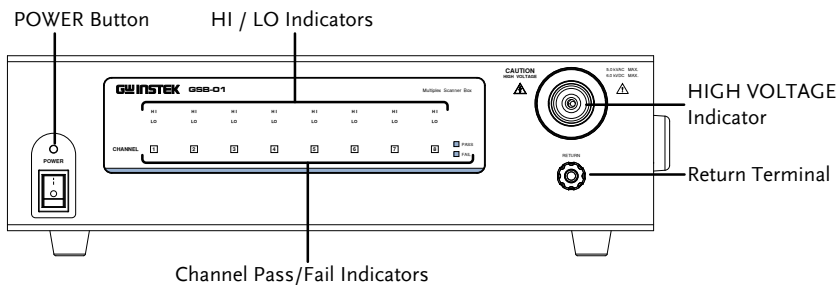

## GSB-02 Front Panel

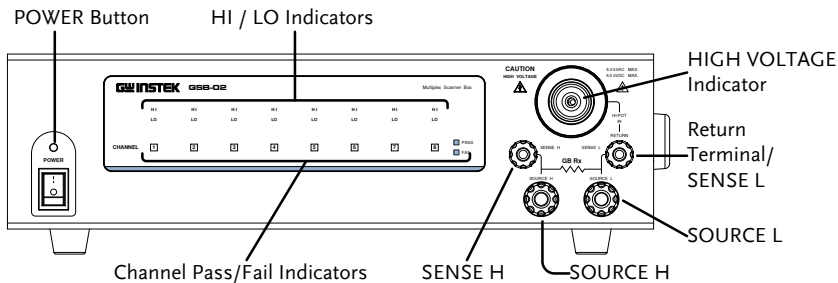

POWER switch

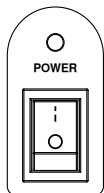

Turns the unit on or off. It is recommended that the unit is powered up before the connected safety tester is turned on.

HI LO Indicators The HI/LO Indicators indicate whether a channel is set to the HI or LO output. If neither HI nor LO is lit, it indicates that that channel is disabled.

Channel Indicators The Channel Indicators will become lit green on a pass judgment or red on a fail judgment.

HIGH VOLTAGE output terminal

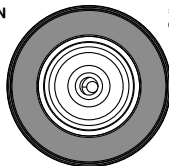

The HIGH VOLTAGE terminal output is used for outputting the testing voltage. The terminal is recessed for safety. This terminal is used in conjunction with the RETURN terminal.



**WARNING**

**USE EXTREME CAUTION.**

Do not touch the HIGH VOLTAGE terminal during testing.

RETURN terminal



The RETURN terminal is used for IR, DCW and ACW tests.

RETURN, SENSE GSB-02 Only  
and SOURCE  
terminals

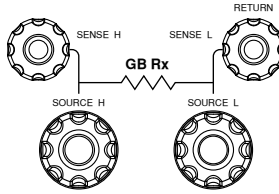

The RETURN terminal  
is used for IR, DCW  
and ACW tests.

The SOURCE H,  
SOURCE L, SENSE H  
and SENSE L terminals  
are used for GB tests.





HV1, HV2

The HV1 input terminal is used as the primary high voltage input for the scanner box. The HV2 output terminal is used to daisy chain the high voltage output to the next scanner when multiple scanner boxes are used together.

CH1 ~ CH8

These channels are connected to the DUTs that are to be tested. The output state is configured from the GPT-9000 safety tester master.

Note: For the GSB-02 CH7 and CH8 are used for ground bond testing only.

RS232/IN

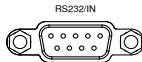

These two RS232 interfaces are the communication links between the master (safety tester) to slave (scanner box). They are also used to connect multiple scanner boxes in a daisy chain.

RS232/OUT

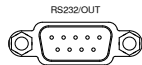

In addition the RS232/IN port is also used to perform firmware updates.

Line voltage input

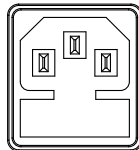

Line voltage input: 100-240VAC, 50/60Hz.

Line voltage fuse

Line voltage fuse:

T 2A/250V

GND



Connect the GND (ground) terminal to the earth ground to ensure operational safety.

# Safety Considerations

## Workplace Precautions

---

**Background**            The GPT-9000 is a high voltage instrument that outputs dangerous voltages. The following section describes precautions and procedures that must be followed to ensure a safe work environment when GSB-01/GSB-02 is connected to the GPT-9000 series safety testers.

---



### WARNING

The GPT-9000 generates voltages in excess of 5kVAC or 6kVDC. Follow all safety precautions, warnings and directions given in the following section when using the instrument with the scanner boxes.

---

1. Only technically qualified personnel should be allowed to operate the safety tester and scanner box(es).
2. The operating workplace must be fully isolated, especially when the instrument is in operation. The instruments should be clearly labeled with appropriate warning signage.
3. The operator should not wear any conductive materials, jewelry, badges, or other items, such as wrist watches.
4. The operator should wear insulation gloves for high voltage protection.
5. Ensure the earth ground of the line voltage is properly grounded.

6. Ensure any devices that are adversely affected by magnetic fields are not placed near the tester and scanner box(es).

## Operating Precautions

---

**Background**            The GPT-9000 is a high voltage instrument that outputs dangerous voltages. The following section describes precautions and procedures that must be followed to ensure that the tester along with any conned scanner boxes are operated in a safe manner.

---



The GPT-9000 generates voltages of up to 5kVAC or 6kVDC. Follow all safety precautions, warnings and directions given in the following section when using the instrument.

---

1. Never touch the safety tester, lead wires, terminals, probes, connected scanner box(es) or any other connected equipment when the tester is testing.
2. Do not turn the safety tester on and off quickly or repeatedly. When turning the power off, please allow a few moments before turning the power back on. This will allow the protection circuits to properly initialize.

Do not turn the power off when a test is running, unless in an emergency.

3. Only use those test leads supplied with the instrument. Leads with inappropriate gauges can be dangerous to both the operator and the instrument.  
For GB testing, never use the Sense leads on the SOURCE terminals.
4. Do not short the HIGH VOLTAGE terminal with ground. Doing so could charge the chassis to dangerously high voltages.

5. Ensure the earth ground of the line voltage is properly grounded.
6. Only connect the test leads to the HIGH VOLTAGE/SOURCE H/SENSE H terminals before the start of a test. Keep the test leads disconnected at all other times.
7. Always press the STOP button when pausing testing.
8. Do not leave the safety tester unattended. Always turn the power off when leaving the testing area.
9. When remotely controlling the safety tester, ensure adequate safety measures are in place to prevent:
  - Inadvertent output of the test voltage.
  - Accidental contact with the instrument during testing. Ensure that the instrument and DUT are fully isolated when the instrument is remotely controlled.
10. Ensure an adequate discharge time for the DUT.

When DCW or IR tests are performed, the DUT, test leads and probes become highly charged. The GPT-9000 has discharge circuitry to discharge the DUT after each test. The time required for a DUT to discharge depends on the DUT and test voltage.

Never disconnect the safety tester before a discharge is completed.

## Basic Safety Checks

---

Background                      The GSB-01/GSB-02 are used with high voltage devices and as such, daily safety checks should be made to ensure safe operation.

---

1. Ensure all test leads are not broken and are free from defects such as cracks or splitting.
  2. Ensure the scanner box(es) are always connected to an earth ground.
  3. Test the operation of the safety tester + scanner box(es) with a low voltage/current output:  
    Ensure the safety tester generates a FAIL judgment when the HIGH VOLTAGE and RETURN terminals are shorted (using the lowest voltage/current as the testing parameters).
- 



Do not use high voltages/currents when the HIGH VOLTAGE and RETURN terminals are shorted. It may result in damage to the instrument.

---

# OPERATION

---

<b>Menu Tree Additions .....</b>	<b>24</b>
<b>Test Lead Connection .....</b>	<b>25</b>
Connecting GSB-01 Units .....	25
Connecting GSB-02 .....	29
DUT Connection.....	32
<b>Start Up Procedure.....</b>	<b>35</b>
Startup.....	35
Connection Check .....	36
<b>Creating a Test Setup.....</b>	<b>37</b>
Scanner Box Test Creation Workflow.....	38
Select a Manual Test.....	38
Configure the Manual Test Settings .....	40
Configuring the Scanner Box Outputs .....	41
Running a Manual Test .....	44
MANU Test Results .....	48
<b>Automatic Tests .....</b>	<b>51</b>
Create an Automatic Test.....	51
Running an Automatic Test.....	54
Automatic Test Results.....	58

# Menu Tree Additions

When the scanner boxes are added to the GPT-9000 safety tester the scan utility and the scanner configuration menu become available. These additional menu functions are highlighted in the menu tree below.

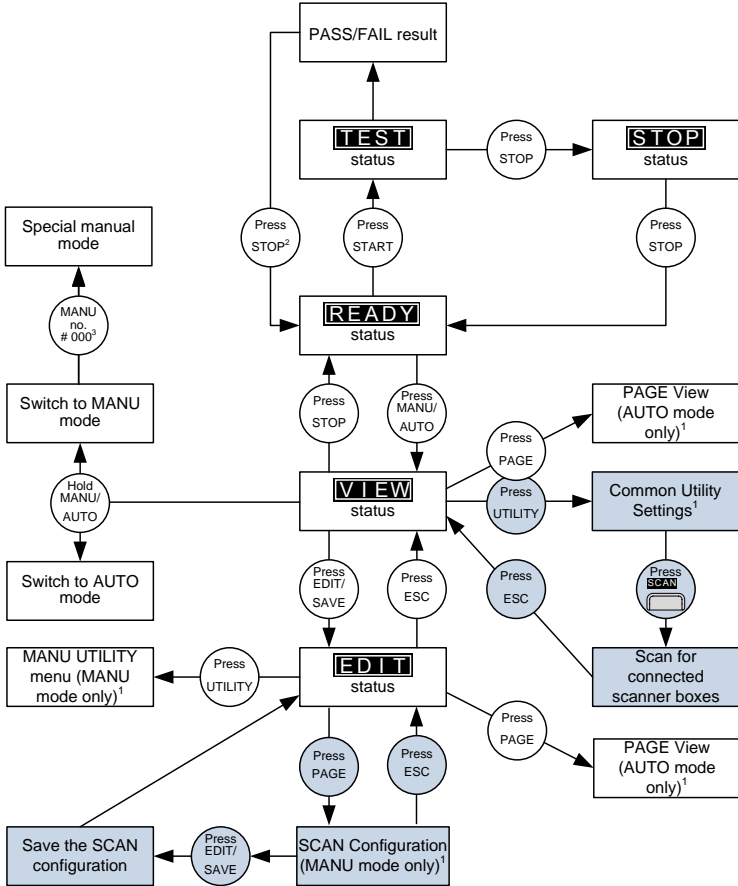

1 Press EDIT/SAVE to save settings, or ESC to cancel and return to the previous screen.  
2 Press the STOP key twice for a FAIL result.  
3 When in MANU mode, selecting MANU number 000 will enter the special manual mode.  
4 The Sweep mode function is only accessible in the special manual mode.



## Test Lead Connection

This section describes how to connect the GPT-9000 to a number of scanner boxes. It is recommended that only models of the same type are connected together.

### Connecting GSB-01 Units

---

**Background**                      The following will describe how to connect scanner boxes to a GPT-9000 safety tester. Up to 4 scanner boxes can be connected. When wiring the scanner boxes to the safety tester or to each other, only the HV wiring leads (GHT-108) should be used.

When connected, all the high voltage and all the return terminals will have been connected in a daisy chain manner.

---



#### WARNING

Ensure the safety tester is off when connecting the scanner boxes to the safety tester.

---

- Front Panel**
1. Connect the high voltage terminal on the safety tester to the high voltage terminal on the 1<sup>st</sup> scanner box, as shown below.
  2. Connect the return terminal on the safety tester to the return terminal on the 1<sup>st</sup> scanner box.
  3. Connect the return terminal on the 2<sup>nd</sup> scanner box to the return terminal on the 3<sup>rd</sup> scanner box.
-

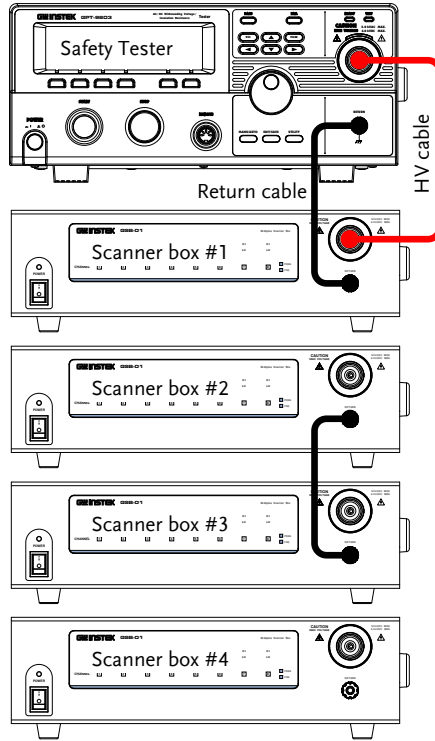

## Rear Panel

1. Connect the rear panel HV terminals together on the scanners.

HV2 (box #1) → HV1 (box #2)

HV2 (box #2) → HV1 (box #3)

HV2 (box #3) → HV1 (box #4)

2. Connect the Return terminals together on scanners\*.

Return (box #1) → Return (box #2)

Return (box #3) → Return (box #4)

\*Box #2 does not need to be connected to box #3 as it was already connected from the front panel.

3. Connect the RS232 ports from the safety tester to each scanner box in a daisy chain using the RS232C cables.

RS232 (safety tester) → RS232/IN (box #1)

RS232/OUT (box#1) → RS232/IN (box #2)

RS232/OUT (box#2) → RS232/IN (box #3)

RS232/OUT (box#3) → RS232/IN (box #4)

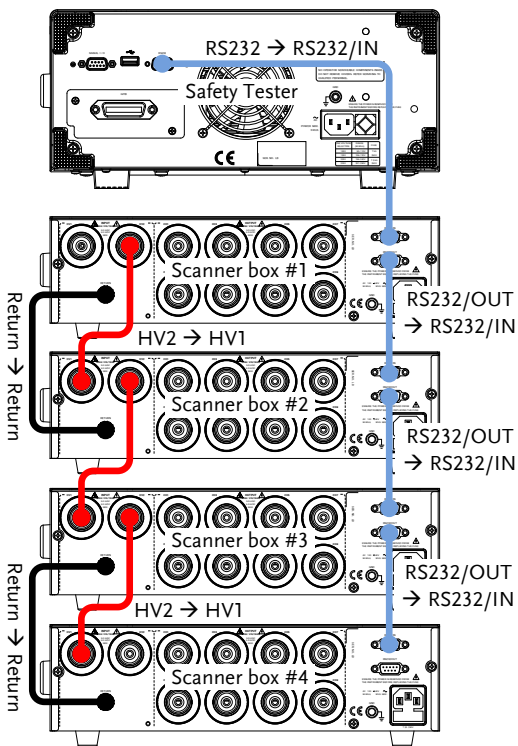

## Connecting GSB-02

---

**Background**                      The following will describe how to connect scanner boxes to a GPT-9000 series safety tester with ground bond test support. Up to 4 scanner boxes can be connected. In the examples below only 3 scanner boxes are connected.

When wiring the scanner boxes to the safety tester or to each other, only the GB wiring leads (GHT-109) should be used.

---

**Front Panel**                      1. Connect the SOURCE H and SOURCE L terminals on the safety tester to the same terminals on the 1<sup>st</sup> scanner box.

2. Connect the SENSE H and SENSE L terminals on the safety tester to the same terminals on the 1<sup>st</sup> scanner box.

---

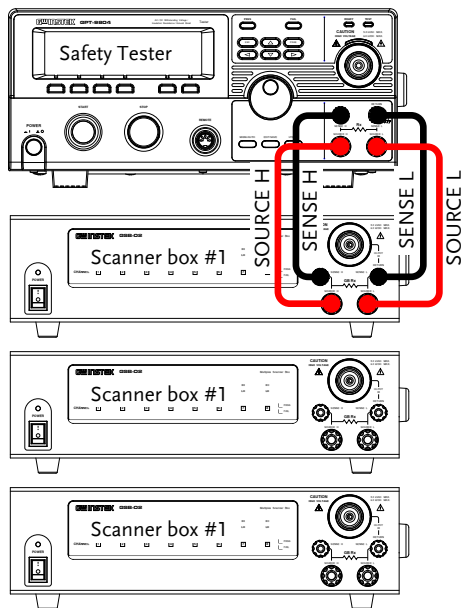

**Rear Panel**

1. Connect the SOURCE H and SOURCE L terminals on the 1<sup>st</sup> scanner box in series to the same terminals on the 2<sup>nd</sup> and 3<sup>rd</sup> scanner box.
2. Connect the SENSE H and SENSE L terminals on the 1<sup>st</sup> scanner box in series to the same terminals on the 2<sup>nd</sup> and 3<sup>rd</sup> scanner box.
3. Connect the RS232 ports from the safety tester to each scanner box in a daisy chain using the RS-232C cables.

RS232 (safety tester) → RS232/IN (box #1)  
 RS232/OUT (box#1) → RS232/IN (box #2)  
 RS232/OUT (box#2) → RS232/IN (box #3)

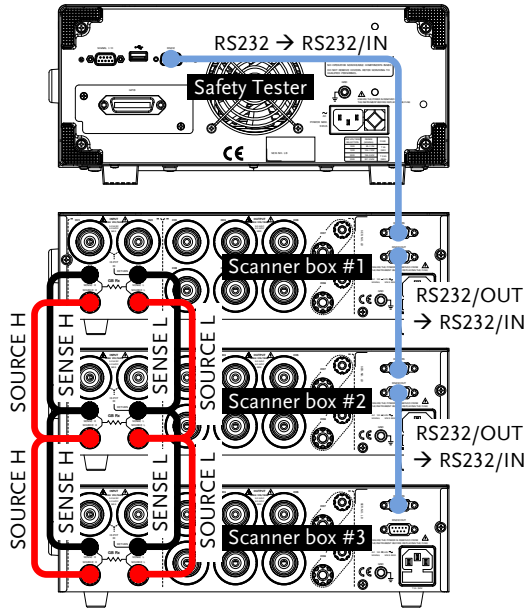

## DUT Connection

### Background

The terminals on the rear panel of the scanner boxes are divided into two sections, input and output.

The input section is used (as shown previously) to daisy chain scanner boxes together.

The output section is used to connect up to 8 DUTs. The GSB-01 is only used for DCW, ACW and IR testing. The GSB-02 (shown) replaces two high voltage terminals with a pair of SENSE H/SOURCE H terminals for GB testing.

For all 8 channels (GSB-01) or channel 1~6(GSB-02) the terminals can be assigned as either HV or LO (High voltage or return) terminals on the GPT safety tester. This allows the scanner boxes to be quite flexible to your testing needs.

### NOTE

The GB outputs (channel 7 and 8) can only be configured as HI terminals or be disabled.

### Input and Output Areas on the Rear Panel

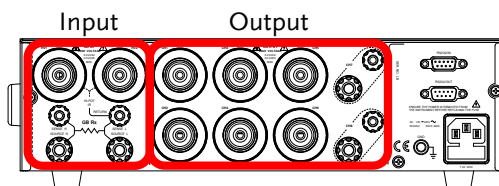

### Examples

Below are some possible DUT test setups as examples. Note that you are not limited to those shown below.



Example 1: GB connection with common LO terminals. GTL-116B and GTL-116R test leads are to be used.

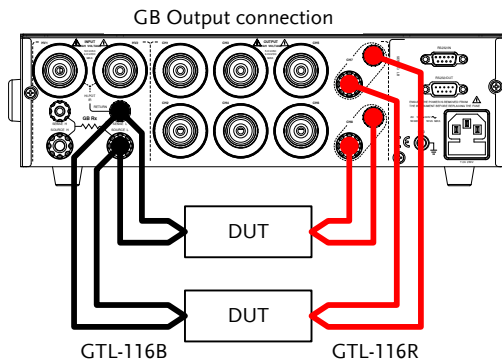

Example 2: IR, ACW, DCW connection with separately configured HI & LO terminals. GHT-116R and GHT-116B test leads are to be used.

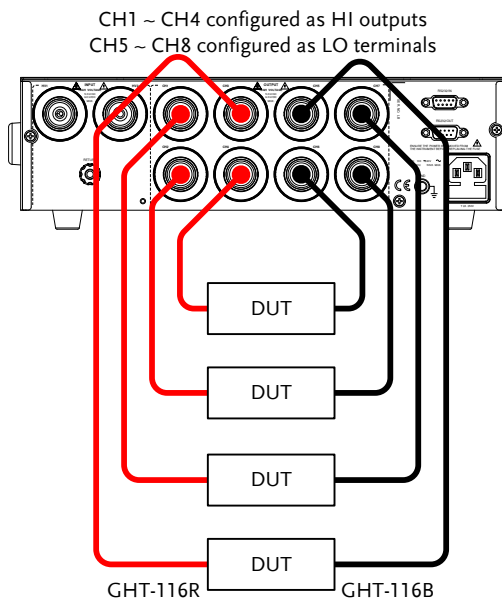

Example 3: IR, ACW, DCW connections with common return terminal. These tests are best performed sequentially. GHT-116R and GHT-116B test leads are to be used.

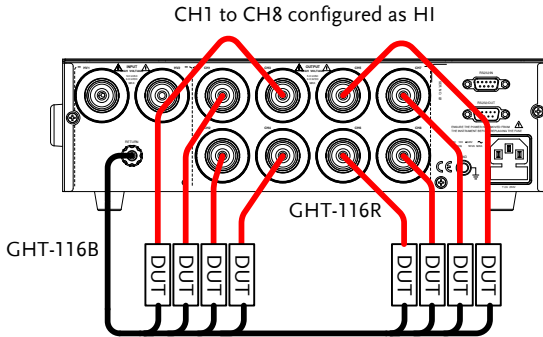

# Start Up Procedure

## Startup

---

**Background**                      The power up sequence as well as the connections between each scanner box and the safety tester are critical to operate the scanners correctly.

---

- Steps**
1. Make sure the safety tester and all scanner boxes are turned off.
  2. Connect each scanner box to a master safety tester in a daisy chain, as shown on page 25.
    - Make sure the RS232 cables are connected to the correct ports.
    - Make sure the Input and Output cables are connected properly.

3. Turn on the scanner boxes from the power switches.

Each power LED will be lit red.



4. Turn the GPT-9000 power on. It is essential that the GPT-9000 is turned on after the scanner boxers.

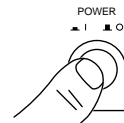

**Startup Screen**

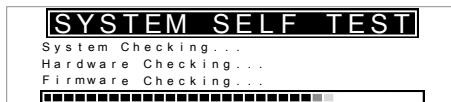

## Connection Check

**Background**                      The scanner connection can be checked in the Common Utility menu.

**Steps**                              1. Ensure the tester is in VIEW status.

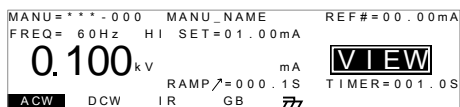

2. Press the UTILITY key.



3. Press the SCAN soft-key to view any connected scanner boxes. Any scanner boxes will be displayed in order from 1 to 4.



**Example**

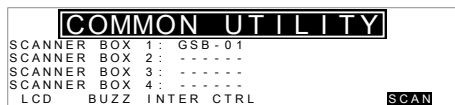

In the example above, only one scanner box (model: GSB-01) is connected.

 **Note**

If the any connected scanners are not properly connected they will not appear in the Scan Utility.

## Creating a Test Setup

This section describes how to create, edit and run tests using the scanner box interfaces. In principal we will be showing you how to configure the output terminals on the scanner box rear panel. For the GSB-01, each terminal can be configured as either an HV output (hereafter referred to as HI) or as a return terminal (hereafter referred to as LO). For the GSB-02, channels 1 to 6 can be configured to HI or LO terminals as well. However for channels 7 and 8, the GSB-02 can also configure these channels into pairs of Source/Sense HI.

Thus each terminal on the scanner boxes must be configured based on the desired test setup, as referred to in the previous chapter on page 25.



Note

Setting the test settings, test mode and general operation will not be discussed in this manual. Please see the GPT-9000 User Manual for more operation details.

---

Before operating the safety tester please read the safety precautions as outlined in the Safety Considerations chapter on page 18.

## Scanner Box Test Creation Workflow

**Background**                      The flowchart below shows the basic workflow for creating tests for the scanner boxes.

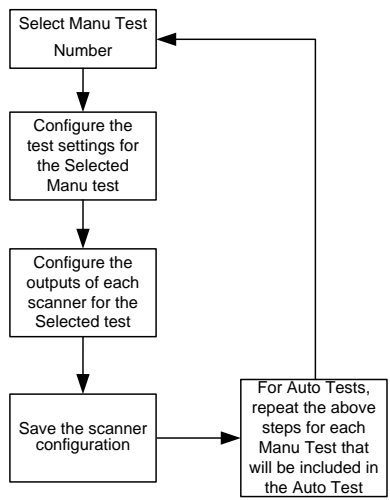

## Select a Manual Test

**Background**                      To edit any of the manual test settings, the tester must be in EDIT status.

Any settings or parameters that are edited only apply to the currently selected MANU number.

Steps

1. If the tester is in AUTO mode, press and hold the MANU/AUTO key for three seconds to switch to MANU mode.



The tester can only switch between AUTO and MANU mode when in the VIEW status.

2. Use the scroll wheel to set the MANU number.

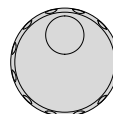

MANU number

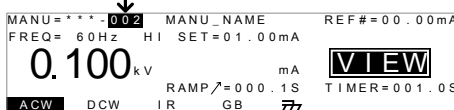

3. Press the EDIT/SAVE key when in VIEW status to enter the EDIT status. This will enter the EDIT status for the chosen test number only.

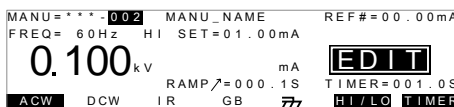

4. The Status changes from VIEW to EDIT.



Pressing the EDIT/SAVE key again will save the settings for the current test and return back to VIEW status.

## Configure the Manual Test Settings

**Background** After a MANU number has been chosen and the tester is in EDIT status, the settings for the current manual test can be configured.

**Steps** 1. To choose the test function, press the ACW, DCW, IR or GB soft-keys.



2. The test function soft-key is highlighted.

3. Press the UP / DOWN arrow keys to bring the cursor to a function setting.

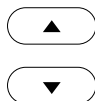

4. Use the scroll wheel to set the value of the function setting.

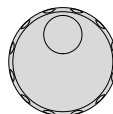

**Example**

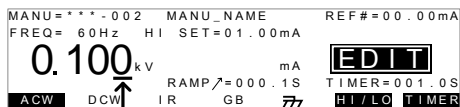

cursor

5. Repeat steps 3 and 4 for the remaining settings.

6. Press the EDIT/SAVE key to save and save the manual test and go back to VIEW status.



**Note**

For detailed instructions on how to set the various function settings, please see the user manual.





## Configuring the Scanner Box Outputs

**Background** The scanner box output is configured separately for each manual test. This allows you to have one manual test to test multiple DUTs at the same time from a number of scanner boxes.

For automatic tests, each manual test can be seen as configuring the output of one step of the automatic test.

This section will assume that you are only configuring a single manual test. For automatic tests, repeat the instructions below for each manual test that is added to the automatic test.

 **Note** For the GSB-02, the GB outputs can only be set to HI or disabled.

 **Note** The following settings will only apply to the current manual test.

### Overview

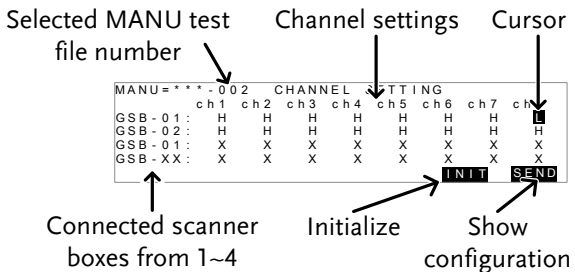

### Steps

1. Press the EDIT/SAVE key when in VIEW status to enter the EDIT status. This will enter the EDIT status for the currently selected manual test.

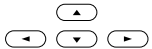

2. Press the PAGE key to bring up the Scanner Configuration Page view for the currently selected manual test. 

3. Press the UP/DOWN and LEFT/RIGHT arrows keys to move the cursor to the desired channel and scanner box. 

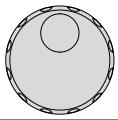
4. Use the scroll wheel to set the selected channel on the selected scanner box as H or L or X. 

- H Sets the channel as a HV terminal (or Source H/Sense H terminals for GSB-02)

---

- L Sets the channel as a return terminal (For the GSB-02, the GB terminals can only be configured to H or X(disabled))

---

- X Disables the channel

**Example**

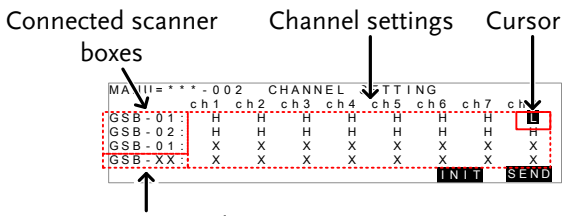

Not connected

In the example above scanner box#1 has ch1~7 configured as H and ch8 configured as L. Scanner box#2 has ch1~8 configured as H.

5. Press the EDIT/SAVE key to save the scanner output settings for the current manual test. 

- 
6. A test can now be started, see page on 44 to get started.
- 

Initialize

7. Pressing the INIT key will initialize all the channels to "X", disabling all the channels.



Send

8. Pressing SEND will output the channel settings onto the connected scanner boxes.



Note

If a number of terminals are turned on at the same time, then the voltage/current that is set on the safety tester must be divided by the number of channels that are turned on for the test. For example, if channels 1 to 3 are turned on for an ACW test, then the test current must be divided by 3 to determine the result from each channel (assuming identical DUTs).

---

## Running a Manual Test

**Background**                      A test can be run when the tester is in READY status.



The tester cannot start to run a test under the following conditions:

- A protection setting has been tripped; when a protection setting has been tripped the corresponding error message is displayed on the screen.
- The INTERLOCK function is ON and the Interlock key is not inserted in the signal I/O port.
- The STOP signal has been received remotely.

If Double Action is ON, ensure the START button is pressed immediately after the STOP button (<0.5s).



When a test is running the voltage output cannot be changed, unless the test is under the special manual mode.

**Steps**                              1. Ensure a MANU test is selected and the tester is in VIEW status.

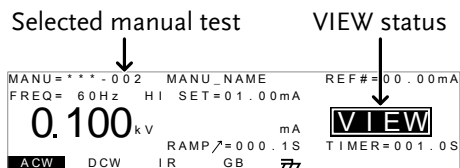

2. Press the STOP button to put the tester into the READY status.

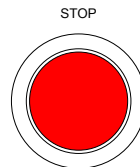

READY status

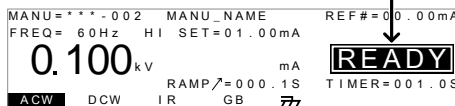

3. The READY indicator will be lit blue when in the READY status.



4. Press the START button when the tester is in the READY status. The manual test starts automatically and the tester goes into the TEST status.

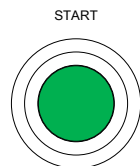

5. The TEST indicator will be lit orange when in the TEST status.



TEST status

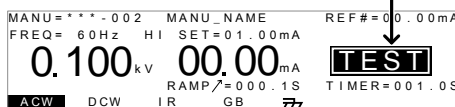

- The HI or LO indicators of the channels that are turned on for the manual test will be shown on the respective scanner boxes.

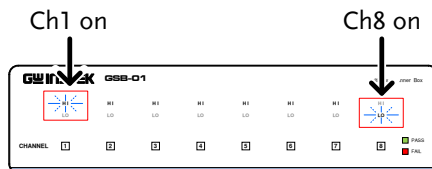

- The test will start by showing the remaining ramp up time, followed by the remaining test time. The test will continue until the test is finished or the test is stopped.

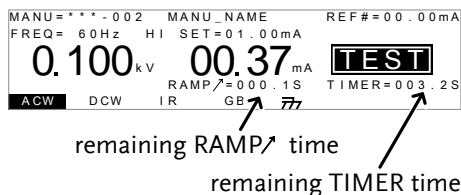

**Stop the Test**

- To stop the test at any time when it is running, press the STOP button. The test will stop immediately. When the STOP button is pressed, a judgment is not made on the test.

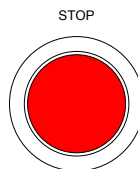

All panel keys except the STOP button are locked when the tester is in STOP status.

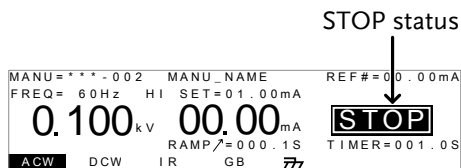

9. To put the tester back into READY status, press the STOP button again.

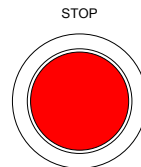

Exit TEST Status

To exit testing, press the MANU/AUTO key when the tester is in the READY status. The tester will revert to the VIEW status for the current test.



```

MANU=***-002  MANU_NAME  REF#=00.00mA
FREQ= 60Hz  HI SET=01.00mA
0.100 kV  mA  VIEW
RAMP=000.1S  TIMER=001.0S
ACW  DCW  IR  GB  77
  
```



Note

Do not touch any terminals, test leads or any other connections when the test is on.

## MANU Test Results

---

### Background

If the test is allowed to run to completion (the test is not stopped or a protection setting is not tripped) then the tester will judge the test(s) as either PASS or FAIL.

The pass/fail result of the test(s) is shown on the safety tester display and the scanner box(s).

Please note that when multiple DUTs are tested simultaneously and a fail result is produced, it indicates that at least one DUT failed the test. It doesn't indicate which of the DUTs passed or failed. Each DUT would have to be tested separately to determine that.

---



### Note

The test will be judged PASS when:

- The HI SET and LO SET limits have not been tripped during the test time.

The test will be judged FAIL when:

- Either the HI SET or LO SET limit has been tripped during the test time.
- A protection setting has been tripped during the test time.

Test may not finish if the scanner boxes are not properly connected.

---



PASS Judgment

1. When the test is judged as PASS, PASS will be displayed, the buzzer will sound, the PASS indicator will be lit green and the channel indicator will be lit green.

PASS



Safety tester example



Scanner display example

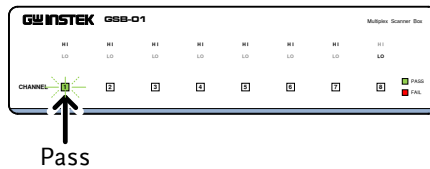

2. The PASS judgment will be held on both the safety tester and scanner displays until the STOP or START button is pressed.

Pressing the STOP button will return the tester to the READY status.

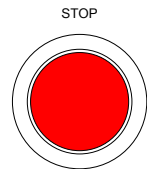

Pressing the START button will restart the test.

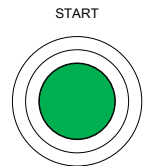

 Note

The buzzer will only sound if the Pass Sound is set to ON.

The START button is disabled when the buzzer is beeping.

FAIL Judgment

- When the test is judged as FAIL, FAIL will be displayed on the safety tester, the FAIL indicator will be lit red, the channel indicator on the scanner will be lit red and the buzzer will sound.



As soon as a test is judged FAIL, power is cut from the terminals.

Safety tester example

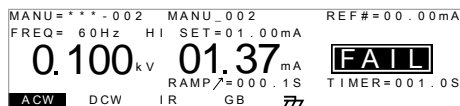

Scanner display example

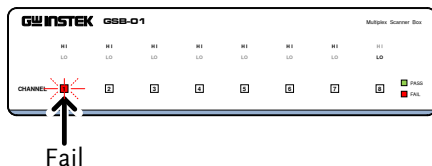

- The FAIL judgment will be held on the safety tester display and the scanner(s) until the STOP button is pressed. Pressing the STOP button twice will return the tester to the READY status.

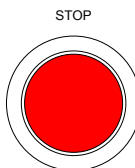

- The READY indicator will be lit blue in the READY status.



READY status

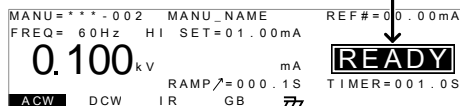

Note

The buzzer will only sound if Fail Sound is set to ON.

## Automatic Tests

This section describes how to create and run automatic tests for the GSB-01/GSB-02 scanner boxes.

An automatic test comprises of up to 16 MANU tests that are run sequentially. In order to run an automatic test using the GSB-01/GSB-02 scanner boxes, the *scanner outputs for each manual test must first be configured*, and then each manual test in the automatic test can be stepped through. In other words, the channel outputs are directed by the manual tests that comprise the automatic test.

It is assumed that you have read and understood how to create an automatic test on the GPT-9000 safety tester. If you are not sure how to create and run an automatic test on the safety tester, please see the GPT-9000 user manual.

Before operating the GPT-9000 please read the safety precautions as outlined in the Set Up chapter on page 18.

### Create an Automatic Test

---

Background	It is assumed that you already know how to create an automatic test. This section will only give the essential instructions for creating an automatic test. For more comprehensive details, please see the GTP-9000 user manual.
------------	--

---

- |       |  |
|-------|--|
| Steps | <ol style="list-style-type: none"> <li>1. If the tester is in MANU mode, press and hold the MANU/AUTO key for three seconds. This will put the tester into Auto mode.</li> </ol> |
|-------|--|



The tester can only switch between AUTO and MANU mode when in the VIEW status.

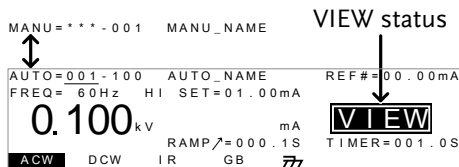

2. Use the scroll wheel to choose the AUTO number.

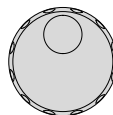

AUTO # 001~100

AUTO number

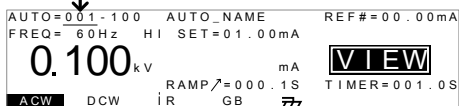

3. Press the EDIT/SAVE key when in VIEW status to enter the EDIT status. This will enter the EDIT status for the chosen AUTO number.

EDIT/SAVE

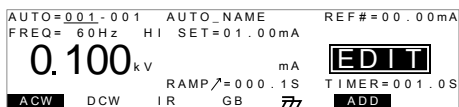

4. Press the DOWN arrow keys to bring the cursor to the MANU number, if it is not already.



cursor MANU number

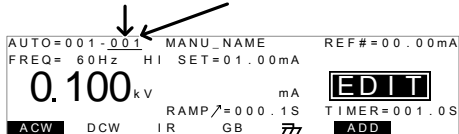

- Use the scroll wheel to choose a MANU number to add to the automatic test.

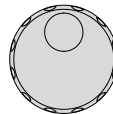

MANU number 001~100

- Press the ADD soft-key to add the selected manual test to the automatic test as another step.



- Repeat steps 5 and 6 for any other tests that you wish to add to the automatic test.
- A maximum of 16 steps can be added. FULL will be displayed when 16 steps are added.



Note

The test order can be edited in the Page View menu after the AUTO test is saved. See the user manual for details.

- When in EDIT status, press the EDIT/SAVE key to save the automatic test. After the test is saved the tester will revert back to VIEW status.

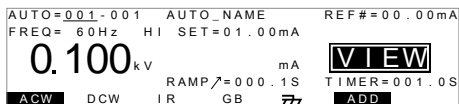

Note

Pressing the EDIT/SAVE key again will return the tester back to EDIT status for the selected AUTO test.

## Running an Automatic Test

**Background**                      Running an automatic test with the GSB-01/02 scanner boxes is the same as running an automatic test without them.



**Note**

The tester cannot start to run an AUTO test under the following conditions:

- Any protection modes have been tripped.
- The INTERLOCK function is ON and the Interlock key is not inserted in the signal I/O port.
- The STOP signal has been received remotely.

If Double Action is ON, ensure the START button is pressed immediately after the STOP button (<0.5s).



**Warning**

Do not touch any terminals, test leads or the DUT when a test is running.

### Steps

1. Ensure the tester is in VIEW status.

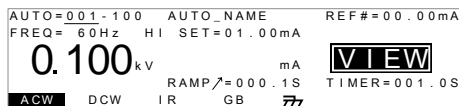

2. Press the STOP button to put the tester into the READY status.

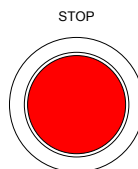

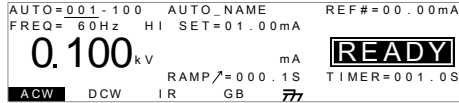

- 3. The READY indicator will be lit blue when in the READY status.



- 4. Press the START button when the tester is in the READY status. The AUTO test starts automatically and the display changes to TEST status.

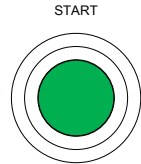

- 5. The TEST indicator will be lit orange when in the TEST status.



- 6. The HI or LO indicators of the channels that are turned on for the current step of the test will be shown on the respective scanner boxes.

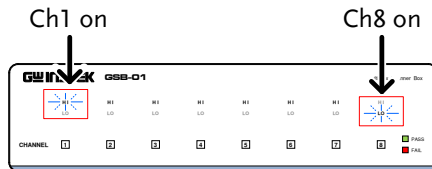

- 7. Each test will start by showing the remaining ramp up time, followed by the remaining test time. Each manual test of the automatic test will be tested in sequence until the last test has finished or the test is stopped.

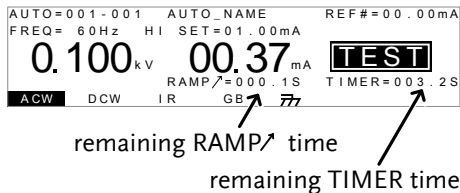

- PASS/FAIL HOLD 1. If Pass Hold is set to ON or Fail Mode is set to HOLD for a manual test, then the tester will “hold” the testing after a Pass/Fail result for that particular test.



2. The PASS or FAIL indicator will also be lit on the safety tester and the corresponding channel indicator will be lit red or green on the scanner box(es). The buzzer will NOT sound.

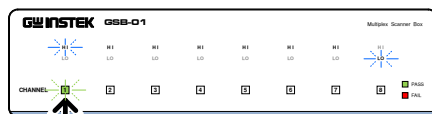

Channel indicator

3. To continue to the next test after HOLD is displayed on-screen, press the START button.

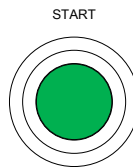



- To stop the test when HOLD is displayed on-screen, press the STOP button.

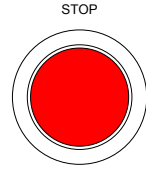

Note

When in HOLD status, only the START and STOP buttons can be pressed, all other keys are disabled.

### Stop a Running Test

- To stop the AUTO test at any time when it is running, press the STOP button. The AUTO test will stop immediately. When the STOP button is pressed, a judgment is not made on the current test and any remaining tests are aborted.

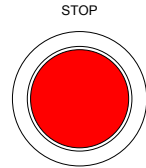

All panel keys except the STOP and START buttons are locked when the tester has been stopped. All the results up until when the AUTO test was stopped are shown on-screen.

```
AUTO=001-***  AUTO_NAME
#01: FAIL  #02: PASS  #03: STOP  #04: ----
#05: ----  #06: ----  #07: ----  #08: ----
#09:      #10:      #11:      #12:
#13:      #14:      #15:      #16:
```

Example of an automatic test that has been stopped. Dashes (-) indicate aborted test steps.

- To put the tester back into READY status, press the STOP button again.

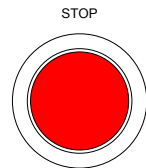

**Exit Testing**

To exit testing, press the **MANU/AUTO** key when the tester is in the **READY** status. The tester will revert to the **VIEW** status for the current automatic test.

MANU/AUTO

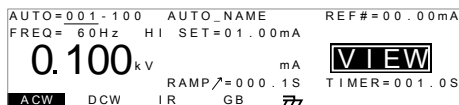

**Automatic Test Results**

**Background**

If all the test steps are allowed to run to completion (the **AUTO** test is not stopped or a protection setting is not tripped) then the tester will judge each step as either **PASS** or **FAIL**. This is shown as a table after the automatic test has finished running. If the test has been stopped, then any remaining tests will not be run and thus the **AUTO** test will not finish running.

**Overview**

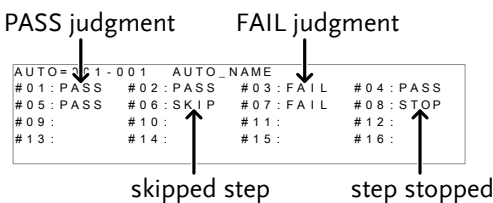

**Note**

The **PASS/FAIL** judgment for an automatic test as a whole depends on the results of all the steps (manual tests) that compose the automatic test:

- Each step must be passed for a **PASS** judgment

(excluding skipped tests).

- A FAIL result for a single step will result in FAIL for the whole automatic test.
- A STOP. No step can be stopped for a PASS/FAIL judgment to be made. In other words, if a test is stopped, it is judged as neither PASS nor FAIL.
- No step can contain an ERROR or ILOCK message.

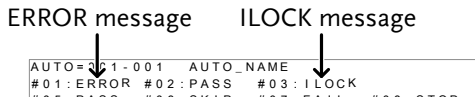

**ERROR:** Indicates that V, I or R is not correct. This usually occurs if the testing leads are not properly connected.

**ILOCK:** Indicates that the interlock key is disconnected (if configured to be used).

**PASS Judgment**

When all the tests have been judged as PASS, the PASS indicator will be lit green, each channel used in the test will be lit green and the buzzer will sound.

PASS

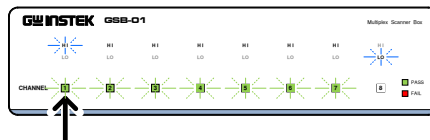

Green channel indicators, indicating a pass

**Example**

```

AUTO=001-***  AUTO_NAME
# 01 : PASS  # 02 : PASS  # 03 : PASS  # 04 : PASS
# 05 : PASS  # 06 : PASS  # 07 : PASS  # 08 : PASS
# 09 :      # 10 :      # 11 :      # 12 :
# 13 :      # 14 :      # 15 :      # 16 :
  
```



Note

The Pass Sound setting must to set to ON for the buzzer to sound.

**FAIL Judgment**

When any of the tests have been judged as FAIL, the FAIL indicator will be lit red, the channel indicator for the failed channel(s) will be lit red and the buzzer will sound.



Red channel indicators, indicating a fail

```

AUTO=001 - * * *   AUTO_NAME
# 01 : FAIL   # 02 : PASS   # 03 : FAIL   # 04 : PASS
# 05 : PASS   # 06 : PASS   # 07 : PASS   # 08 : PASS
# 09 :        # 10 :        # 11 :        # 12 :
# 13 :        # 14 :        # 15 :        # 16 :
    
```



Note

The Fail Sound setting must to set to ON for the buzzer to sound.

View Results

1. When the PASS or FAIL overview table is shown on the screen, turn the scroll wheel right to scroll through each test step.

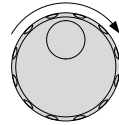

step number                      MANU number for current step

STEP: 02-003	MANU_NAME	REF#=00.00mA
FREQ= 60Hz	HI SET=01.00mA	
<b>0.100</b> kV	<b>00.37</b> mA	<b>PASS</b>
ACW	DCW	IR
	RAMP/=000.0S	GB
		77
		TIMER=003.2S

PASS/FAIL result

2. Turn the scroll wheel left to return back to the overview table.

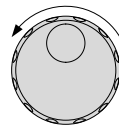

Return to Ready Status

1. The PASS/FAIL results will be held on the screen until the STOP button is pressed.
2. To put the tester back into READY status, press the STOP button (twice for a fail result).

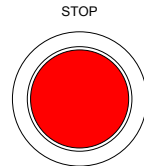

3. The READY indicator will be lit blue in the READY status.



READY status

AUTO=001-100	AUTO_NAME	REF#=00.00mA
FREQ= 60Hz	HI SET=01.00mA	
<b>0.100</b> kV		<b>READY</b>
ACW	DCW	IR
	RAMP/=000.1S	GB
		77
		TIMER=001.0S

Exit Testing

To exit testing, press the  
MANU/AUTO key when the  
tester is in the READY status. The  
tester will revert to the VIEW  
status.

MANU/AUTO

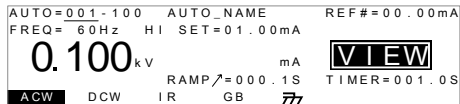

## Common Utility Settings

The Common Utility settings are system-wide settings that apply to both MANU tests and AUTO tests. The scanner boxes introduce one new interface setting.

### Scanner Box Interface Settings

---

**Description** The interface settings choose the remote interface configuration. USB, RS232 and GPIB (optional) can be selected. With the scanner box(es) installed, remote control is only possible via USB. The RS-232 interfaces are used to link the scanner boxes to the safety tester.

---

- Steps**
1. Ensure the tester is in VIEW status. Save the current test if necessary.

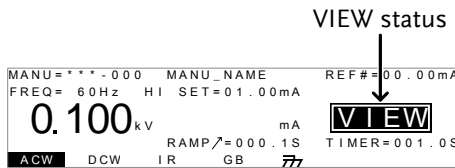

2. Press the UTILITY key.



3. Press the INTER soft-key to bring up the Interface Common Utility menu.



4. Use the scroll wheel to select SCANNER BOX.

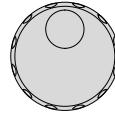

5. Press EDIT/SAVE to save the settings and exit to VIEW status.



Note

The baud rate setting is fixed to 115200 baud.

---



Note

When Interface is set to SCANNER, the remote interface is automatically set to USB.

---



Note

The ESC key can be pressed at any time to cancel and exit back to VIEW status.

---



# REMOTE CONTROL

## Scanner Commands

---

GSB:CLR .....	65
GSB:SCAN.....	65
GSB<X>:CHANnel.....	66
GSB:MEASure.....	67
GSB<X>:HI.....	68
GSB<X>:LOW .....	69

### GSB:CLR



---

Description	Clear the configuration and results from the scanner box.
-------------	---

---



Note

Only applicable in the VIEW or READY status.

Syntax	GSB:CLR
--------	---------

---

### GSB:SCAN

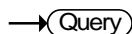

---

Description	Scans for any connected scanner boxes and returns the model type and order.
-------------	---

---



Note

Only applicable in the VIEW or READY status.

Query Syntax	GSB:SCAN?
--------------	-----------

---

Return parameter	<string>	Returns: The connection status and order of each scanner in the following format: <1st>,<2nd>,<3rd>,<4th> Where 01=GSB-01, 02=GSB-02, XX=not connected.
------------------	----------	--

Query Example    GSB:SCAN?  
 >01,02,XX,XX  
 Number #1 scanner box =GSB-01,#2=GSB-02, #3=not connected,#4= not connected.

**GSB<X>:CHANnel**

→ Query

Description	Queries setting state of each scanner box for a specified MANU number.
-------------	--

 **Note**                      Only applicable in the VIEW or READY status.

Query Syntax            GSB<X>:CHANnel?

Parameter                <X>                      1 ~ 100 (MANU number)

Return parameter	<string>	Returns the status of each scanner box in a table as follows:  <pre> 12345678&lt;cr&gt;&lt;lf&gt; GSB-01:HXXHXXXX&lt;cr&gt;&lt;lf&gt; GSB-02:XLXXXLXX&lt;cr&gt;&lt;lf&gt; GSB-XX:XXXHXXXX&lt;cr&gt;&lt;lf&gt; GSB-XX:XXXHXXXX&lt;cr&gt;&lt;lf&gt; </pre> Where the first line is the channel index and lines 2~5 are connection settings for the scanner boxes in order from 1 <sup>st</sup> to 4 <sup>th</sup> . H=Set to H/HV terminal. L=Set to Return terminal. X=Off
------------------	----------	--

Query Example    GSB1:CHAN?

```
>          12345678<cr><lf>
>GSB-01:HXXXXXXX<cr><lf>
>GSB-02:XLXXXLXX<cr><lf>
>GSB-XX:XXXXXXX<cr><lf>
>GSB-XX:XXXXXXX<cr><lf>
```

Indicates that for MANU 001, channel 1 and 4 are set to H for the GSB-01 and that channel 2 and 6 are set to L for the GSB-02.

**GSB:MEASure**



Description       Returns the test results for the scanner boxes after the test has completed.



Only applicable in the VIEW or READY status.

Pass/Fail results will be held until the “GSB:CLR” command is used or the results will be overwritten each time a new test is performed.

Query Syntax       GSB:MEASure?

Return parameter <string>       Returns the test pass/fail results in a table as follows:

```
          12345678<cr><lf>
GSB-01:PXXPXXXX<cr><lf>
GSB-02:XFXXXFX<cr><lf>
GSB-XX:XXXXXXXX<cr><lf>
GSB-XX:XXXXXXXX<cr><lf>
```

Where the first line is the channel index and lines 2~5 are the test result for the scanner boxes in order from 1<sup>st</sup> to 4<sup>th</sup>.

P=Pass  
F=Fail  
X=Test off



Example2      GSB1: HI SFF000000  
 Sets Channel 1~8 of scanner 1 to HI. All other channels are off. (FF00000 Hex = 11111111000000000000000000000000 binary)



Note

Only applicable in the VIEW or READY status.  
 If a channel is set to binary 0, it can still be set to LOW using the GSB<X>:LOW command.

**GSB<X>:LOW**

Set →

→ Query

Description      Sets or queries the LOW (return) settings for each scanner box for a selected MANU test number.

Syntax      GSB<X>:LOW <string>

Query Syntax      GSB<X>:LOW?

Parameter	<X>	1~100 (MANU number)
Parameter/Return parameter	<string>	8 character Hex code of a binary number (16 digits), prepended with "S". LOW = binary 1, other = binary 0. First 2 Hex/8 binary digits = 1 <sup>st</sup> scanner box, second 2 Hex/8 binary digits = 2 <sup>nd</sup> scanner box, third 2 Hex/8 binary digits = 3 <sup>rd</sup> scanner box, 4 <sup>th</sup> 2 Hex/8 binary digits = 4 <sup>th</sup> scanner box.

String format:

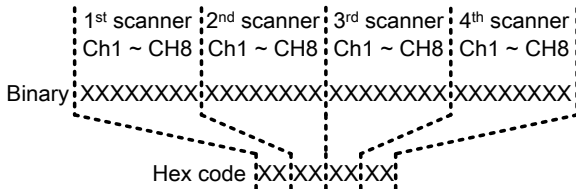

Example1      GSB1: LOW S80000000  
 Sets Channel 1 of scanner 1 to LOW. All other channels are not set. (8000000 Hex = 10000000000000000000000000000000 binary)

Example2

GSB1: LOW SFF000000

Sets Channel 1~8 of scanner 1 to LOW. All other channels are not set. (FF00000 Hex = 11111111000000000000000000000000 binary)

---



Note

Only applicable in the VIEW or READY status.

If a channel is set to binary 0, it can still be set to HI using the GSB<X>:HI command.

# F AQ

---

- I get a scanner error when I run a test.
- The tester will stop testing midway through an automatic test.
- When I press the START button the tester will not start testing?

I get a scanner error when I run a test.

---

A scanner error indicates that the HV and return terminals haven't been properly connected between the safety tester and the scanner(s).

The tester will stop testing midway through an automatic test.

---

You may have PASS HOLD turned on or FAIL MODE set to HOLD. Press the Start button to continue to the next test. See the user manual for setting details.

When I press the START button the tester will not start testing?

---

The tester must first be in the READY status before a test can be started. Ensure the tester displays READY before pressing the START button.

If "Double Action" is enabled, the START button must be pressed 0.5 seconds after the STOP button is pressed, otherwise the tester will not start testing.

If “Interlock” is enabled, the interlock key must be inserted into the signal I/O port on the rear before a test can be started.

Lastly, ensure that the Start Ctrl setting is correctly configured in the Common Utility menu. For example, to enable the START button to start a test, ensure that the Start Ctrl setting is set to FRONT PANEL.

For more information, contact your local dealer or GWInstek at [www.gwinstek.com](http://www.gwinstek.com) / [marketing@goodwill.com.tw](mailto:marketing@goodwill.com.tw).



# APPENDIX

## Fuse Replacement

---

Steps

1. Turn the instrument off.

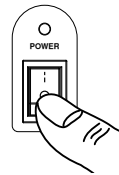

2. Take off the power cord and remove the fuse socket using a minus driver.

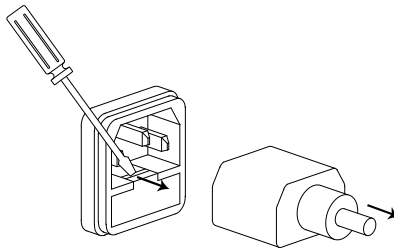

Replace the fuse in the fuse holder.

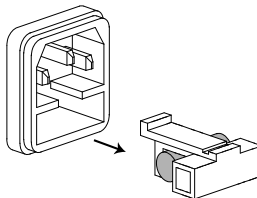

---

Rating

100V~240V

T2A 250V

---

## Error Messages

### Test Errors

---

The following error messages or messages may appear on the GPT screen when configuring or running tests.

Error Messages	Description
SCANNER ERR	Indicates that there is a problem with the scanner connection.

---

## Specifications

The specifications apply when the GSB-01/02 is powered on for at least 30 minutes at 15°C~35°C.

### Specifications

---

#### Scanner

Model	GSB-01	GSB-02
High Voltage Rating	5kV AC/6kV DC	5kV AC/6kV DC
High Current Rating		40A AC
Number of HV channels	8	6
Number of GB channels	None	2
System Interface	RS-232	RS-232
Power Source	AC 100-240V ±10%, 50/60Hz	

#### Other

Operation Environment	Indoor use, altitude up to 2000m Ambient temperature 0°C to 40°C Relative humidity 70% Installation category II Pollution degree 2
Storage Temperature & Humidity	-10°C to 70°C, 85% RH
Accessories	GB wiring leads: GHT-109 x1 (only for GSB-02) HV wiring leads: GHT-108 x1 Power cord x1 Quick start guide x1 User manual x1 (CD) RS232C cable: GTL-235 HV test leads: GHT-116R x8(GSB-01), x6(GSB-02) Return test leads: GHT-116B x1 GB H test leads: GTL-116R x2(GSB-02) GB L test leads: GTL-116B x1(GSB-02)
Dimensions	GSB-01: 330(W) x 101(H) x 399(D) GSB-02: 330(W) x 101(H) x 413(D)
Weight	Approx. 5.5kgs



Note

When using the scanner box outputs, IR tests support a maximum of 2000MΩ.

# Dimensions

## GSB-01

---

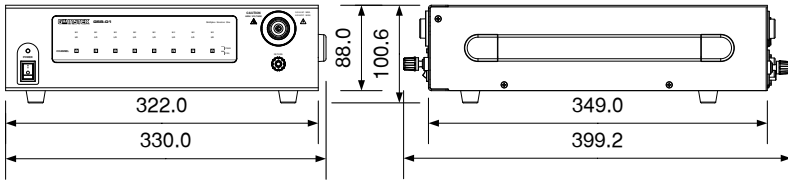
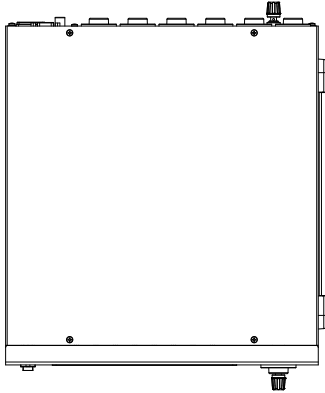

**GSB-02**

---

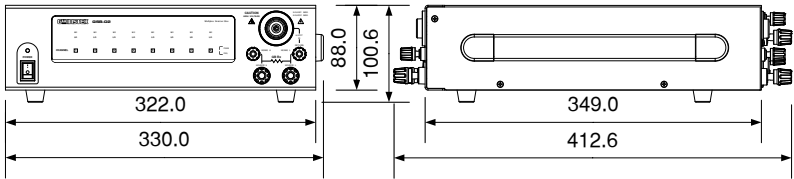
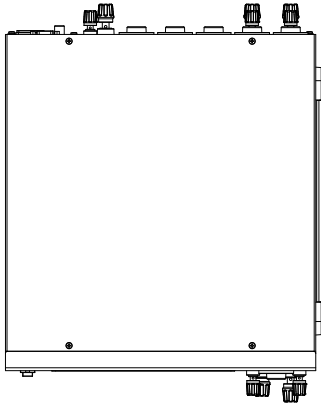

## Declaration of Conformity

We

**GOOD WILL INSTRUMENT CO., LTD.**

No. 7-1, Jhongsing Rd, Tucheng Dist., New Taipei City 236, Taiwan

**GOOD WILL INSTRUMENT (SUZHOU) CO., LTD.**

No. 69 Lushan Road, Suzhou New District Jiangsu, China.

declare that the below mentioned product

**Type of Product: Multiplex Scanner Box**

**Model Number: GSB-01, GSB-02**

are herewith confirmed to comply with the requirements set out in the Council Directive on the Approximation of the Law of Member States relating to Electromagnetic Compatibility (2004/108/EC) and Low Voltage Directive (2006/95/EC).

For the evaluation regarding the Electromagnetic Compatibility and Low Voltage Directive, the following standards were applied:

© EMC	
EN 61326-1 EN 61326-2-1	Electrical equipment for measurement, control and laboratory use -- EMC requirements (2013)
Conducted Emission Radiated Emission EN55011: 2009+A1: 2010	Electrostatic Discharge EN 61000-4-2: 2009
Current Harmonics EN 61000-3-2: 2006 +A1:2009 +A2:2009	Radiated Immunity EN 61000-4-3: 2006 +A2:2010
Voltage Fluctuations EN 61000-3-3: 2008	Electrical Fast Transients EN 61000-4-4: 2012
-----	Surge Immunity EN 61000-4-5: 2006
-----	Conducted Susceptibility EN 61000-4-6: 2009
-----	Power Frequency Magnetic Field EN 61000-4-8: 2010
-----	Voltage Dip/ Interruption EN 61000-4-11: 2004

Low Voltage Equipment Directive 2006/95/EC	
Safety Requirements	EN 61010-1: 2010 EN 61010-2-030: 2010

# INDEX

Accessories .....	11	test configuration.....	40
Automatic test		test results .....	48
create.....	51	test selection .....	35, 36, 38
overview .....	51	workflow.....	38
results .....	58	Marketing	
running a test .....	54	contact .....	72
Caution symbol.....	4	Menu tree.....	24
Cleaning the instrument .....	6	Operating precautions.....	20
Declaration of conformity.....	78	Output connections .....	32
Dimensions.....	76, 77	Overview.....	10
Disposal instructions.....	7	Power on/off	
DUT connections .....	32	safety instruction.....	5
EN61010		Rear panel diagram .....	16
measurement category .....	5	Safety considerations.....	18
pollution degree.....	6	Service operation	
Environment		about disassembly .....	5
safety instruction .....	6	contact .....	72
FAQ .....	71	Specifications .....	75
<b>Firmware note</b> .....	10	Test errors .....	74
Front panel diagram.....	13	Test lead connections	
Ground		GSB-01 .....	25
symbol.....	4	GSB-02.....	29
List of features.....	11	UK power cord.....	8
Manual tests		Utility settings	
creating.....	37	scanner interface.....	63
running a test .....	44	Warning symbol.....	4
scanner box configuration.....	41	Workplace precautions .....	18