

# Digital Storage Oscilloscope

GDS-1000A Series

---

## USER MANUAL

GW INSTEK PART NO. 82DS-1102AMA1

July 2009 edition

This manual contains proprietary information, which is protected by copyright. All rights are reserved. No part of this manual may be photocopied, reproduced or translated to another language without prior written consent of Good Will Corporation.

The information in this manual was correct at the time of printing. However, Good Will continues to improve its products and therefore reserves the right to change the specifications, equipment, and maintenance procedures at any time without notice.



ISO-9001 CERTIFIED MANUFACTURER

**GW INSTEK**

Good Will Instrument Co., Ltd.  
No. 7-1, Jhongsing Rd., Tucheng City, Taipei County 236, Taiwan.

# Table of Contents

**SAFETY INSTRUCTIONS..... 7**  
 Safety Symbols ..... 7  
 Safety Guidelines ..... 8  
 Power cord for the United Kingdom..... 10

**GETTING STARTED ..... 11**  
 Main Features ..... 11  
 Panel Overview..... 13  
     Front Panel..... 13  
     Rear Panel ..... 17  
     Display..... 18  
 Setting up the Oscilloscope..... 19

**QUICK REFERENCE ..... 22**  
 Menu Tree and Shortcuts..... 22  
     CH1/2 key..... 23  
     Cursor key 1/2..... 24  
     Cursor key 2/2..... 24  
     Display key ..... 25  
     Autoset key..... 25  
     Hardcopy key ..... 25  
     Help key..... 25  
     Horizontal menu key ..... 26  
     Math key 1/2 (+/-/x) ..... 26  
     Math key 2/2 (FFT/FFT rms) ..... 27  
     Measure key ..... 28  
     Run/Stop key..... 28  
     Save/Recall key 1/10..... 29  
     Save/Recall key 2/10..... 29  
     Save/Recall key 3/10..... 30  
     Save/Recall key 4/10..... 30  
     Save/Recall key 5/10..... 31  
     Save/Recall key 6/10..... 31  
     Save/Recall key 7/10..... 32  
     Save/Recall key 8/10..... 32  
     Save/Recall key 9/10..... 33  
     Save/Recall key 10/10..... 33  
     Trigger key 1/6 ..... 34

Trigger key 2/6 ..... 34  
 Trigger key 3/6 ..... 35  
 Trigger key 4/6 ..... 35  
 Trigger key 5/6 ..... 36  
 Trigger key 6/6 ..... 36  
 Utility key 1/6 ..... 37  
 Utility key 2/6 ..... 37  
 Utility key 3/6 ..... 38  
 Utility key 4/6 ..... 38  
 Utility key 5/6 ..... 39  
 Utility key 6/6 ..... 39

Default Settings..... 40  
 Built-in Help..... 41

**MEASUREMENT ..... 42**  
 Basic Measurements ..... 42  
     Activating a channel ..... 42  
     Using Autoset ..... 43  
     Running and stopping the trigger ..... 44  
     Changing the horizontal position and scale ..... 45  
     Changing the vertical position and scale ..... 46  
     Using the probe compensation signal ..... 47  
 Automatic Measurements..... 49  
     Measurement items ..... 49  
     Automatically measuring the input signals ..... 51  
 Cursor Measurements ..... 54  
     Using the horizontal cursors ..... 54  
     Using the vertical cursors ..... 55  
 Math Operations ..... 57  
     Overview..... 57  
     Adding, subtracting or multiplying signals..... 58  
     Using the FFT function..... 59

**CONFIGURATION ..... 61**  
 Acquisition ..... 61  
     Selecting the acquisition mode ..... 61  
     Selecting Delay mode..... 63  
     Real time vs Equivalent time sampling mode ..... 65  
 Display ..... 66  
     Selecting vector or dot drawing ..... 66  
     Accumulating the waveform ..... 66  
     Adjusting the display contrast ..... 67

Selecting the display grid .....	67
Horizontal View .....	68
Moving the waveform position horizontally .....	68
Selecting the horizontal scale .....	68
Selecting the waveform update mode .....	69
Zooming the waveform horizontally .....	70
Viewing waveforms in the X-Y mode .....	71
Vertical View (Channel) .....	72
Moving the waveform position vertically .....	72
Selecting the vertical scale .....	72
Selecting the coupling mode .....	72
Expand Vertical Scale Center / Ground .....	73
Inverting the waveform vertically .....	74
Limiting the waveform bandwidth .....	75
Selecting the probe attenuation level .....	75
Trigger .....	77
Trigger type .....	77
Trigger parameter .....	77
Configuring Holdoff .....	79
Configuring the edge trigger .....	80
Configuring the video trigger .....	81
Configuring the pulse width trigger .....	82
Manually triggering the signal .....	84
USB Port Interface .....	85
Remote Control Interface .....	86
System Settings .....	88
Viewing the system information .....	88
Selecting the language .....	88
<b>SAVE/RECALL .....</b>	<b>90</b>
File Structures .....	90
Display image file format .....	90
Waveform file format .....	90
Setup file format .....	93
Using the SD card file utilities .....	94
Quick Save (HardCopy) .....	97
Save .....	99
File type/source/destination .....	99
Saving the panel settings .....	100
Saving the waveform .....	101
Saving the display image .....	102
Saving all (panel settings, display image, waveform) .....	103







Recall .....	106
File type/source/destination .....	106
Recalling the default panel settings .....	107
Recalling a reference waveform to the display .....	108
Recalling panel settings .....	108
Recalling a waveform .....	109
Recall Image .....	111
<b>PRINT .....</b>	<b>113</b>
Print (Hardcopy) .....	113
<b>MAINTENANCE .....</b>	<b>115</b>
Vertical Resolution Calibration .....	115
Probe Compensation .....	116
<b>FAQ .....</b>	<b>118</b>
The input signal does not appear in the display .....	118
I want to remove some contents from the display .....	118
The waveform does not update (frozen) .....	119
The probe waveform is distorted .....	119
Autoset does not catch the signal well .....	119
I want to clean up the cluttered panel settings .....	119
The saved display image is too dark on the background .....	119
The accuracy does not match the specifications .....	120
The SD card slot does not accept my card .....	120
The oscilloscope will not allow a 2M waveform to be saved .....	120
<b>APPENDIX .....</b>	<b>121</b>
Fuse Replacement .....	121
GDS-1000A Series Specifications .....	122
Model-specific specifications .....	122
Common specifications .....	123
Probe Specifications .....	125
GDS-1062A/1102A/1152A Probe .....	125
EC Declaration of Conformity .....	126
<b>INDEX .....</b>	<b>127</b>

# S SAFETY INSTRUCTIONS

This chapter contains important safety instructions that should be followed when operating and storing the oscilloscope. Read the following before any operation to ensure your safety and to keep the oscilloscope in the best condition.

## Safety Symbols

These safety symbols may appear in this manual or on the oscilloscope.

-  **WARNING** Warning: Identifies conditions or practices that could result in injury or loss of life.
-  **CAUTION** Caution: Identifies conditions or practices that could result in damage to the oscilloscope or to other objects or property.
-  **DANGER High Voltage**
-  **Attention: Refer to the Manual**
-  **Protective Conductor Terminal**
-  **Earth (Ground) Terminal**

## Safety Guidelines

### General Guideline



- Make sure the BNC input voltage does not exceed 300V peak.
- Never connect a hazardous live voltage to the ground side of the BNC connectors. It might lead to fire and electric shock.
- Do not place heavy objects on the oscilloscope.
- Avoid severe impact or rough handling that may damage the oscilloscope.
- Avoid discharges of static electricity on or near the oscilloscope.
- Use only mating connectors, not bare wires, for the terminals.
- Do not block the cooling fan vent.
- Do not perform measurements at power sources and building installation sites (Note below).
- The oscilloscope should only be disassembled by a qualified technician.

(Measurement categories) EN 61010-1:2001 specifies the measurement categories and their requirements as follows. The GDS-1000A falls under category II.

- Measurement category IV is for measurement performed at the source of a low-voltage installation.
- Measurement category III is for measurement performed in a building installation.
- Measurement category II is for measurement performed on circuits directly connected to a low voltage installation.
- Measurement category I is for measurements performed on circuits not directly connected to Mains.

### Power Supply



- AC Input voltage: 100 ~ 240V AC, 47 ~ 63Hz
- The power supply voltage should not fluctuate more than 10%.
- Connect the protective grounding conductor of the AC power cord to an earth ground.

- Fuse
- Fuse type: T1A/250V
-  **WARNING**
- To ensure fire protection, replace the fuse only with the specified type and rating.
  - Disconnect the power cord before replacing the fuse.
  - Make sure the cause of fuse blowout is fixed before replacing the fuse.

- Cleaning the oscilloscope
- Disconnect the power cord before cleaning the oscilloscope.
  - Use a soft cloth dampened in a solution of mild detergent and water. Do not spray any liquid into the oscilloscope.
  - Do not use chemicals containing harsh products such as benzene, toluene, xylene, and acetone.

- Operation Environment
- Location: Indoor, no direct sunlight, dust free, almost non-conductive pollution (Note below)
  - Relative Humidity: < 80%
  - Altitude: < 2000m
  - Temperature: 0°C to 50°C
- (Pollution Degree) EN 61010-1:2001 specifies pollution degrees and their requirements as follows. The oscilloscope falls under degree 2.
- Pollution refers to “addition of foreign matter, solid, liquid, or gaseous (ionized gases), that may produce a reduction of dielectric strength or surface resistivity”.
- Pollution degree 1: No pollution or only dry, non-conductive pollution occurs. The pollution has no influence.
  - Pollution degree 2: Normally only non-conductive pollution occurs. Occasionally, however, a temporary conductivity caused by condensation must be expected.
  - Pollution degree 3: Conductive pollution occurs, or dry, non-conductive pollution occurs which becomes conductive due to condensation which is expected. In such conditions, equipment is normally protected against exposure to direct sunlight, precipitation, and full wind pressure, but neither temperature nor humidity is controlled.

- Storage environment
- Location: Indoor
  - Relative Humidity: < 85%
  - Temperature: -10°C to 60°C

**Power cord for the United Kingdom**

When using the oscilloscope in the United Kingdom, make sure the power cord meets the following safety instructions.

**NOTE:** This lead/appliance must only be wired by competent persons

 **WARNING: THIS APPLIANCE MUST BE EARTHED**  
**IMPORTANT:** The wires in this lead are coloured in accordance with the following code:

- Green/ Yellow: Earth
- Blue: Neutral
- Brown: Live (Phase)



As the colours of the wires in main leads may not correspond with the coloured marking identified in your plug/appliance, proceed as follows:

The wire which is coloured Green & Yellow must be connected to the Earth terminal marked with either the letter E, the earth symbol ⊕ or coloured Green/Green & Yellow.

The wire which is coloured Blue must be connected to the terminal which is marked with the letter N or coloured Blue or Black.

The wire which is coloured Brown must be connected to the terminal marked with the letter L or P or coloured Brown or Red.

If in doubt, consult the instructions provided with the equipment or contact the supplier.

This cable/appliance should be protected by a suitably rated and approved HBC mains fuse: refer to the rating information on the equipment and/or user instructions for details. As a guide, a cable of 0.75mm<sup>2</sup> should be protected by a 3A or 5A fuse. Larger conductors would normally require 13A types, depending on the connection method used.

Any exposed wiring from a cable, plug or connection that is engaged in a live socket is extremely hazardous. If a cable or plug is deemed hazardous, turn off the mains power and remove the cable, any fuses and fuse assemblies. All hazardous wiring must be immediately destroyed and replaced in accordance to the above standard.

# GETTING STARTED

The Getting started chapter introduces the oscilloscope's main features\*, appearance, and set up procedure. \* firmware V1.5.

## Main Features

Model name	Frequency bandwidth	Input channels
GDS-1062A	DC – 60MHz (-3dB)	2
GDS-1102A	DC – 100MHz (-3dB)	2
GDS-1152A	DC – 150MHz (-3dB)	2
Performance	<ul style="list-style-type: none"> <li>• 1 GS/s real-time sampling rate</li> <li>• 25GS/s equivalent-time sampling rate</li> <li>• 2M points record length</li> <li>• Up to 10ns peak detection</li> <li>• 2mV~10V vertical scale</li> <li>• 1ns ~ 50s time scale</li> </ul>	
Features	<ul style="list-style-type: none"> <li>• 5.6 inch color TFT display</li> <li>• Saving and recalling setups and waveforms</li> <li>• 27 automatic measurements</li> <li>• Multi-language menu (12 languages)</li> <li>• Math operation: Addition, Subtraction, multiplication, FFT, FFT RMS</li> <li>• Edge, video, pulse width trigger</li> <li>• Compact size: (W) 310 x (D) 140 x (H) 142 mm</li> <li>• Probe factor from 1X~100X</li> </ul>	

- Interface
- SD/SDHC card interface for saving and recalling data
  - Calibration output
  - External trigger input
  - USB slave interface for remote control
  - PictBridge Printer compatible

## Panel Overview

### Front Panel

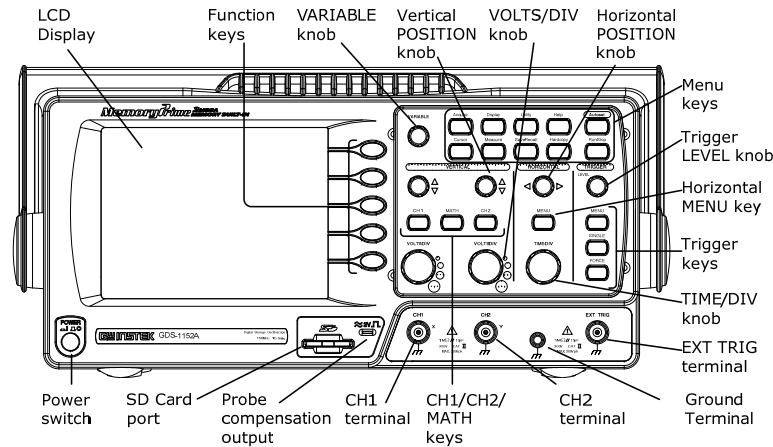

**LCD display** TFT color, 320 x 234 resolution, wide angle view LCD display.

**Function keys:** F1 (top) to F5 (bottom)  Activates the functions which appear in the left side of the LCD display.

**Variable knob**  **VARIABLE** Increases or decreases values and moves to the next or previous parameter.

**Acquire key**  **Acquire** Configures the acquisition mode (page61).

**Display key**  **Display** Configures the display settings (page66).

**Cursor key**  **Cursor** Runs cursor measurements (page54).

(Continued on next page)

**Utility key**  **Utility** Configures the Hardcopy function (page97), shows the system status (page84), selects the menu language (page88), runs the self calibration (page115), configures the probe compensation signal (page116), and selects the USB host type(page85).

**Help key**  **Help** Shows the Help contents on the display (page41).

**Autoset key**  **Autoset** Automatically configures the horizontal, vertical, and trigger settings according to the input signal (page43).

**Measure key**  **Measure** Configures and runs automatic measurements (page49).

**Save/Recall key**  **Save/Recall** Saves and recalls images, waveforms, or panel settings (page90).











**Hardcopy key**  **Hardcopy** Stores images, waveforms, or panel settings to an SD card (page97), or prints screen images to a PictBridge compatible printer (page113).

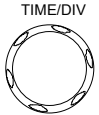

**Run/Stop key**  **Run/Stop** Runs or stops triggering (page44).

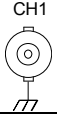
**Trigger level knob**  **TRIGGER LEVEL** Sets the trigger level (page77).

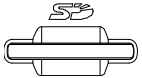
**Trigger menu key**  **MENU** Configures the trigger settings (page77).

**Single trigger key**  **SINGLE** Selects the single triggering mode (page84).

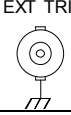
Trigger force key		Acquires the input signal once regardless of the trigger condition at the time (page84).
Horizontal menu key		Configures the horizontal view (page68).
Horizontal position knob		Moves the waveform horizontally (page68).
TIME/DIV knob		Selects the horizontal scale (page68).
Vertical position knob		Moves the waveform vertically (page72).
CH1/CH2 key		Configures the vertical scale and coupling mode for each channel (page72).
VOLTS/DIV knob		Selects the vertical scale (page72).
Input terminal		Accepts input signals: $1M\Omega \pm 2\%$ input impedance, BNC terminal.
Ground terminal		Accepts the DUT ground lead to achieve a common ground.
MATH key		Performs math operations (page57).
SD card port		Facilitates transferring waveform data, display images, and panel settings (page90).
Probe compensation output		Outputs a 2Vp-p, square signal for compensating the probe (page116) or demonstration.

External trigger input		Accepts an external trigger signal (page77).
Power switch		Powers the oscilloscope on or off.



**Rear Panel**

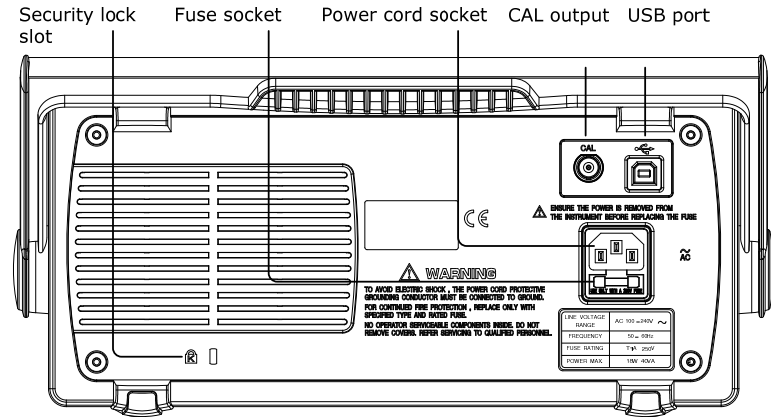

- Power cord socket

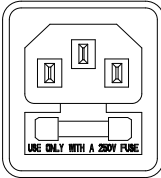

Power cord socket accepts the AC mains, 100 ~ 240V, 50/60Hz.
- Fuse socket



The fuse socket holds the AC main fuse, T1A/250V.  
For the fuse replacement procedure, see page121.
- USB slave port



Accepts a type B (slave) male USB connector for remote control of the oscilloscope (page85) or to print directly to a PictBridge compatible printer.
- Calibration output



Outputs the calibration signal used in vertical scale accuracy calibration (page115).
- Security lock slot



Standard laptop security lock slot for ensuring the security of the GDS-1000A.

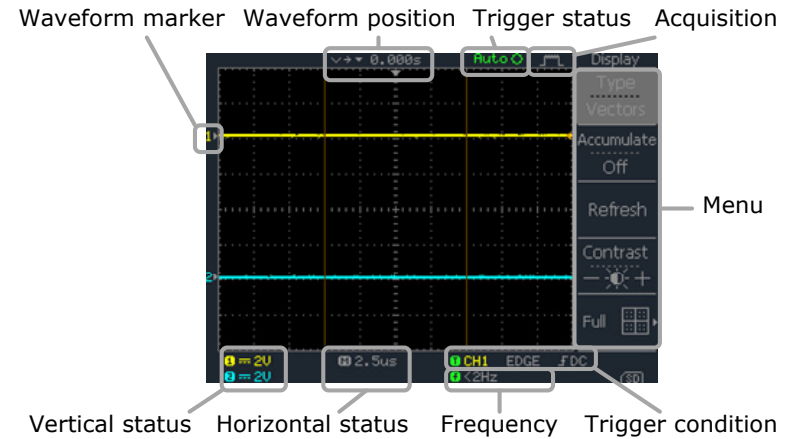

**Display**



Waveforms	Channel 1: Yellow	Channel 2: Blue
Trigger status	Trig'd	A signal is being triggered
	Trig?	Waiting for a trigger condition
	Auto	Updating the input signal regardless of trigger conditions
	STOP	Triggering is stopped
	For trigger setting details, see page77.	
Input signal frequency	Updates the input signal frequency (the trigger source signal) in real-time. “< 2Hz” Indicates that the signal frequency is less than the lower frequency limit (2Hz) and thus not accurate.	
Trigger configuration	Shows the trigger source, type, and slope. In case of the Video trigger, shows the trigger source and polarity.	
Horizontal status Vertical status	Shows the channel configurations: coupling mode, vertical scale, and horizontal scale.	

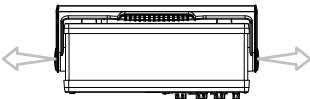
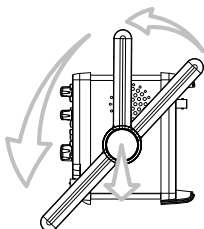
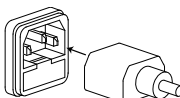

## Setting up the Oscilloscope

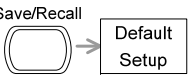
**Background** This section describes how to set up the oscilloscope properly including adjusting the handle, connecting a signal, adjusting the scale, and compensating the probe. Before operating the oscilloscope in a new environment, run these steps to make sure the oscilloscope is functionally stable.

- Procedure**
1. Pull both bases of the handle out slightly. 
  2. Turn to one of the three preset positions. 
  3. Connect the power cord. 
  4. Press the power switch. The display will become active in approximately 10 seconds. 
  5. Reset the system by recalling the factory settings. Press the Save/Recall key, then *Default Setup*. For details regarding the factory settings, see page40. 

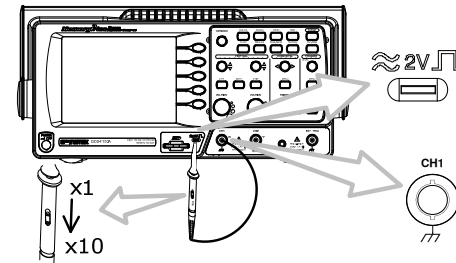
6. Connect the probe between the Channel1 input terminal and probe compensation signal output (2Vp-p, 1kHz square wave).
7. Set the probe attenuation to x10.

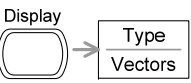

8. Press the Autoset key. A square waveform will appear in the center of the display. For details on Autoset, see page43. 
9. Press the Display key, then *Type* and select the vector waveform type.   

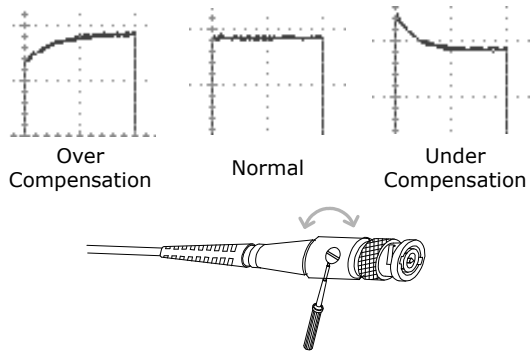
10. Turn the adjustment point on the probe to flatten the square waveform edge.



11. Setting up the oscilloscope is complete. You may continue with the other operations.  
 Measurement: page42 Configuration: page61

# QUICK REFERENCE

This chapter lists the oscilloscope menu tree, operation shortcuts, built-in help coverage, and default factory settings. Use this chapter as a handy reference to access the oscilloscope functionalities.

## Menu Tree and Shortcuts

Conventions	Examples
Normal	= Press the functional key for "Normal"
Average $\leftarrow$	= Repeatedly press the functional key for "Average"
Normal ~ Average	= Select a menu from "Normal" to "Average" and press its functionality key
Normal $\rightarrow$ VAR $\odot$	= Press the functionality key for "Normal", and then use the Variable knob

**Acquire**

Normal	●	2/ 4/ 8/ 16/ 32/ 64/ 128/ 256
Average	●	
Peak Detect	●	
Delay On	●	On/ Off
Sample Rate		500MS/s

Select acquisition mode  
Normal ~ Peak-Detect

Select average number  
Average ↵

Turn Delay on/off  
Delay On ↵

CH1/2 key

CH 1	●	Turn channel on/off CH 1/2 ↵
Coupling	●	~ / □ / ▸
Invert Off	●	On/ Off
BW Limit Off	●	On/ Off
Probe x1	●	x1/ x10/ x100
Expand Center	●	Center/Ground

Select coupling mode  
Coupling ↵

Invert waveform  
Invert ↵

Turn bandwidth limit on/off  
BW Limit ↵

Select probe attenuation  
↔Probe(1x~100x)

Expand type  
Expand ↵









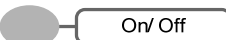

Cursor key 1/2

Cursor	●	Turn cursor on/off Cursor ↵
Source CH1	●	CH1/ 2/ MATH
X1 -5.000uS	●	Move X1 cursor X1 → VAR ↻
X2 5.000uS	●	Move X2 cursor X2 → VAR ↻
X1X2 Δ: 10.00uS F: 100.0kHz	●	Move both X1 and X2 cursor X1X2 → VAR ↻
X ↔ Y	●	Switch to Y cursor X ↔ Y

Cursor key 2/2

Cursor	●	Turn cursor on/off Cursor ↵
Source CH1	●	CH1/ 2/ MATH
Y1 123.4mV	●	Move Y1 cursor Y1 → VAR ↻
Y2 12.9mV	●	Move Y2 cursor Y2 → VAR ↻
Y1Y2 Δ: 10.5mV	●	Move both Y1 and Y2 cursor Y1Y2 → VAR ↻
X ↔ Y	●	Switch to X cursor X ↔ Y

**Display key**

		Select waveform type Type $\leftarrow$
Type Vectors		Waveform accumulate On/Off
Accumulate Off		Accumulate $\leftarrow$
Refresh		Refresh accumulation
Contrast - +		Refresh
Full 		Set display contrast
		Contrast $\rightarrow$ VAR $\odot$
		Select display grid
		$\leftarrow$

**Autoset key**

	Automatically find the signal and set the scale
	Autoset







**Hardcopy key**

Hardcopy 	$\rightarrow$ See Utility key (page36)
--	--







**Help key**

Help 	Turn help mode on/off
	Help $\leftarrow$

**Horizontal menu key**

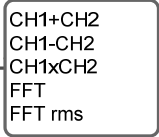
		Select main (default) display
Main		Main
Window		Select window mode
Window Zoom		Window $\rightarrow$ TIME/DIV $\odot$
Roll		Zoom in window mode
XY		Window Zoom
		Select window roll mode
		Roll
		Select XY mode
		XY

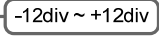
**Math key 1/2 (+/-/x)**

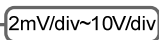
		Math on/off
Operation CH1+CH2		Math $\leftarrow$
		Select math operation type (+/-/x/FFT/FFT rms)
		Operation $\leftarrow$
Position 0.00 Div		Set result position
Unit/Div 2V		Position $\rightarrow$ VAR $\odot$
		Math result Volt/Div
		Unit/Div $\rightarrow$ VOLTS/DIV(CH2) $\odot$

Math key 2/2 (FFT/FFT rms)

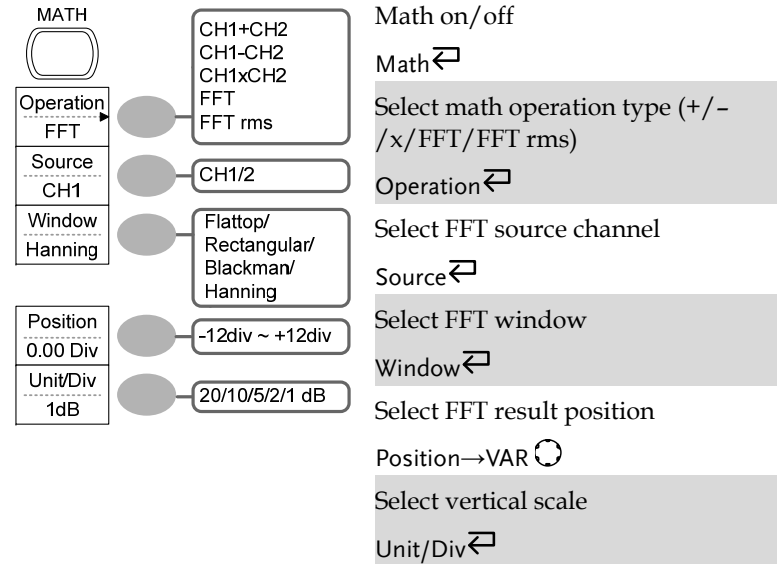

Measure key

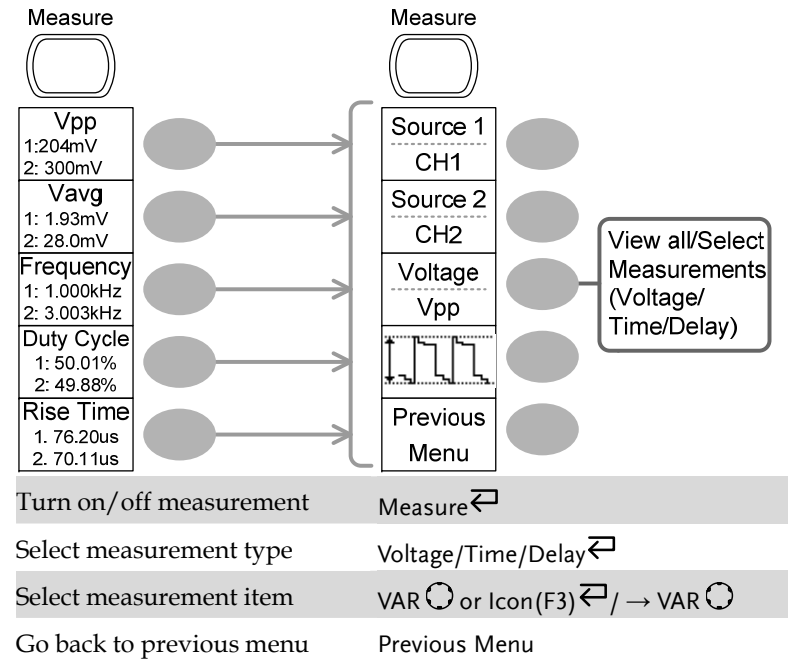

Run/Stop key

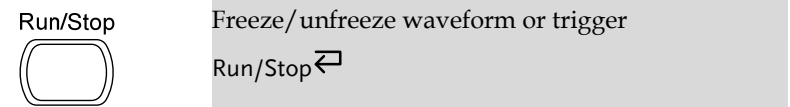

Save/Recall key 1/10

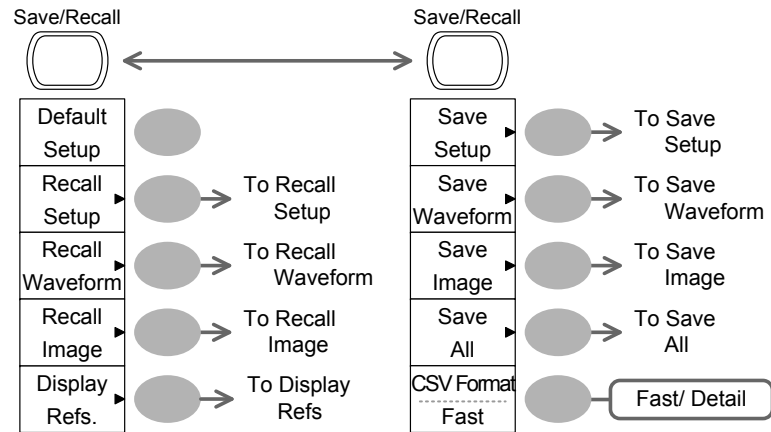

- Switch to Save or Recall menu Save/Recall ↵
- Recall default setup Default Setup
- Change CSV format CSV Format ↵

Save/Recall key 2/10

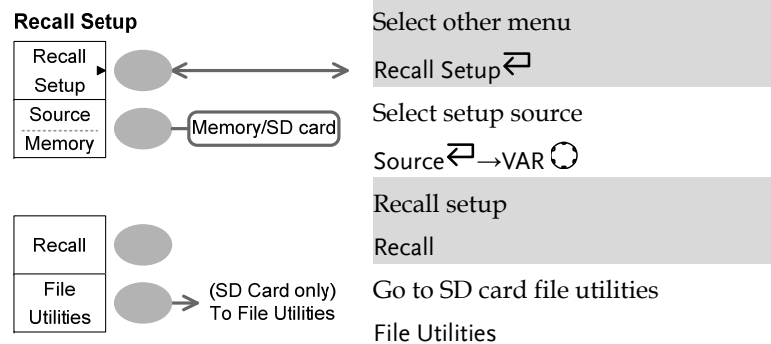

Save/Recall key 3/10

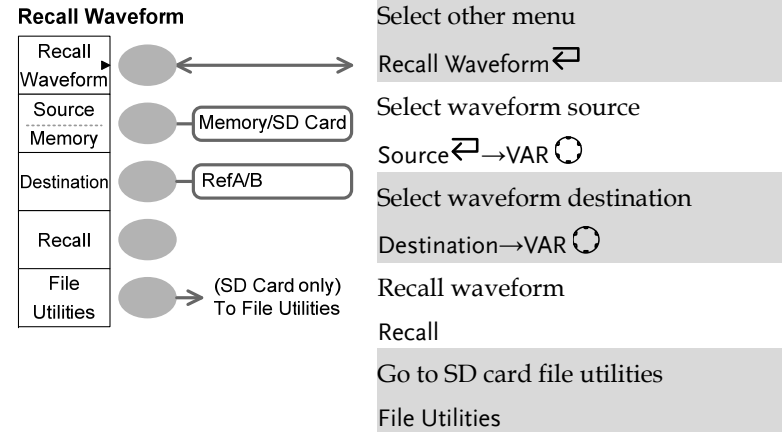

Save/Recall key 4/10

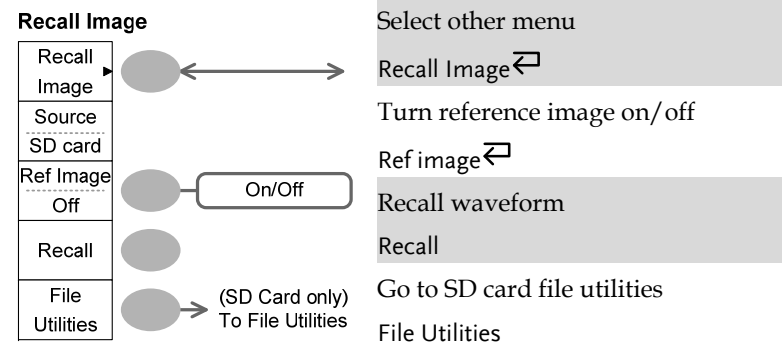

Save/Recall key 5/10

Display Refs.

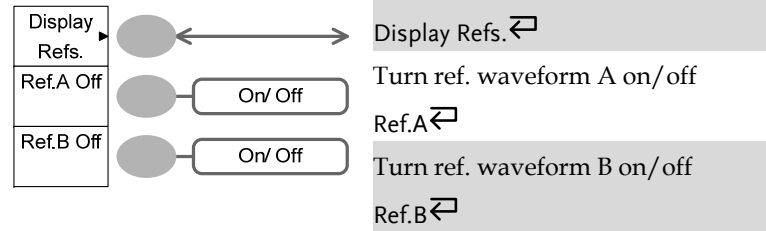

Save/Recall key 6/10

Save Setup

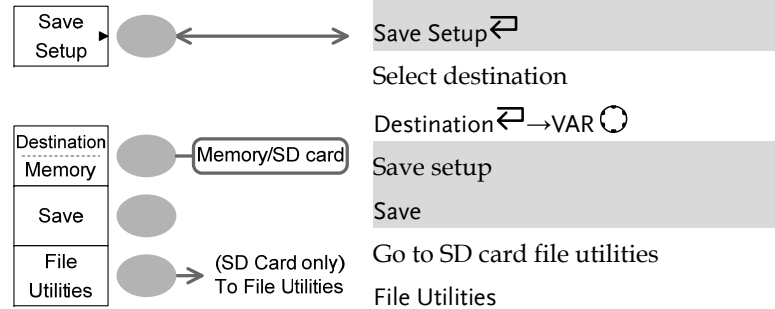

Save/Recall key 7/10

Save Waveform

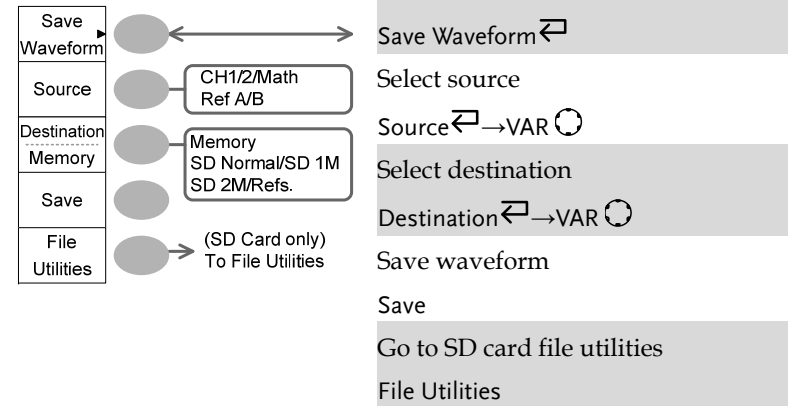

Save/Recall key 8/10

Save Image

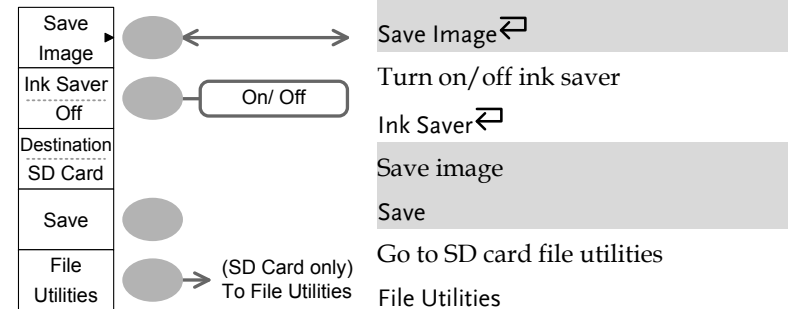



**Save/Recall key 9/10**

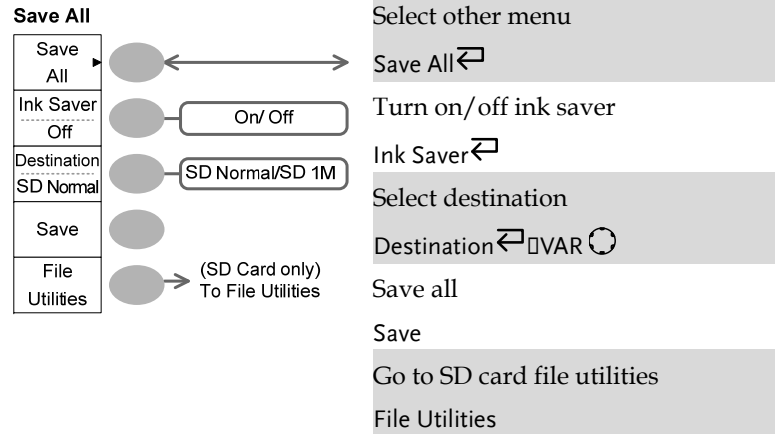

**Save/Recall key 10/10**

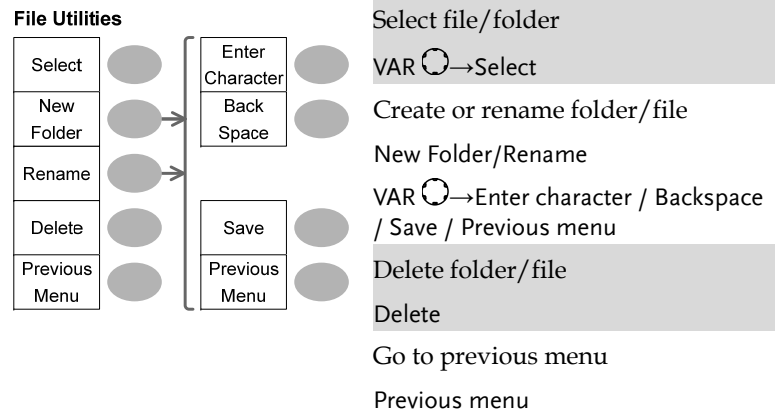

**Trigger key 1/6**

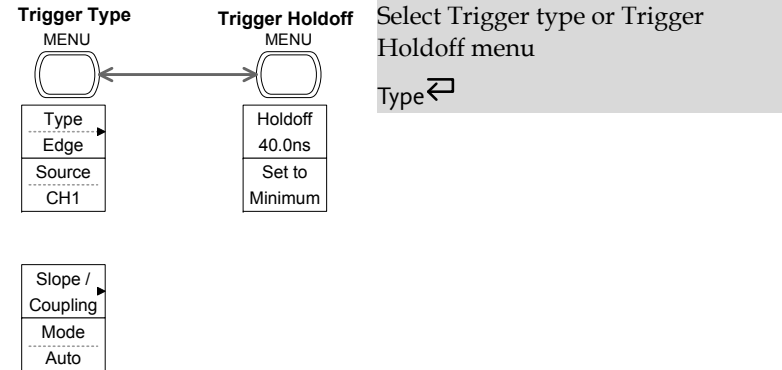

**Trigger key 2/6**

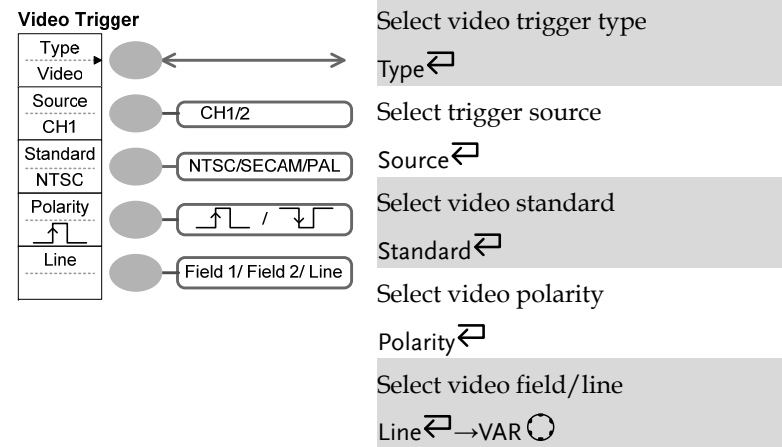

Trigger key 3/6

**Edge Trigger**

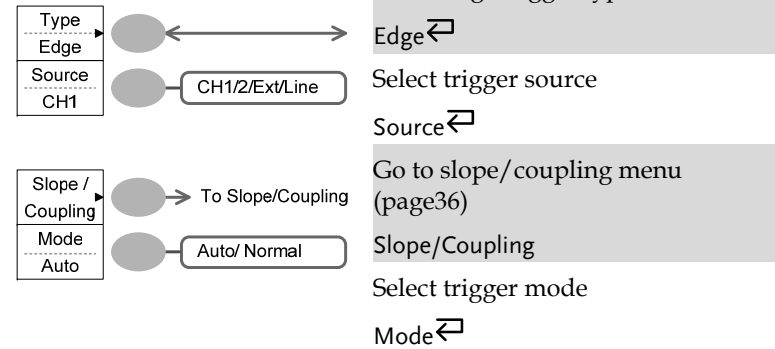

Trigger key 4/6

**Pulse Trigger**

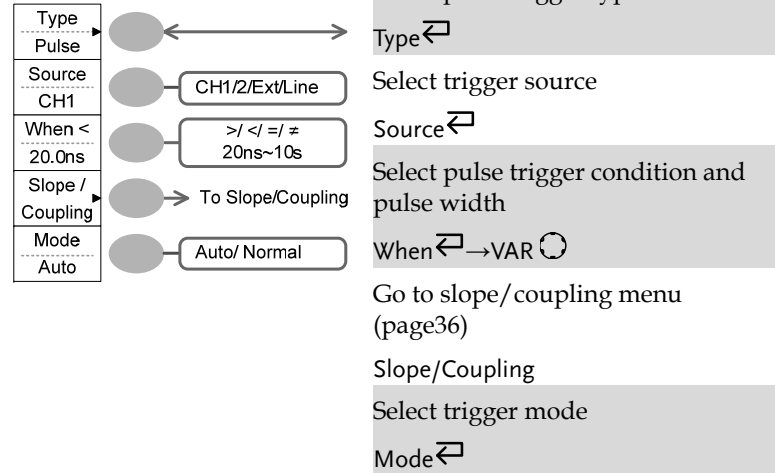

Trigger key 5/6

**Coupling/Slope**

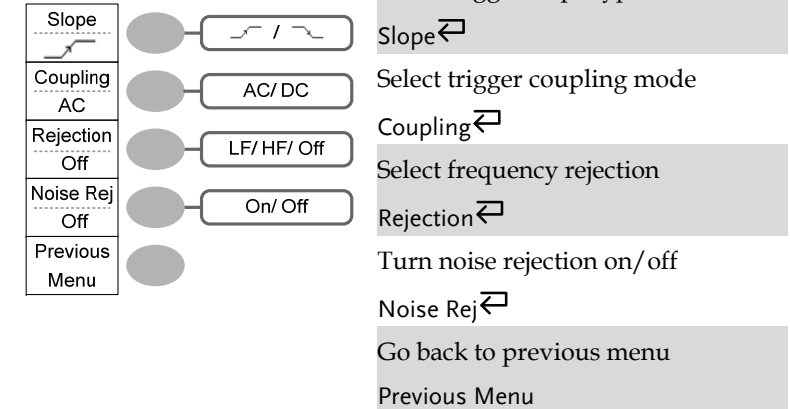

Trigger key 6/6

**Trigger Holdoff**

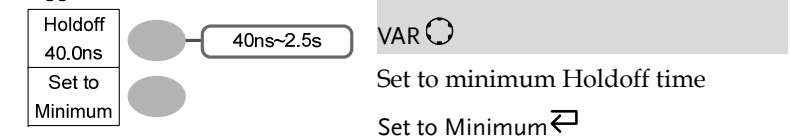

Utility key 1/6

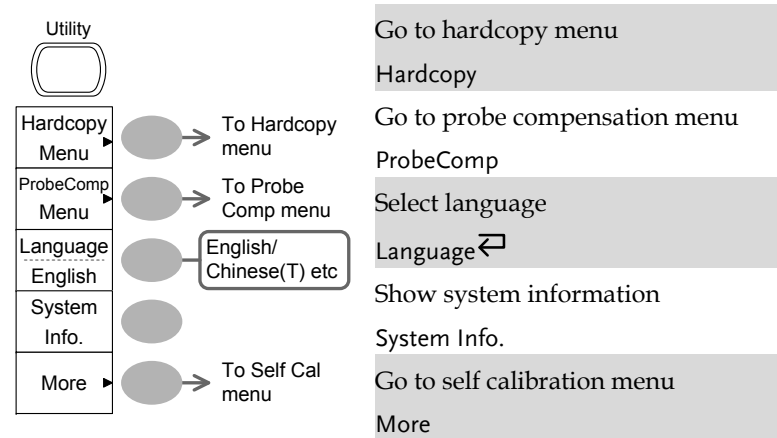

Utility key 2/6

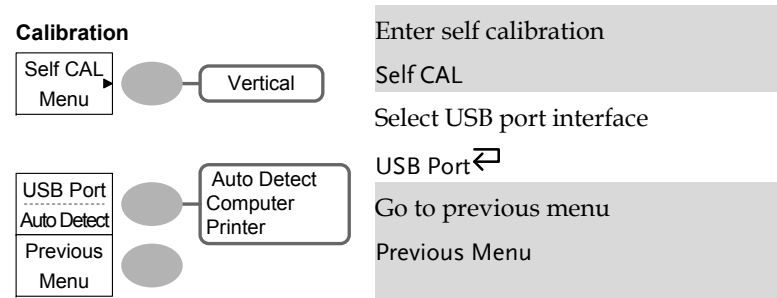

Utility key 3/6

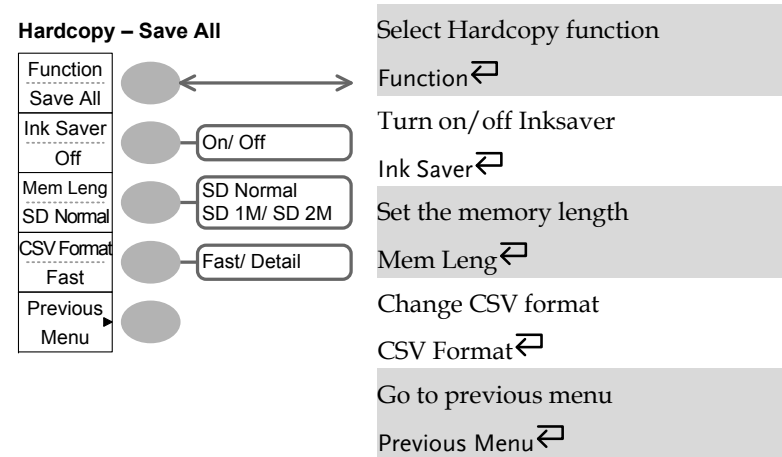

Utility key 4/6

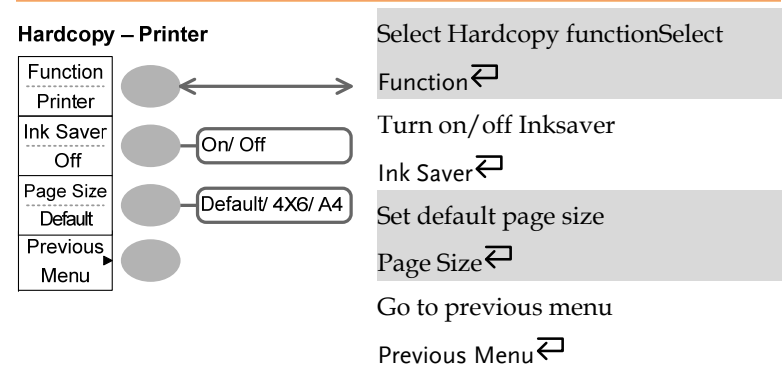

Utility key 5/6

**Hardcopy – Save Image**

Function	●	↔	Select Hardcopy function
Save Image	●		Function
Ink Saver	●	On/Off	Turn on/off Inksaver
Off	●		Ink Saver
Previous Menu	●		Go to previous menu
			Previous Menu

Utility key 6/6

**Probe compensation**

Wave Type	●	/	Select probe compensation signal
Frequency	●	(  only )	Wave Type
1 K	●	1k ~ 100k	Set frequency for square wave
Duty Cycle	●	(  only )	Frequency → VAR
50%	●	5% ~ 95%	Set duty cycle for square wave
Default	●		Duty Cycle → VAR
1kHz	●		Go to previous menu
Previous Menu	●		Previous Menu

Default Settings

Here are the factory installed panel settings which appear when pressing the Save/Recall key → → *Default Setup*.

Acquisition	Mode: Normal	
Channel	Scale: 2V/Div	Invert: Off
	Coupling: DC	Probe attenuation voltage: x1
	BW limit: Off	Channel 1 & 2: On
Cursor	Source: CH1	Cursor: Off
Display	Type: Vectors	Accumulate: Off
	Grid:	
Horizontal	Scale: 2.5us/Div	Mode: Main Timebase
Math	Type: + (Add)	Position: 0.00 Div
Measure	Item: Vpp, Vavg, Frequency, Duty Cycle, Rise Time	
Trigger	Type: Edge	Source: Channel1
	Mode: Auto	Slope:
	Coupling: DC	Rejection: Off
	Noise Rejection: Off	
Utility	Hardcopy: SaveImage, InkSaver Off	ProbeComp: Square wave, 1k, 50% duty cycle

## Built-in Help

The Help key shows the contents of the built-in help support. When you press a function key, its descriptions appear in the display.



Applicable keys

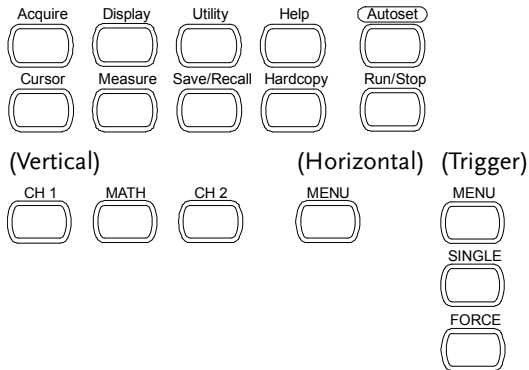

Procedure

1. Press the Help key. The display changes to the Help mode.
2. Press a functional key to access its help contents. (example: Acquire key)
3. Use the Variable knob to scroll the Help contents up and down.
4. Press the Help key again to exit the Help mode.



# M EASUREMENT

The Measurement chapter describes how to properly observe a signal using the oscilloscope's basic functions, and how to observe a signal in a detailed manner using some of the advanced functions such as :

Automatic measurements, cursor measurements, and math operations.

## Basic Measurements

This section describes the basic operations required in capturing and viewing an input signal. For more detailed operations, see the following chapters.

- Measurements → from page42
- Configurations → from page61

## Activating a channel

Activating a channel

To activate an input channel, press the Channel key, CH1 or CH2. The channel indicator appears at the left side of the display and the channel icon changes accordingly.

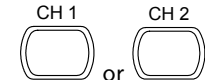

(Continued on next page)

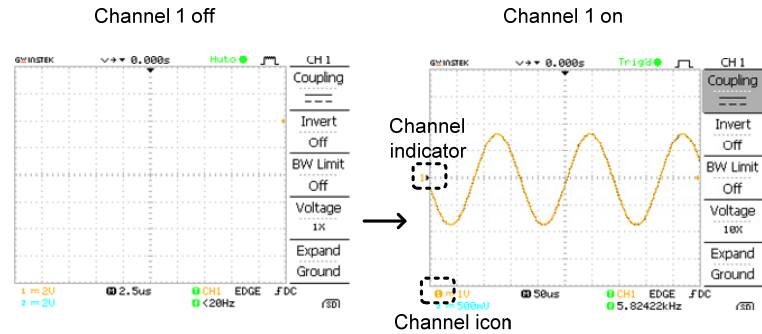

De-activating a channel To de-activate the channel, press the Channel key twice (once if the channel menu is already selected).

Using Autoset

Background The Autoset function automatically configures the panel settings to the best viewing conditions, in the following way.

- Selecting the horizontal scale
- Positioning the waveform horizontally
- Selecting the vertical scale
- Positioning the waveform vertically
- Selecting the trigger source channel
- Activating the channels

- Procedure
1. Connect the input signal to the oscilloscope and press the Autoset key. 
  2. The waveform appears in the center of the display.

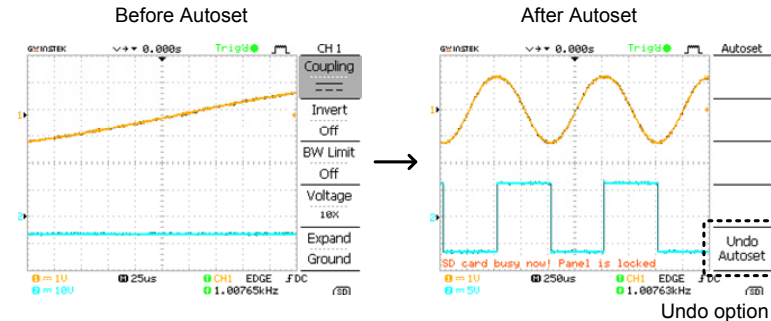

Undoing the Autoset To undo the Autoset, press *Undo* (available for a few seconds). 

Adjusting the trigger level If the waveform is still unstable, try adjusting the trigger level up or down by using the Trigger Level knob. 

Limitation Autoset does not work in the following situation.

- Input signal frequency less than 20Hz
- Input signal amplitude less than 30mV

Running and stopping the trigger

Background In the trigger Run mode, the oscilloscope constantly searches for a trigger condition and updates the signal into the display when the condition is met.

In the trigger Stop mode, the oscilloscope stops triggering and thus the last acquired waveforms stay in the display. The trigger icon at the top of the display changes into Stop mode.

Pressing the Trigger Run/Stop key  switches between the Run and Stop mode.

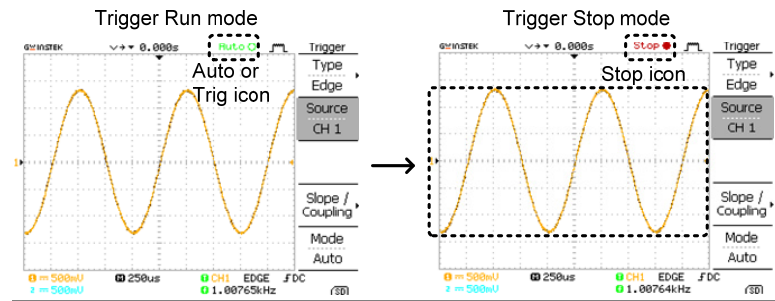

Waveform operation

Waveforms can be moved or scaled in both the Run and Stop mode. For details, see page68 (Horizontal position/scale) and page72 (Vertical position/scale).

### Changing the horizontal position and scale

For more detailed configurations, see page68.

Setting the horizontal position

The horizontal position knob moves the waveform left or right.  The position indicator moves along with the waveform and the distance from the center point is displayed as the offset in the upper side of the display.

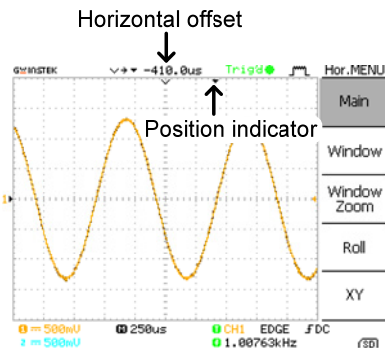

Selecting the horizontal scale

To select the timebase (scale), turn the TIME/DIV knob; left (slow) or right (fast).



Range 1ns/Div ~ 10s/Div, 1-2.5-5 increment

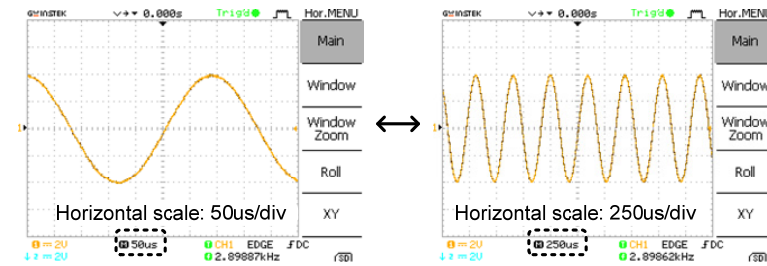

### Changing the vertical position and scale

For more detailed configuration, see page72.

Set vertical position

To move the waveform up or down, turn the vertical position knob for each channel. 

As the waveform moves, the vertical position of the cursor appears at the bottom left corner of the display.

Run/Stop mode The waveform can be moved vertically in both Run and Stop mode.

Select vertical scale

To change the vertical scale, turn the VOLTS/DIV knob; left (down) or right (up).



Range 2mV/Div ~ 10V/Div, 1-2-5 increments

The vertical scale indicator for each channel on the bottom left of the display changes accordingly.

Using the probe compensation signal

Background

This section introduces how to use the probe compensation signal for general usage, in case the DUT signal is not available or to get a second signal for comparison. For probe compensation details, see page116.



Note: The frequency accuracy and duty factor are not guaranteed. Therefore the signal should not be used for reference purposes.

Waveform type



Square waveform used for probe compensation. 1k ~ 100kHz, 5% ~ 95%.



Demonstration signal for showing the effects of peak detection. See page61 for peak detection mode details.

View the probe compensation waveform

1. Connect the probe between the compensation signal output and Channel input.

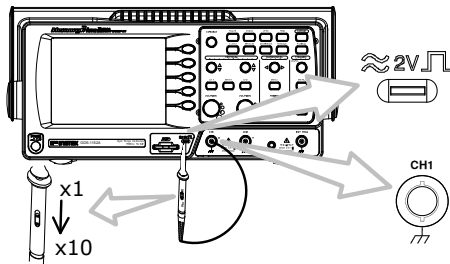

2. Press the Utility key.



3. Press *ProbeComp*.

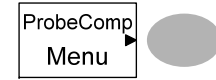

4. Press Wave type repeatedly to select the wave type.

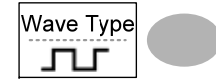

5. (For  $\square$  only) To change the frequency, press *Frequency* and use the Variable knob.

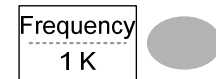

VARIABLE



Range 1kHz ~ 100kHz

6. (For  $\square$  only) To change the duty cycle, press *Duty Cycle* and use the Variable knob.

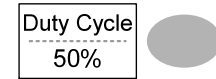

VARIABLE



Range 5% ~ 95%

Probe compensation

For probe compensation details, see page116.



## Automatic Measurements

The automatic measurement function measures input signal attributes and updates them in the display. Up to 5 automatic measurement items can be updated at any one time on the side menus. All automatic measurement types can be displayed on screen if necessary.

### Measurement items

Overview	Voltage type	Time type	Delay type
	Vpp	Frequency	FRR
	Vmax	Period	FRF
	Vmin	RiseTime	FFR
	Vamp	FallTime	FFF
	Vhi	+Width	LRR
	Vlo	-Width	LRF
	Vavg	Dutycycle	LFR
	Vrms		LFF
	ROVShoot		
	FOVShoot		
	RPREShoot		
	FPREShoot		
Voltage measurement items	Vpp	Difference between positive and negative peak voltage (=Vmax - Vmin)	
	Vmax	Positive peak voltage.	
	Vmin	Negative peak voltage.	
	Vamp	Difference between global high and global low voltage (=Vhi - Vlo)	
	Vhi	Global high voltage.	

Vlo		Global low voltage.
Vavg		Averaged voltage of the first cycle.
Vrms		RMS (root mean square) voltage.
ROVShoot		Rise overshoot voltage.
FOVShoot		Fall overshoot voltage.
RPREShoot		Rise preshoot voltage.
FPREShoot		Fall preshoot voltage.

Time measurement items	Time type	Description
	Freq	Frequency of the waveform.
	Period	Waveform cycle time (=1/Freq).
	Risetime	Rising time of the pulse (~90%).
	Falltime	Falling time of the pulse (~10%).
	+Width	Positive pulse width.
	-Width	Negative pulse width.
	Duty Cycle	Ratio of signal pulse compared with whole cycle =100x (Pulse Width/Cycle)
Delay measurement items	FRR	Time between: Source 1 first rising edge and Source 2 first rising edge

FRF		Time between: Source 1 first rising edge and Source 2 first falling edge
FFR		Time between: Source 1 first falling edge and Source 2 first rising edge
FFF		Time between: Source 1 first falling edge and Source 2 first falling edge
LRR		Time between: Source 1 first rising edge and Source 2 last rising edge
LRF		Time between: Source 1 first rising edge and Source 2 last falling edge
LFR		Time between: Source 1 first falling edge and Source 2 last rising edge
LFF		Time between: Source 1 first falling edge and Source 2 last falling edge

Automatically measuring the input signals

Viewing the measurement result

1. Press the Measure key.
2. The measurement results appear on the menu bar, constantly updated. 5 measurement slots (F1 to F5) can be customized.

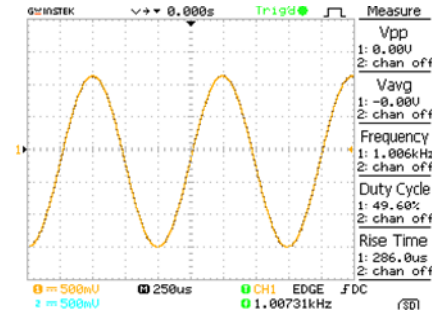

Editing a measurement item

3. Press the corresponding menu key (F1~F5) to select the measurement slot to be edited.



4. The editing menu appears

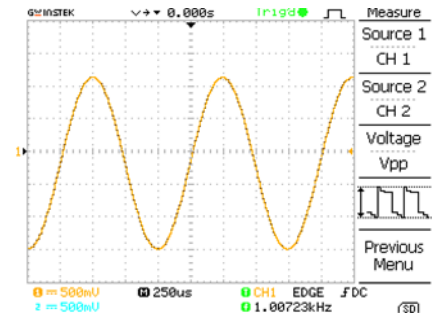

Change measurement item

5. Use the Variable knob to select a different measurement item.



Change measurement source

6. Press F1 repeatedly to change Source1 from CH1 to CH2 or MATH.

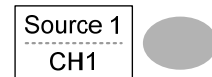

Range CH1, 2, Math

- Press *F2* repeatedly to change the channel for Source2.

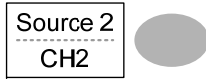

Range CH1, 2, Math

View all measurements

- Press *F3* to view all measurement items.



- All the measurements appear in the center of the screen.

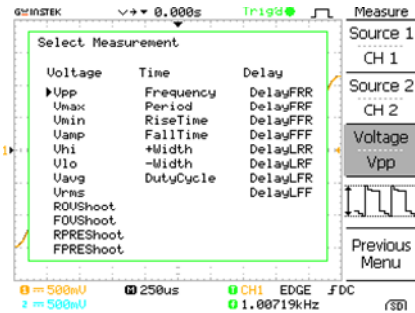

- Press *F3* to return.



Note: All the editing operations can still be performed when viewing all the measurement items.

- Press *Previous Menu* to confirm the item selection and to go back to the measurement results view.

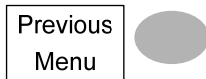

## Cursor Measurements

Cursor lines, horizontal or vertical, show the precise position of the input waveforms or the math operation results. The horizontal cursors can track time, voltage and frequency, whilst the vertical cursors can track voltage. All measurements are updated in real-time.

### Using the horizontal cursors

Procedure

- Press the Cursor key. The cursors appear in the display.



- Press *X↔Y* to select the horizontal (X1&X2) cursor.

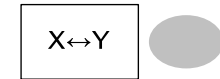

- Press *Source* repeatedly to select the source channel.

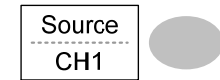





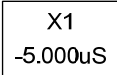

Range CH1, 2, MATH

- The cursor measurement results will appear in the menu, *F2* to *F4*.

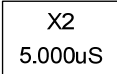
Parameters

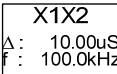



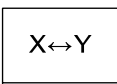
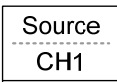

- |       |   |
|-------|---|
| X1    | Time position of the left cursor. (relative to zero)  |
| X2    | Time position of the right cursor. (relative to zero) |
| X1X2  | The difference between the X1 and X2.                 |
| Δ: us | The time difference between X1 and X2.                |
| f: Hz | The time difference converted to frequency.           |

Moving the horizontal cursors	To move the left cursor, press <i>X1</i> and then use the Variable knob.		
	To move the right cursor, press <i>X2</i> and then use the Variable knob.		
	To move both cursors at once, press <i>X1X2</i> and then use the Variable knob.		
Remove cursors	Press <i>Cursor</i> to remove the onscreen cursors.		

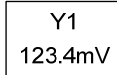
**Using the vertical cursors**

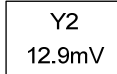
Procedure	1. Press the <i>Cursor</i> key.	
	2. Press <i>X↔Y</i> to select the vertical ( <i>Y1&amp;Y2</i> ) cursor.	
	3. Press <i>Source</i> repeatedly to select the source channel.	
	Range      CH1, 2, MATH	
4. The cursor measurement results will appear in the menu.		

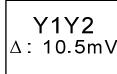
Parameters	<i>Y1</i>	Voltage level of the upper cursor
	<i>Y2</i>	Voltage level of the lower cursor
	<i>Y1Y2</i>	The difference between the upper and lower cursor
	$\Delta : V$	The voltage difference ( <i>Y1-Y2</i> ).

Moving the vertical cursors	To move the upper cursor, press <i>Y1</i> and then use the Variable knob.		
	To move the lower cursor, press <i>Y2</i> and then use the Variable knob.		
	To move both cursors at once, press <i>Y1Y2</i> and then use the Variable knob.		
Remove cursors	Press <i>Cursor</i> to remove the onscreen cursors.		

## Math Operations







The Math operations can add, subtract, multiply or perform FFT/FFT RMS on the input waveforms. The resulted waveform can be measured using the cursors, and saved or recalled just like normal input signals.

### Overview

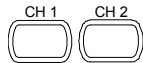

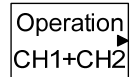
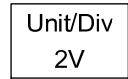



Addition (+)	Adds the amplitude of CH1 & CH2 signals.	
Subtraction (-)	Extracts the amplitude difference between CH1 & CH2.	
Multiplication (x)	Multiplies CH1 and CH2.	
FFT	Performs a FFT calculation on a signal. Four types of FFT windows are available: Hanning, Flattop, Rectangular, and Blackman.	
FFT RMS	Performs a FFT RMS calculation on a signal. RMS is similar to FFT, however the amplitude is calculated as RMS and not dB. Four types of FFT windows are available: Hanning, Flattop, Rectangular, and Blackman.	
Hanning FFT window	Frequency resolution	Good
	Amplitude resolution	Not good
	Suitable for...	Frequency measurement on periodic waveforms
Flattop FFT window	Frequency resolution	Not good
	Amplitude resolution	Good
	Suitable for...	Amplitude measurement on periodic waveforms
Rectangular FFT window	Frequency resolution	Very good
	Amplitude resolution	Bad

	Suitable for...	Single-shot phenomenon (this mode is the same as having no window at all)
Blackman FFT window	Frequency resolution	Bad
	Amplitude resolution	Very good
	Suitable for...	Amplitude measurement on periodic waveforms

### Adding, subtracting or multiplying signals

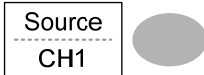
- |           |   |  |
|-----------|---|--|
| Procedure | 1. Activate both CH1 and CH2.   |   |
|           | 2. Press the Math key.  |   |
|           | 3. Press <i>Operation</i> repeatedly to select addition (+), subtraction (-) or multiplication (x).               |   |
|           | 4. The math measurement result appears in the display.  |    |
|           | 5. To move the math result vertically, use the Variable knob. The position will be displayed in <i>Position</i> . | <br> |
|           | 6. To clear the math result from the display, press the Math key again.   |   |

Using the FFT function

- Procedure
1. Press the Math key. 
  2. Press *Operation* repeatedly to select FFT or FFT RMS. 
  3. Press *Source* repeatedly to select the source channel. 
  4. Press *Window* repeatedly to select the FFT window type. 
  5. The FFT result appears. The horizontal scale changes from time to frequency, and the vertical scale from voltage to dB or RMS.
  6. To move the FFT waveform vertically, use the Variable knob. The position will be updated in *Position*.   
  
 Range      -12.00 Div ~ +12.00 Div
  7. To select the vertical scale of FFT waveform, press *Unit/Div*(FFT) or *Volt/Div*(FFT RMS) repeatedly.   
 Range      1, 2, 5, 10, 20 dB/Div  
 Voltage Volt/Div

8. To clear the FFT result from the display, press the Math  key again.









# CONFIGURATION

The Configuration chapter describes how to configure panel settings to make measurements and observations suited to the application needs.







## Acquisition

The acquisition process samples the analog input signals and converts them into digital format for internal processing. You may select the normal, average, or peak detect acquisition mode.

### Selecting the acquisition mode

Procedure	1. Press the Acquire key.						
	2. Select the acquisition mode between <i>Normal</i> , <i>Average</i> and <i>Peak Detect</i> .	<table border="1"> <tr> <td>Normal</td> <td></td> </tr> <tr> <td>Average</td> <td></td> </tr> <tr> <td>Peak Detect</td> <td></td> </tr> </table>	Normal		Average		Peak Detect
Normal							
Average							
Peak Detect							
Range	Normal	All of the acquired data is used to draw the waveform.					

Average	Multiple data is averaged to form a waveform. This mode is useful for drawing a noise-free waveform. To select the number, press <i>Average</i> repeatedly.  Average number: 2, 4, 8, 16, 32, 64, 128, 256
Peak detect	To activate the Peak detect mode, press <i>Peak-Detect</i> . Only the minimum and maximum value pairs for each acquisition interval (bucket) are used. This mode is useful for catching abnormal glitches in a signal.

Peak detect effect using the probe comp. waveform	1. One of the probe compensation waveforms can demonstrate the peak detection mode. Connect the probe to the probe compensation output.	
	2. Press the Utility key.	
	3. Press <i>ProbeComp</i> .	
	4. Press <i>Wave Type</i> and select the  waveform.	
	5. Press the Autoset key. The oscilloscope positions the waveform in the center of the display.	
	6. Press the Acquire key.	

7. Press *Normal*.



8. Press *Peak-Detect* and see that a spike noise is captured.

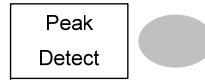

Example

The peak detect mode reveals the occasional glitch.

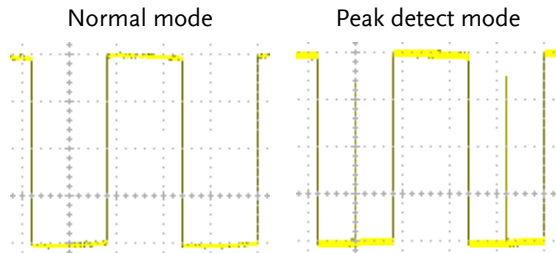

Selecting Delay mode

Background

When delay time is ON, the displayed output is delayed for a defined amount of time from the trigger point. Using the delay function is useful for observing an area of the waveform that occurs some time after the trigger point.

Delay On

With Delay On the expansion point and trigger point become separated by the amount of delay time. As the delay time is increased the trigger point moves left from the expansion point. When the horizontal scale is adjusted, the waveform expands from the expansion point, not the trigger point.

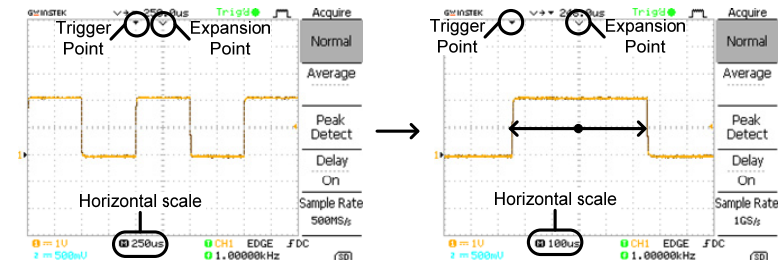

Delay Off

With Delay Off the expansion point and trigger point are always in the same position. Thus when the horizontal scale is adjusted, the waveform expands from the trigger point.

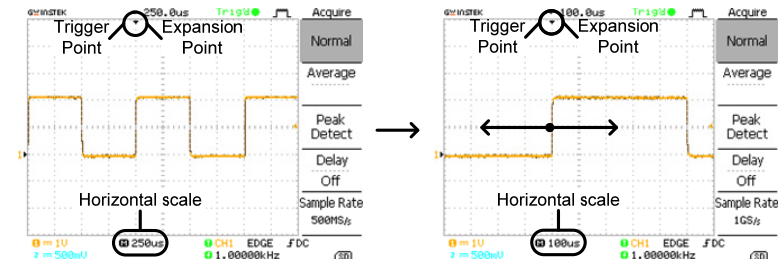

Procedure

1. Press the Acquire key.



2. Press *Delay On/Off* to toggle Delay On/Off.

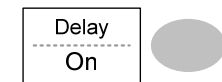

3. Use the Horizontal Position knob to increase or decrease the delay time when Delay is set to On.

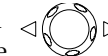

4. Adjust the horizontal scale to zoom into the waveform.





**Real time vs Equivalent time sampling mode**

Background	The oscilloscope automatically switches between two sampling modes, Real-time and Equivalent-time, according to the number of active channels and sampling rate.
Real-time sampling	Once sampled data is used to reconstruct a single waveform. Short-time events might get lost if the sampling rate gets too high. This mode is used when the sampling rate is relatively low (1GSa/s or lower).
Equivalent-time sampling	Multiple numbers of sampled data are accumulated to reconstruct a single waveform. ETS restores more waveform detail but takes longer to update the waveform. This mode is used when the sampling rate becomes higher than 1GSa/s. The maximum equivalent-time sampling rate is 25GSa/s.



**Display**

The Display section describes how to configure the display settings: drawing type, waveform accumulation, contrast adjustment, and grid settings.

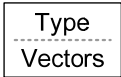
**Selecting vector or dot drawing**

Procedure	1. Press the Display key.	
	2. Press <i>Type</i> repeatedly to select the waveform drawing.	
Types	Dots	Only the sampled dots are displayed.
	Vectors	The sampled dots are connected by lines.

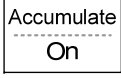
**Accumulating the waveform**

Background	Accumulation preserves the old waveform drawings and overwrites new waveforms on top of it. It is useful for observing waveform variation.	
Procedure	3. Press the Display key.	
	4. Press <i>Accumulate</i> to turn on the waveform accumulation.	
	5. To clear the accumulation and start it over (refresh), press <i>Refresh</i> .	

Example

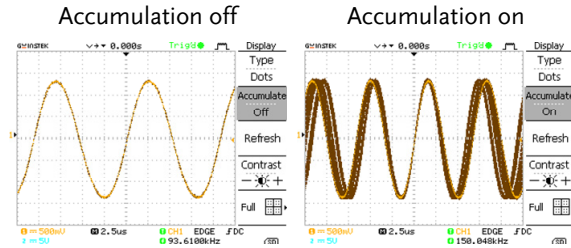

### Adjusting the display contrast

Procedure

1. Press the Display key.



2. Press Contrast.

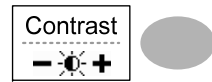

3. Turn the Variable knob left to lower the contrast (dark display) or right to raise the contrast (bright display).



### Selecting the display grid

Procedure

1. Press the Display key.



2. Press the grid icon repeatedly to select the grid.

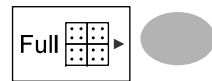

Parameters



Shows the full grid.



Shows the outer frame and X/Y axis.



Shows only the outer frame.

## Horizontal View

The Horizontal view section describes how to configure the horizontal scale, position, waveform update mode, window zoom, and X-Y mode.

### Moving the waveform position horizontally

Procedure

The horizontal position knob moves the waveform left or right. The position indicator at the top of the display shows the center and current position.

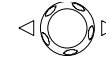

Center position

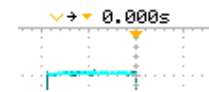

Moving right

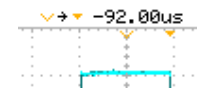

### Selecting the horizontal scale

Select horizontal scale

To select the timebase (scale), turn the TIME/DIV knob; left (slow) or right (fast).



Range 1ns/Div ~ 50s/Div, 1-2.5-5-10 increment

The timebase indicator at the bottom of the display updates the current horizontal scale.

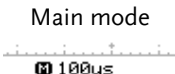
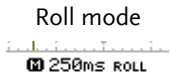

### Selecting the waveform update mode

Background	The display update mode is switched automatically or manually according to the horizontal scale.
Main mode	Updates the whole displayed waveform at once. The main mode is automatically selected when the horizontal scale (timebase) is fast. Horizontal scale $\leq 100\text{ms}/\text{div}$ Trigger All modes available
Roll mode	Updates and moves the waveform gradually from the right side of the display to the left. The Roll mode is automatically selected when the horizontal scale (timebase) is 250ms or greater. When in the Roll mode, an indicator appears at the bottom of the display. Main mode  Roll mode  Timebase $\geq 250\text{ms}/\text{div}$ ( $\leq 250\text{KS}/\text{s}$ ) Trigger Auto mode only

Selecting the Roll mode manually 1. Press the Horizontal menu key.



2. Press *Roll*. The horizontal scale automatically becomes 250ms/div and the waveform starts scrolling from the right side of the display (If the oscilloscope is already in the Roll mode, there will be no change).



### Zooming the waveform horizontally

Procedure/ range 1. Press the Horizontal Menu key.



2. Press *Window*.



3. Use the horizontal position knob to move the zoom range sideways, and TIME/DIV knob to change the zoom range width.



The width of the bar in the middle of the display is the actual zoomed area.

Zoom range 1ns ~ 25s

4. Press *Window Zoom*. The specified range gets zoomed.

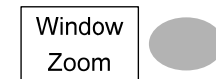

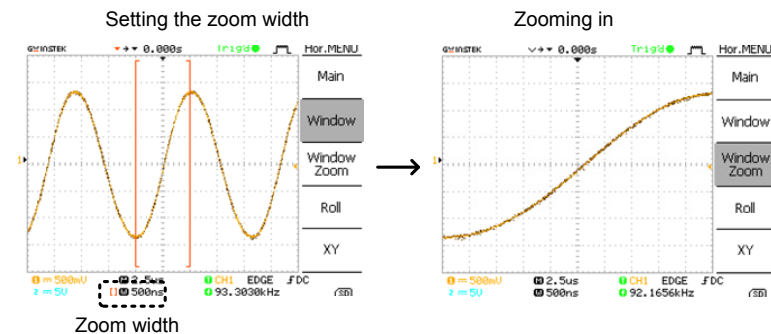

#### Example

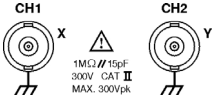
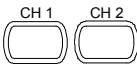

**Viewing waveforms in the X-Y mode**

**Background** The X-Y mode compares the voltage of Channel 1 and Channel 2 waveforms in a single display. This mode is useful for observing the phase relationship between the two waveforms.

- Procedure**
1. Connect the signals to Channel 1 (X-axis) and Channel 2 (Y-axis). 
  2. Make sure both Channel 1 and 2 are activated. 
  3. Press the Horizontal key. 
  4. Press XY. The display shows two waveforms in X-Y format; Channel 1 as X-axis, Channel 2 as Y-axis. 

Adjusting the X-Y mode waveform	Horizontal position	CH1 Position knob
	Horizontal scale	CH1 Volts/Div knob
	Vertical position	CH2 Position knob
	Vertical scale	CH2 Volts/Div knob

**Example**

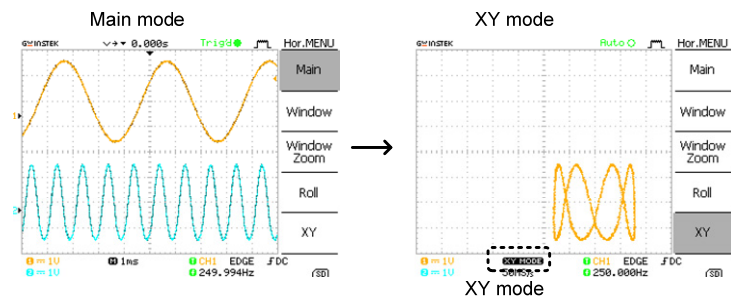

**Vertical View (Channel)**

The Vertical view section describes how to set the vertical scale, position, bandwidth limitation, coupling mode, and attenuation.

**Moving the waveform position vertically**

- Procedure** To move the waveform up or down, turn the vertical position knob for each channel. 



**Selecting the vertical scale**

- Procedure** To change the vertical scale, turn the VOLTS/DIV knob; left (down) or right (up). 

**Range** 2mV/Div ~ 10V/Div, 1-2-5 increments

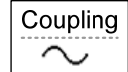
**Selecting the coupling mode**

- Procedure**
1. Press the Channel key. 
  2. Press *Coupling* repeatedly to select the coupling mode. 

- Range**
-  DC coupling mode. The whole portion (AC and DC) of the signal appears on the display.
  -  AC coupling mode. The display shows only the zero voltage level as a horizontal line. This mode is useful for measuring the signal amplitude with respect to the ground level.
  -  Ground coupling mode. The display shows only the zero voltage level as a horizontal line. This mode is useful for measuring the signal amplitude with respect to the ground level.



AC coupling mode. Only the AC portion of the signal appears on the display. This mode is useful for observing AC waveforms mixed with DC components.

### Expand Vertical Scale Center / Ground

#### Background

Normally when the vertical scale is increased, the scaled image is centered from ground. However a signal with a voltage bias could be obscured when the vertical scale is increased. The Expand Center function expands the image from the center of the signal, rather than ground.

#### Expand Ground

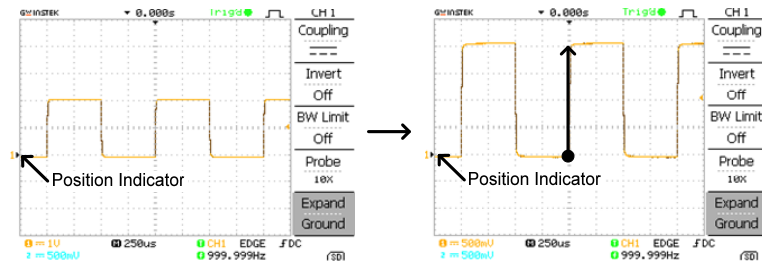

#### Expand Center

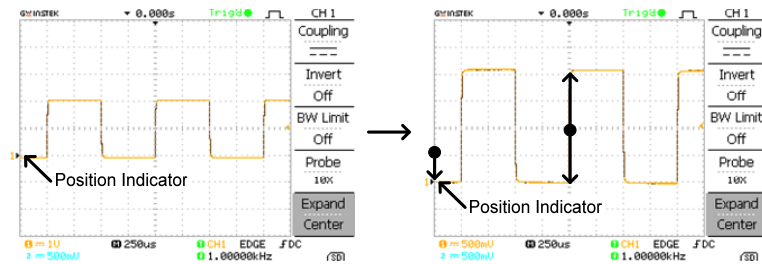

#### Procedure

1. Press the Channel key.



2. Press F5 to toggle between Expand Center and Expand Ground.



3. To change the vertical scale, turn the VOLTS/DIV knob; left (down) or right (up).



The vertical scale indicator on the bottom left of the display changes accordingly.

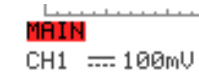

### Inverting the waveform vertically

#### Procedure

1. Press the Channel key.



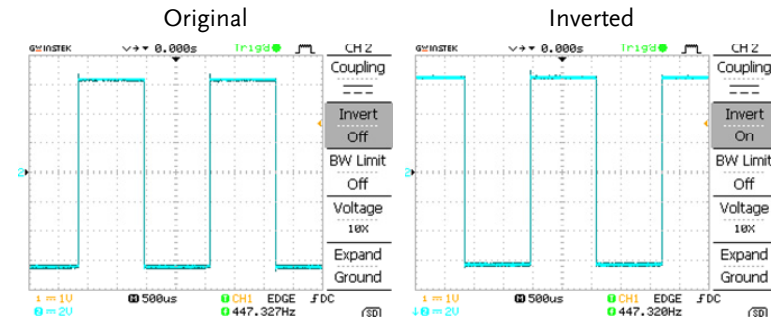
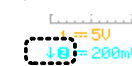
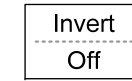

2. Press *Invert*. The waveform becomes inverted (upside down) and the Channel indicator in the display shows a down arrow.

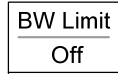

**Limiting the waveform bandwidth**

**Background** Bandwidth limitation puts the input signal into a 20MHz (-3dB) low-pass filter. This function is useful for cutting off high frequency noise to see the clear waveform shape.

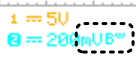

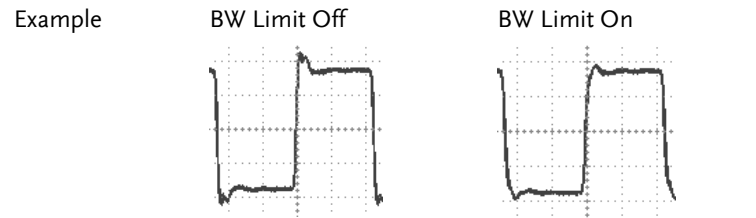
- Procedure**
1. Press the Channel key. 
  2. Press *BW Limit* to turn on or off the limitation. When turned on, the BW indicator appears next to the Channel indicator in the display.   



**Selecting the probe attenuation level**

**Background** A signal probe has an attenuation switch to lower the original DUT signal level to the oscilloscope input range, if necessary. The probe attenuation selection adjusts the vertical scale so that the voltage level on the display reflects the real value, not the attenuated level.

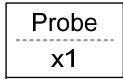
- Procedure**
1. Press the Channel key. 

2. Press *Probe* repeatedly to select the attenuation level.  
3. Use the variable knob to edit the voltage or current attenuation. 
4. The voltage scale in the channel indicator changes accordingly. There is no change in the waveform shape.

**Range** x1, x10, x100

 **Note:** The attenuation factor adds no influence on the real signal; it only changes the voltage scale on the display.

## Trigger

The Trigger function configures the conditions by which the oscilloscope captures the incoming signals.

### Trigger type

Edge	Triggers when the signal crosses an amplitude threshold in either a positive or negative slope.	
Video	Extracts a sync pulse from a video format signal and triggers on a specific line or field.	
Pulse	Triggers when the pulse width of the signal matches the trigger settings.	
Indicators	Edge/Pulse	Video
	<p>(CH1, Edge, Rising edge, DC coupling)</p>	<p>(CH1, Video, Positive polarity, NTSC standard)</p>

### Trigger parameter

Trigger source	CH1, 2	Channel 1, 2 input signals
	Line	AC mains signal
	Ext	External trigger input signal
Trigger mode	Auto	The oscilloscope updates the input signal regardless of the trigger conditions (if there is no trigger event, the oscilloscope generates an internal trigger). Select this mode especially when viewing rolling waveforms at a slow timebase.

The Auto trigger status appears in the upper right corner of the display.

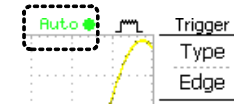

Single The oscilloscope acquires the input signals once when a trigger event occurs, then stops acquiring. Pressing the Single key again will repeat the process.



The Single trigger status appears in the upper right corner of the display.



Normal The oscilloscope acquires and updates the input signals only when a trigger event occurs.

The Normal trigger status appears in the upper right corner of the display.



Holdoff The holdoff function defines the waiting period before GDS-1000A starts triggering again after a trigger point. The Holdoff function ensures a stable display.

Video standard (video trigger)



NTSC	National Television System Committee
PAL	Phase Alternative by Line
SECAM	SEquential Couleur A Mémoire

Sync polarity (video trigger)

	Positive polarity
	Negative polarity

Video line (video trigger)

Selects the trigger point in the video signal.	field	1 or 2
--	-------	--------

	line	1~263 for NTSC, 1~313 for PAL/SECAM
Pulse condition (pulse trigger)	Sets the pulse width (20ns ~ 10s) and the triggering condition.	
	>	Longer than = Equal to
	<	Shorter than ≠ Not equal to
Trigger slope		Triggers on the rising edge.
		Triggers on the falling edge.
Trigger coupling	AC	Triggers only on AC component.
	DC	Triggers on AC+DC component.
Frequency rejection	LF	Puts a high-pass filter and rejects the frequency below 50kHz.
	HF	Puts a low-pass filter and rejects the frequency above 50kHz.
Noise rejection	Rejects noise signals.	
Trigger level		Using the trigger level knob moves the trigger point up or down.

**Configuring Holdoff**

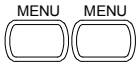
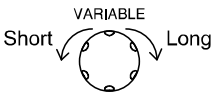
Background	The Holdoff function defines the waiting period before GDS-1000A starts triggering again after the trigger point. The holdoff function is especially useful for waveforms with two or more repetitive frequencies or periods that can be triggered.	
Panel operation	1. Press the Trigger menu key twice.	
	2. To set the Holdoff time, use the Variable knob. The resolution depends on the horizontal scale.	
	Range	40ns~2.5s

Pressing *Set to Minimum* sets the Holdoff time to the minimum, 40ns.



Note: The holdoff function is automatically disabled when the waveform update mode is in Roll mode.

**Configuring the edge trigger**

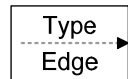
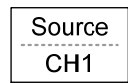
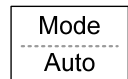
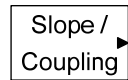
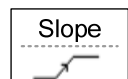
Procedure	1. Press the Trigger menu key.	
	2. Press <i>Type</i> repeatedly to select edge trigger.	
	3. Press <i>Source</i> repeatedly to select the trigger source.	
		Range Channel 1, 2, Line, Ext
	4. Press <i>Mode</i> repeatedly to select the Auto or Normal trigger mode. To select the single trigger mode, press the Single key.	
		Range Auto, Normal
5. Press <i>Slope/coupling</i> to enter into the trigger slope and coupling selection menu.		
6. Press <i>Slope</i> repeatedly to select the trigger slope, rising or falling edge.		
	Range	Rising edge, falling edge

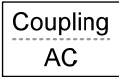
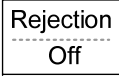
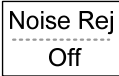
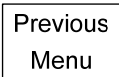

- 7. Press *Coupling* repeatedly to select the trigger coupling, DC or AC. 
  - Range DC, AC
- 8. Press *Rejection* to select the frequency rejection mode. 
  - Range LF, HF, Off
- 9. Press *Noise Rej* to turn the noise rejection on or off. 
  - Range On, Off
- 10. Press *Previous* menu to go back to the previous menu. 

**Configuring the video trigger**

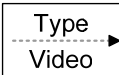
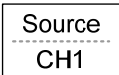
- Procedure
- 1. Press the Trigger menu key. 
  - 2. Press *Type* repeatedly to select video trigger. The video trigger indicator appears at the bottom of the display. 
  - 3. Press *Source* repeatedly to select the trigger source channel. 
    - Range Channel 1, 2

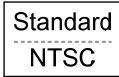
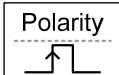
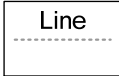
- 4. Press *Standard* repeatedly to select the video standard. 
  - Range NTSC, PAL, SECAM
- 5. Press *Polarity* repeatedly to select the video signal polarity. 
  - Range positive, negative
- 6. Press *Line* repeatedly to select the video field line. Use the Variable knob to select the video line. 
  - Field 1, 2
  - Video line NTSC: 1 ~ 262 (Even), 1 ~ 263 (Odd)  
PAL/SECAM: 1 ~ 312 (Even), 1 ~ 313 (Odd)

**Configuring the pulse width trigger**

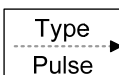
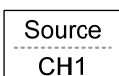
- Procedure
- 1. Press the Trigger menu key. 
  - 2. Press *Type* repeatedly to select pulse width trigger. The pulse width trigger indicator appears at the bottom of the display. 
  - 3. Press *Source* repeatedly to select the trigger source. 
    - Range Channel 1, 2, Ext

4. Press *Mode* repeatedly to select the trigger mode, Auto or Normal. To select the Single trigger mode, press the Single key.
 

Range    Auto, Normal

Mode  
-----  
Auto

SINGLE
  
5. Press *When* repeatedly to select the pulse condition. Then use the Variable knob to set the pulse width.
 

Condition    > , < , = , ≠  
Width        20ns ~ 10s

When <  
-----  
20.0ns

VARIABLE
  
6. Press *Slope/Coupling* to set trigger slope and coupling.
 

Range        Rising edge, falling edge

Slope /  
-----  
Coupling
  
7. Press *Slope* repeatedly to select the trigger slope, which also appears at the bottom of the display.
 

Range        Rising edge, falling edge

Slope  
-----
  
8. Press *Coupling* repeatedly to select the trigger coupling.
 

Range        DC, AC

Coupling  
-----  
AC
  
9. Press *Rejection* to select the frequency rejection mode.
 

Range        LF, HF, Off

Rejection  
-----  
Off

10. Press *Noise Rej* to turn the noise rejection on or off.
 

Range        On, Off

Noise Rej  
-----  
Off
  
11. Press *Previous* menu to go back to the previous menu.
 

Range        On, Off

Previous  
-----  
Menu

### Manually triggering the signal



Note: This section describes how to manually trigger the input signals when the oscilloscope does not capture them. This section applies to the Normal and Single trigger mode, since in the Auto trigger mode, the oscilloscope keeps updating the input signal regardless of the trigger conditions.

To acquire the signal regardless of trigger conditions

To acquire the input signal regardless of the trigger condition, press the Force key. The oscilloscope captures the signals once.



In the Single trigger mode





Press the Single key to start waiting for the trigger condition. To break out of the Single mode, press the Run/Stop key. The trigger mode changes to the Normal mode.

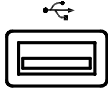

## USB Port Interface

The USB port can be set to auto detect, however occasionally the USB host type cannot be detected. The USB Port function allows the USB host type to be manually or automatically set.

USB connection	PC / Printer end	Type A, host
	GDS-1000A end	Type B, slave
	Speed	1.1/2.0 (full speed)

- Procedure
1. Connect the USB cable to the USB slave port on the GDS-1000A. 
  2. Insert the other end of the USB cable into the PC or Printer USB port. 
  3. Press the Utility key. 
  4. Press More (F5). 
  5. Press *USB Port* repeatedly to set the host device. 
- Range      Printer, PC, Auto Detect

## Remote Control Interface

The Remote control interface section describes how to set up the USB interface for PC connection. Remote control command details are described in the GDS-1000A Programming Manual. Note that printing to a PictBridge compatible printer and remote control cannot be supported at the same time as the same USB port is used.

USB connection	PC / Printer end	Type A, host
	GDS-1000A end	Type B, slave
	Speed	1.1/2.0 (full speed)



- Procedure
1. Connect the USB cable to the USB slave port. 
  2. The USB port may need to be configured if the USB port is not automatically detected. Page85
  3. When the PC asks for the USB driver, select dso\_cdc\_1000.inf (Windows XP) or dso\_vista\_cdc.inf (Vista 32bit) which are downloadable from the GW website, [www.gwinstek.com](http://www.gwinstek.com), GDS-1000A product corner.
  4. On the PC, activate a terminal application such as MTTY (Multi-Threaded TTY). To check the COM port No., see the Device Manager in the PC. For WindowsXP, select Control panel → System → Hardware tab.

5. Run this query command via the terminal application.  
\*idn?  
This command should return the manufacturer, model number, serial number, and firmware version in the following format.  
GW, GDS-1152A, XXXXXXXX, V1.00
6. Configuring the command interface is complete. Refer to the programming manual for the remote commands and other details.

## System Settings

The system settings show the oscilloscope’s system information and allow changing the language.

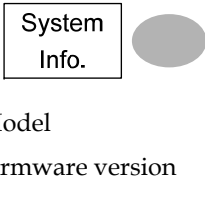
### Viewing the system information

- |           |  |   |
|-----------|--|---|
| Procedure | 1. Press the Utility key.  |  |
|           | 2. Press <i>System Info</i> . The upper half of the display shows the following information. |  |
|           | 3. Press any other key to go back to the waveform display mode.                              |  |

### Selecting the language

- |           |   |
|-----------|---|
| Parameter | Language selection differs according to the region to which the oscilloscope is shipped.  |
|           | <ul style="list-style-type: none"> <li>• English</li> <li>• Chinese (simplified)</li> <li>• Korean</li> <li>• German</li> <li>• Portuguese</li> <li>• Polish</li> <li>• Chinese (traditional)</li> <li>• Japanese</li> <li>• French</li> <li>• Russian</li> <li>• Italian</li> <li>• Spanish</li> </ul> |

Procedure

1. Press the Utility key.



2. Press *Language* repeatedly to select the language.



# SAVE/RECALL

The save function allows saving display images, waveform data, and panel settings into the oscilloscope's internal memory or an external SD card. The recall function allows recalling the default factory settings, waveform data, and panel settings from the oscilloscope's internal memory or an external SD card.

## File Structures

Three types of file are available: display image, waveform file, and panel settings.

### Display image file format

Format	xxxx.bmp (Windows bitmap format)
Contents	The current display image in 234 x 320 pixels, color mode. The background color can be inverted (Ink saver function).

### Waveform file format

Format	xxxx.csv (Comma-separated values format which can be opened in spreadsheet applications such as Microsoft Excel)
	Files can be saved as two different types of CSV formats. The GDS-1000A can recall any of the two formats

	Detail	Contains the waveform amplitude and time of each point (4k/1M/2M) relative to the trigger point.
	Fast	Only contains the waveform amplitude data for each point (4k/1M/2M).
Waveform type	CH1, 2	Input channel signal
	Math	Math operation result (page57)
Storage location	Internal memory	The oscilloscope's internal memory, which can hold 15 waveforms.
	External SD/SDHC card	An SD/SDHC card (FAT or FAT32 format) can hold practically an unlimited number of waveforms.
	Ref A, B	Two reference waveforms are used as a buffer to recall a waveform in the display. You have to save a waveform into internal memory or an SD card, then copy the waveform into the reference waveform slot (A or B), and then recall the reference waveform into the display.

Waveform data format

One division includes 25 points of horizontal and vertical data. The vertical point starts from the center line. The horizontal point starts from the leftmost waveform.

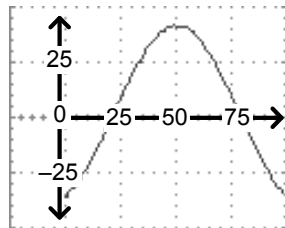

The time or amplitude represented by each data point depends on the vertical and horizontal scale. For example:  
 Vertical scale: 100mV/div (4mV per point)  
 Horizontal scale: 100us/div (4us per point)

Waveform Memory Depth

The memory depth is limited to 1 M points when both channels are activated or 2M points when only a single channel is activated. The signal must be triggered /stopped to have access to the full memory depth. Therefore when a signal is saved the waveform will be automatically stopped if it is not manually triggered /stopped first.

There are a number of conditions when all of the available memory is not utilized due to a limited number of different sample rates. This can be caused by an un-triggered signal, or a time/div setting that is too fast to display all the points on screen.



Note: 2M point memory lengths are only available for time bases slower than 10ns/div on a single channel, and 1 M point memory lengths are only available for time bases slower than 25ns/div on two channels.

Waveform file contents: other data

A waveform file also includes the following information.

- Memory Length
- Source
- Vertical Units
- Vertical Position
- Horizontal Scale
- Horizontal Mode
- Firmware
- Mode
- Trigger Level
- Probe
- Vertical Scale
- Horizontal Units
- Horizontal Position
- Sampling Period
- Time
- Waveform Data

**Setup file format**

Format	xxxx.set (proprietary format) A setup file saves or recalls the following settings.	
Contents	Acquire	<ul style="list-style-type: none"> <li>mode</li> </ul>
	Cursor	<ul style="list-style-type: none"> <li>source channel</li> <li>cursor on/off</li> <li>cursor location</li> </ul>
	Display	<ul style="list-style-type: none"> <li>dots/vectors</li> <li>grid type</li> <li>accumulation on/off</li> </ul>
	Measure	<ul style="list-style-type: none"> <li>item</li> </ul>
	Utility	<ul style="list-style-type: none"> <li>hardcopy type</li> <li>language</li> <li>ink saver on/off</li> </ul>
	Horizontal	<ul style="list-style-type: none"> <li>display mode</li> <li>position</li> <li>scale</li> </ul>
	Trigger	<ul style="list-style-type: none"> <li>trigger type</li> <li>trigger mode</li> <li>video polarity</li> <li>pulse timing</li> <li>source channel</li> <li>video standard</li> <li>video line</li> <li>slope/coupling</li> </ul>
	Channel (vertical)	<ul style="list-style-type: none"> <li>vertical scale</li> <li>coupling mode</li> <li>bandwidth limit on/off</li> <li>vertical position</li> <li>invert on/off</li> <li>probe</li> </ul>
	Math	<ul style="list-style-type: none"> <li>operation type</li> <li>vertical position</li> <li>FFT window</li> <li>source channel</li> <li>unit/div</li> </ul>

**Using the SD card file utilities**

Background	When an SD card is inserted into the oscilloscope, file utilities (file deletion, folder creation and file/folder renaming) are available from the front panel.	
SD Card restriction	The GDS-1000A series accepts the following SD cards: Type: SD, SDHC Class: 2,4,6 Size: Up to 32GB (SDHC) Format: FAT or FAT32	
Procedure	<ol style="list-style-type: none"> <li>1. Insert an SD card into the card slot.</li> <li>2. Press the Save/Recall key. Select any save or recall function. For example SD card destination in the Save image function.</li> <li>3. Press <i>File Utilities</i>. The display shows the SD card contents.</li> <li>4. Use the Variable knob to move the cursor. Press <i>Select</i> to go into the folder or go back to the previous directory level.</li> </ol>	

SD card indicator When an SD card is inserted into the oscilloscope, an indicator appears at the right bottom corner of the display. (The SD card shouldn't be removed when a file is saved or retrieved from the SD card).

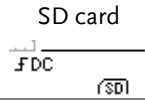

Creating a new folder / renaming a file or folder

1. Move the cursor to the file or folder location and press *New Folder* or *Rename*. The file/folder name and the character map will appear on the display.

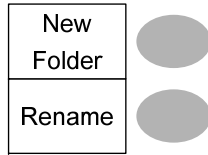

2. Use the Variable knob to move the pointer to the characters. Press *Enter* Character to add a character or *Back Space* to delete a character.

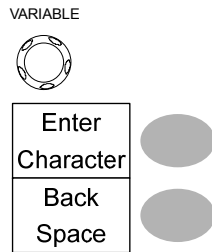

3. When editing is complete, press *Save*. The new/renamed file or folder will be saved.

Deleting a folder or file

1. Move the cursor to the folder or file location and press *Delete*. The message "*Press F4 again to confirm this process*" appears at the bottom of the display.



2. If the file/folder still needs to be deleted, press *Delete* again to complete the deletion. To cancel the deletion, press any other key.





## Quick Save (HardCopy)

Background	<p>The Hardcopy key works as a shortcut for printing screen images directly to a printer or to save display images, waveform data, and panel settings onto an SD card.</p> <p>The Hardcopy key can be configured into three types of operations: save image, save all (image, waveform, setup) and printer.</p> <p>Using the Save/Recall key can also save files with more options. For details, see page99.</p>	
Functionalities	Save image (*.bmp)	Saves the current display image into an SD card.
	Save all	<p>Saves the following items into an SD card.</p> <ul style="list-style-type: none"> <li>• Current display image (*.bmp)</li> <li>• Current system settings (*.set)</li> <li>• Current waveform data (*.csv)</li> </ul>
SD Card restriction	<p>The GDS-1000A series accepts the following SD cards:</p> <p>Type: SD, SDHC</p> <p>Class: 2,4,6</p> <p>Size: Up to 32GB (SDHC)</p> <p>Format: FAT or FAT32</p>	

Procedure	<ol style="list-style-type: none"> <li>1. Insert an SD card to the slot.</li> <li>2. Press the Utility key.</li> <li>3. Press <i>Hardcopy Menu</i>.</li> </ol>
-----------	--

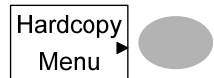
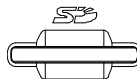

4. Press *Function* repeatedly to select *Save Image* or *Save All*.
  5. To invert the color in the display image, press *Ink Saver*. This turns Ink Saver on or off.
  6. Press *Mem Leng* repeatedly to select *SD Normal* or *SD 1M/2M*. SD Normal and SD 1M/2M sets the waveforms to a 4k and 1M/2M memory length when saving, respectively.
- 1M memory length is available when both CH1 and CH2 are active; 2M memory length is available when a single channel is active only.
7. Press the Hardcopy key. The file or folder will be saved to the root directory of the SD card.

## Save







This section describes how to save data using the Save/Recall menu.

### File type/source/destination

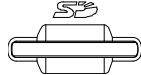
Item	Source	Destination
Panel setup (xxx.set)	<ul style="list-style-type: none"> <li>Panel settings</li> </ul>	<ul style="list-style-type: none"> <li>Internal memory: S1 ~ S15</li> <li>External memory: SD card</li> </ul>
Waveform data (xxx.csv)	<ul style="list-style-type: none"> <li>Channel 1, 2</li> <li>Math operation result</li> <li>Reference waveform A, B</li> </ul>	<ul style="list-style-type: none"> <li>Internal memory: W1 ~ W15</li> <li>Reference waveform A, B</li> <li>External memory: SD card</li> </ul>
Display image (xxx.bmp)	<ul style="list-style-type: none"> <li>Display image</li> </ul>	<ul style="list-style-type: none"> <li>External memory: SD card</li> </ul>
Save All	<ul style="list-style-type: none"> <li>Display image (xxx.bmp)</li> <li>Waveform data (xxx.csv)</li> <li>Panel settings (xxx.set)</li> </ul>	<ul style="list-style-type: none"> <li>External memory: SD card</li> </ul>

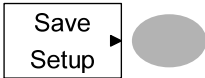
SD Card restriction  
 The GDS-1000A series accepts the following SD cards:  
 Type: SD, SDHC  
 Class: 2,4,6  
 Size: Up to 32GB (SDHC)  
 Format: FAT or FAT32

## Saving the panel settings



- Procedure
- (For saving to an external SD card) Insert the card into the slot. 
  - Press the Save/Recall key twice to access the Save menu. 
  - Press *Save Setup*. 
  - Press *Destination* repeatedly to select the saved location. Use the Variable knob to change the internal memory location (S1 ~ S15).  
- |         |   |
|---------|---|
| Memory  | Internal memory, S1 ~ S15   |
| SD card | External card, no practical limitation for the amount of file. When saved, the setup file will be placed in the root directory. |
- Press *Save* to confirm saving. When completed, a message appears at the bottom of the display. 

Note  The file will not be saved if the power is turned off or the SD card is disconnected before completion.



File utilities To edit SD card contents (create/ delete/ rename files and folders), press *File Utilities*. For details, see page94.

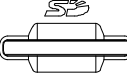
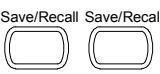

**Saving the waveform**

- Procedure
- (For saving to an external SD card) Insert the card into the slot.
 
  - Press the Save/Recall key twice to access the Save menu.
 
  - Press *Save Waveform*.
 
  - Press *Source*. Use the Variable knob to select the source signal.
 

VARIABLE



    - CH1 ~ CH2 Channel 1 ~ 2 signal
    - Math Math operation result (page57)
    - RefA, B Internally stored reference waveforms A, B
  - Press *Destination* repeatedly to select the file destination. Use the Variable knob to select the memory location.
 

VARIABLE



    - Memory Internal memory, W1 ~ W15

- SD Normal Save to the SD card with a 4k waveform memory length.
- SD 1M Save to the SD card with a 1M waveform memory length. For 2 channel operation only.
- SD 2M Save to the SD card with a 2M waveform memory length. For single channel operation only.
- Ref Internal reference waveform, A/B

- Press *Save* to confirm saving. When completed, a message appears at the bottom of the display.
 

Note  The file will not be saved if the power is turned off or the SD card is disconnected before completion.

File utilities To edit SD card contents (create/ delete/ rename files and folders), press *File Utilities*. For details, see page94.



**Saving the display image**

Background Saving the display image can be used as a screen capture or it can be used as a reference waveform.

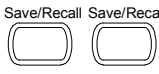
- Procedure
- (For saving to an external SD card) Insert the card into the slot.
 
  - Press the Save/Recall key twice to access the Save menu.
 

3. Press *Save Image*.



4. Press *Ink Saver* repeatedly to invert the background color (on) or not (off).



5. Press *Destination*.

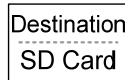

SD card External card, no practical limitation on the amount of files. When saved, the image file will be placed in the root directory.

6. Press *Save* to confirm saving. When completed, a message appears at the bottom of the display.



Note  The file will not be saved if the power is turned off or the SD card is disconnected before completion.

**File utilities**

To edit SD card contents (create/ delete/ rename files and folders), press *File Utilities*. For details, see page94.



**Saving all (panel settings, display image, waveform)**

**Procedure**

1. (For saving to an external SD card) Insert the card into the slot.

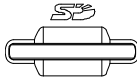

2. Press the *Save/Recall* key twice to access the Save menu.



3. Press *Save All*. The following information will be saved.



Setup file (Axxx.set) Two types of setups are saved: the current panel setting and the last internally saved settings (one of S1 ~ S15).

Display image (Axxx.bmp) The current display image in the bitmap format.

Waveform data (Axxx.csv) Two types of waveform data are saved: the currently active channel data and the last internally saved data (one of W1 ~ W15).

4. Press *Ink Saver* repeatedly to invert the background color (on) or not (off) for the display image.

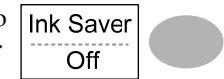

5. Press *Destination*.



SD Normal Save to the SD card with a 4k waveform memory length.

SD 1M Save to the SD card with a 1M waveform memory length. For 2 channel operation only.

SD 2M Save to the SD card with a 2M waveform memory length. For single channel operation only.

6. Press *Save* to confirm saving. When completed, a message appears at the bottom of the display.



Note  The file will not be saved if the power is turned off or the SD card is disconnected before completion.

7. Together with the current setup/waveform/image, the last saved waveform file (one from W1 ~ W15) and setup file (one from S1 ~ S15) are also included in the folder.

**File utilities**

To edit SD card contents (create/ delete/ rename files and folders), press *File Utilities*. For details, see page94.



## Recall

### File type/source/destination



Item	Source	Destination
Default panel setup	<ul style="list-style-type: none"> <li>Factory installed setting</li> </ul>	<ul style="list-style-type: none"> <li>Current front panel</li> </ul>
Reference waveform	<ul style="list-style-type: none"> <li>Internal memory: A, B</li> </ul>	<ul style="list-style-type: none"> <li>Current front panel</li> </ul>
Panel setup (DSxxx.set)	<ul style="list-style-type: none"> <li>Internal memory: S1 ~ S15</li> <li>External memory: SD card</li> </ul>	<ul style="list-style-type: none"> <li>Current front panel</li> </ul>
Waveform data (DSxxx.csv)	<ul style="list-style-type: none"> <li>Internal memory: W1 ~ W15</li> <li>External memory: SD card</li> </ul>	<ul style="list-style-type: none"> <li>Reference waveform A, B</li> </ul>

SD Card restriction  
 The GDS-1000A series accepts the following SD cards:  
 Type: SD, SDHC  
 Class: 2,4,6  
 Size: Up to 32GB (SDHC)  
 Format: FAT or FAT32

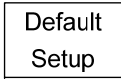

**Recalling the default panel settings**

- Procedure
1. Press the Save/Recall key. 
  2. Press *Default Setup*. The factory installed setting will be recalled. 



Setting contents The following is the default panel setting contents.

Acquisition	Mode: Normal	
Channel	Coupling: DC	Invert: Off
	BW limit: Off	voltage: x1
Cursor	Source: CH1	Horizontal: None
	Vertical: None	
Display	Type: Vectors	Accumulate: Off
	Graticule: 	
Horizontal	Scale: 2.5us/Div	Mode: Main Timebase
Math	Type: + (Add)	Channel: CH1+CH2
	Position: 0.00 Div	Unit/Div: 2V
Measure	Item: Vpp, Vavg, Frequency, Duty cycle, Rise Time	
Trigger	Type: Edge	Source: Channel1
	Mode: Auto	Slope: 
	Coupling: DC	Rejection: Off
	Noise Rejection: Off	
Utility	SaveImage, InkSaver Off	

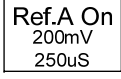
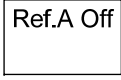
**Recalling a reference waveform to the display**

- Procedure
1. The reference waveform must be stored in advance. See page 101 for details.
  2. Press the Save/Recall key. 
  3. Press *Display Refs*. The reference waveform display menu appears. 
  4. Select the reference waveform, *Ref A* or *Ref B*, and press it. The waveform appears on the display and the period and amplitude of the waveform appears in the menu.    
 ↓   
 
  5. To clear the waveform from the display, press *RefA/B* again. 

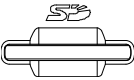
**Recalling panel settings**

- Procedure
1. (For recalling from an external SD card) Insert the card into the slot. 
  2. Press the Save/Recall key. 

3. Press *Recall Setup*.



4. Press *Source* repeatedly to select the file source, internal or external memory. Use the Variable knob to change the memory.

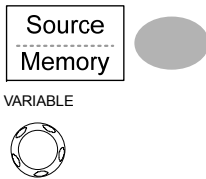

Memory Internal memory, S1 ~ S15  
 SD card External card, no practical limitation on the amount of file. The setup file must be placed in the root directory to be recognized.

5. Press *Recall* to confirm recalling. When completed, a message appears at the bottom of the display.



Note The file will not be recalled if the power is turned Off or the SD card is disconnected before completion.

File utilities To edit SD card contents (create/ delete/ rename files and folders), press *File Utilities*. For details, see page94.



Recalling a waveform

Procedure 1. (For recalling from an external SD card) Insert the card into the slot.

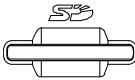

2. Press the Save/Recall key.



3. Press *Recall Waveform*. The display shows the available source and destination options.

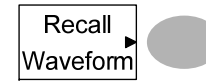

4. Press *Source* repeatedly to select the file source, internal memory or external SD card. Use the Variable knob to change the memory location (W1 ~ W15).

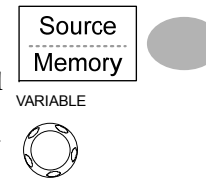

Memory Internal memory, W1 ~ W15  
 SD card External flash drive, no practical limitation on the amount of files. The waveform file must be placed in the root directory to be recognized.

5. Press *Destination*. Use the Variable knob to select the memory location.

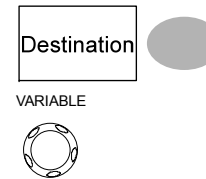

RefA, B Internally stored reference waveforms A, B

6. Press *Recall* to confirm recalling. When completed, a message appears at the bottom of the display.

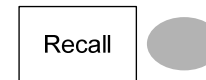

Note The file will not be recalled if the power is turned off or the SD card is disconnected before completion.

**File utilities**

To edit the SD card contents (create/ delete/ rename files and folders), press *File Utilities*. For details, see page94.



**Recall Image**

**Background**

Recall Image is useful for recalling reference images that would not be possible using the Recall Waveform function, such as in X-Y mode. Using the Recall Image function will superimpose the reference image on the screen.

Before recalling an image, an image must first be saved to an SD card, see page102.

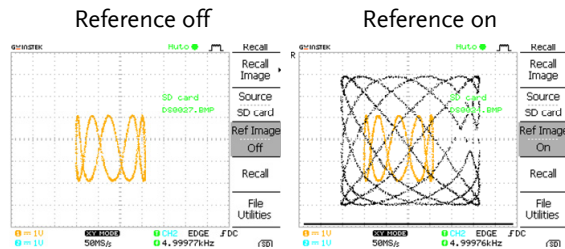

**Procedure**

1. Insert an SD card into the slot to recall from SD memory.
2. Press the Save/Recall key.
3. Press *Recall Image*. The display shows the available source and destination options.

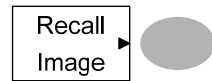
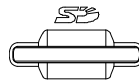

4. Use the Variable knob to choose a file name (DSXXXX.BMP).



SD card The image file must be placed in the root directory to be recognized.

5. Press *Recall* to confirm recalling. When completed, a message appears at the bottom of the display.



6. Press *Reference Image* to turn on /off the current image.



**Note** ⚠ The file will not be recalled if the power is turned off or the SD card is disconnected before completion.

**File utilities**

To edit the SD card contents (create/ delete/ rename files and folders), press *File Utilities*. For details, see page94.





# PRINT

The GDS-1000A is able to print screen images directly to a PictBridge compatible printer. The printed images can use the "Ink Saver" feature to print onto a white rather than a black background to reduce the amount of ink used. Note that printing and remote control cannot be used at the same time.

## Print (Hardcopy)

### Background



The Hardcopy key works as a shortcut for printing screen images directly to a printer or to save display images, waveform data, and panel settings onto an SD card.

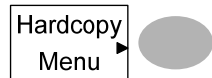

The Hardcopy key can be configured into three types of operations: save image, save all (image, waveform, setup) and printer.

### Procedure

1. Ensure the USB Port has been configured properly and that the USB cable is connected. Page 85.
2. Press the Utility key. 
3. Press *Hardcopy Menu*. 

4. Press *Function* repeatedly to select *Printer*. 
5. To invert the color in the display image, press *Ink Saver*. This turns Ink Saver on or off. 
6. To change the default page size, press *Page Size*. 

Default	Default printer page setting.
4 X 6	4 X 6 inches
A4	Standard A4 size

7. Press the Hardcopy key.  The current screen image will be printed to the printer.

The Hardcopy key can be used to print to a printer each time until it is configured otherwise.



Note: If the error message "Printer Not Ready" is displayed, please check to ensure the printer is turned on, the USB cable is properly connected, and that the printer is ready.

The USB port may need to be manually set to Printer, see page85.

# MAINTENANCE

Two types of maintenance operations are available: calibrating the vertical resolution, and compensating the probe. Run these operations when using the oscilloscope in a new environment.

## Vertical Resolution Calibration

Procedure

1. Press the Utility key.



2. Press *More*.

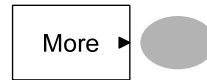

3. Press *Self Cal Menu*.

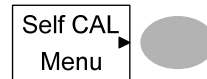

4. Press *Vertical*. The message "Set CAL to CH1, then press F5" appears at the bottom of the display.



5. Connect the calibration signal between the rear panel CAL out terminal and the Channel1 input.

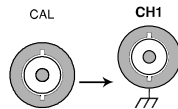

6. Press F5. The calibration automatically starts.

7. The Channel1 calibration will complete in less than 5 minutes.

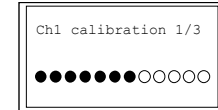

8. When finished, connect the calibration signal to the Channel 2 input and repeat the procedure.



9. When the calibration is complete the display will go back to the previous state.

## Probe Compensation

Procedure

1. Connect the probe between the Channel1 input and the probe compensation output (2Vp-p, 1kHz square wave) on the front panel. Set the probe attenuation to x10.

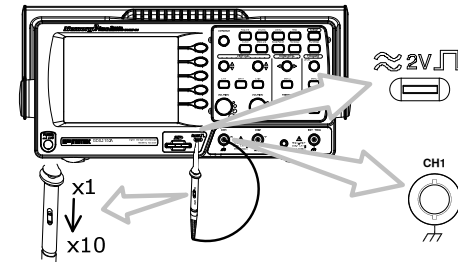

2. Press the Utility key.



3. Press *ProbeComp*.

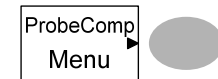

4. Press *Wavetype* repeatedly to select the standard square wave.

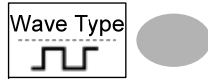

5. Press the *Autoset* key. The compensation signal will appear in the display.



6. Press the *Display* key, then *Type* to select the vector waveform.

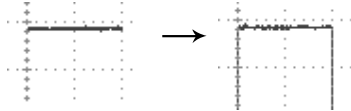
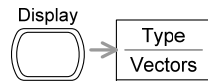

7. Turn the adjustment point on the probe until the signal edge becomes sharp.

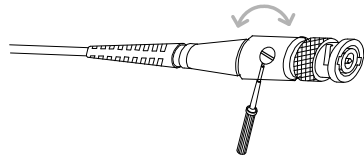
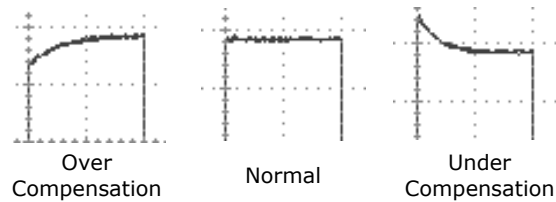

# FAQ

- The input signal does not appear in the display.
- I want to remove some contents from the display.
- The waveform does not update (frozen).
- The probe waveform is distorted.
- Autoset does not catch the signal well.
- I want to clean up the cluttered panel settings.
- The accuracy does not match the specifications.
- The SD card slot does not accept my card.
- The oscilloscope will not allow a 2M waveform to be saved.

## The input signal does not appear in the display.

Make sure you have activated the channel by pressing the CH key (page42).

## I want to remove some contents from the display.

To clear the math result, press the Math key again (page57).

To clear the cursor, press the Cursor key again (page54).

To clear the Help contents, press the Help key again (page41).

---

### The waveform does not update (frozen).

Press the Run/Stop key to unfreeze the waveform. See page44 for details. For trigger setting details, see page77.

If this does not help, press the CH key. If the signal still does not appear, press the Autoset key.

---

### The probe waveform is distorted.

You might need to compensate the probe. For details, see page116. Note that the frequency accuracy and duty factor are not specified for probe compensation waveforms and therefore it should not be used for other reference purposes.

---

### Autoset does not catch the signal well.

The Autoset function does not catch signals well under 30mV or 20Hz. Please operate the oscilloscope manually. See page43 for details.

---

### I want to clean up the cluttered panel settings.

Recall the default settings by pressing the Save/Recall key→Default Setting. For default setting contents, see page40.

---

### The saved display image is too dark on the background.

Use the Inksaver function which reverses the background color. For details, see page102.

---

### The accuracy does not match the specifications.

Make sure the device is powered on for at least 30 minutes, within +20°C~+30°C. This is necessary to stabilize the unit to match the specification.

---

### The SD card slot does not accept my card.

Make sure the SD card is formatted as FAT or FAT32. Try a different SD card brand if you are still having trouble.

---

### The oscilloscope will not allow a 2M waveform to be saved.

Make sure that only 1 channel is active. Make sure that the signal has been triggered and that the STOP or Single key has been pressed. Ensure the time base is slower than 10 ns/div. See page 90.

For more information, contact your local dealer or GWInstek at [www.gwinstek.com](http://www.gwinstek.com) / [marketing@goodwill.com.tw](mailto:marketing@goodwill.com.tw).

# APPENDIX

## Fuse Replacement

- Procedure
1. Remove the power cord and remove the fuse socket using a minus driver.

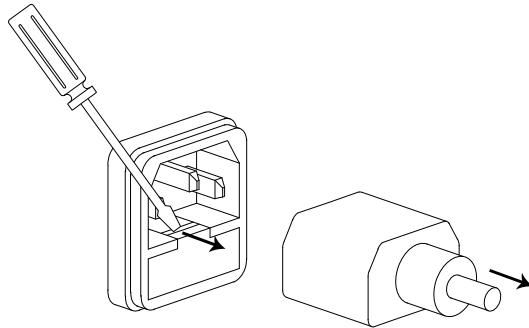

2. Replace the fuse in the holder.

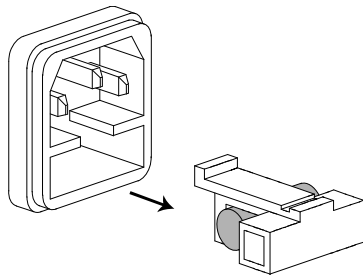

Ratings T1A, 250V

## GDS-1000A Series Specifications

The specifications apply when the oscilloscope is powered on for at least 30 minutes under +20°C~+30°C.

### Model-specific specifications

GDS-1062A	Bandwidth (-3dB)	DC coupling: DC ~ 60MHz AC coupling: 10Hz ~ 60MHz
	Bandwidth Limit	20MHz (-3dB)
	Trigger Sensitivity	0.5div or 5mV (DC ~ 25MHz) 1.5div or 15mV (25MHz~60MHz)
	External Trigger	~ 50mV (DC~25MHz)
	Sensitivity	~ 100mV (25MHz~60MHz)
	Rise Time	< 5.8ns approx.
GDS-1102A	Bandwidth (-3dB)	DC coupling: DC ~ 100MHz AC coupling: 10Hz ~ 100MHz
	Bandwidth Limit	20MHz (-3dB)
	Trigger Sensitivity	0.5div or 5mV (DC ~ 25MHz) 1.5div or 15mV (25MHz~100MHz)
	External Trigger	~ 50mV (DC~25MHz)
	Sensitivity	~ 100mV (25MHz~100MHz)
	Rise Time	< 3.5ns approx.
GDS-1152A	Bandwidth (-3dB)	DC coupling: DC ~ 150MHz AC coupling: 10Hz ~ 150MHz
	Bandwidth Limit	20MHz (-3dB)
	Trigger Sensitivity	0.5div or 5mV (DC ~ 25MHz) 1.5div or 15mV (25MHz~150MHz)
	External Trigger	~ 50mV (DC~25MHz)
	Sensitivity	~ 100mV (25MHz~100MHz)
	Rise Time	< 2.3ns approx.

**Common specifications**

Vertical	Sensitivity	2mV/div~10V/Div (1-2-5 increments)
	Accuracy	± (3% x  Readout +0.1div + 1mV)
	Bandwidth	See model-specific specifications
	Rise Time	See model-specific specifications
	Input Coupling	AC, DC, Ground
	Input Impedance	1MΩ±2%, ~15pF
	Polarity	Normal, Invert
	Maximum Input	300V (DC+AC peak), CAT II
	Math Operation	+, -, ×, FFT, FFT rms
	Offset Range	2mV/div~50mV/div: ±0.4V 100mV/div~500mV/div: ±4V 1V/div~5V/div: ±40V 10V/div : ±300V
Trigger	Sources	CH1, CH2, Line, EXT
	Modes	Auto, Normal, Single, TV, Edge, Pulse
	Coupling	AC, DC, LF rej, HF rej, Noise rej
	Sensitivity	See model-specific specifications
	Holdoff	40ns ~ 2.5s
External trigger	Range	DC: ±15V, AC: ±2V
	Sensitivity	See model-specific specifications
	Input Impedance	1MΩ±2%, ~15pF
Horizontal	Maximum Input	300V (DC+AC peak), CATII
	Range	1ns/div~50s/div, 1-2.5-5 increment Roll: 250ms/div – 50s/div
	Modes	Main, Window, Window Zoom, Roll, X-Y
	Accuracy	±0.01%
	Pre-Trigger	10 div maximum
X-Y Mode	Post-Trigger	1000 div
	X-Axis Input	Channel 1
	Y-Axis Input	Channel 2
Signal Acquisition	Phase Shift	±3° at 100kHz
	Real-Time	1G Sa/s maximum
	Equivalent	25G Sa/s maximum
	Vertical Resolution	8 bits
	Record Length	Maximum; 2M points (1 channel), 1M points (2 channels)
	Acquisition	Normal, Peak Detect, Average
	Peak Detection	10ns (500ns/div ~ 50s/div)
Average	2, 4, 8, 16, 32, 64, 128, 256	

Cursors and Measurement	Voltage	Vpp, Vamp, Vavg, Vrms, Vhi, Vlo, Vmax, Vmin, Rise Preshoot/ Overshoot, Fall Preshoot/ Overshoot
	Time	Freq, Period, Rise Time, Fall Time, + Width, – Width, Duty Cycle
	Delay	FRR, FRF, FFR, FFF, LRR, LRF, LFR, LFF
	Cursors	Voltage difference (ΔV) and Time difference (ΔT) between cursors
	Auto Counter	Resolution: 6 digits, Accuracy: ±2% Signal source: All available trigger source except the Video trigger
Control Panel Function	Autoset	Automatically adjust Vertical Volt/div, Horizontal Time/div, and Trigger level
	Save/Recall	Up to 15 sets of measurement conditions and waveforms
Display	LCD	5.6 inch, TFT, brightness adjustable
	Resolution (dots)	234 (Vertical) x 320 (Horizontal)
	Graticule	8 x 10 divisions
	Display Contrast	Adjustable
Interface	USB Slave Connector	USB1.1 & 2.0 full speed compatible (flash disk not supported)
	SD Card Slot	Image (BMP) and waveform data (CSV)
	Probe Compensation	Frequency range 1kHz ~ 100kHz adjustable, 1kHz step
Signal	Duty cycle	5% ~ 95% adjustable, 5% step
	Amplitude	2Vpp±3%
Power Source	Line Voltage	100V~240V AC, 47Hz~63Hz
	Power Consumption	18W, 40VA maximum
	Fuse Rating	1A slow, 250V
Operation Environment	Ambient temperature	0 ~ 50°C
Storage Environment	Relative humidity	≤ 80% @35°C
Dimensions	Ambient temperature	–10°C to 60°C
Weight	Relative humidity	≤ 80% @60°C
	Dimensions	310(W) x 142(H) x 140(D) mm
	Weight	Approx. 2.5kg

## Probe Specifications

### GDS-1062A/1102A/1152A Probe

Applicable model & probe	GDS-1062A GTP-060A-4*	GDS-1102A GTP-100A-4*
Position x 10	Attenuation Ratio	10:1
	Bandwidth	DC ~ 60MHz      DC ~ 100MHz
	Input Resistance	10MΩ when used with 1MΩ input
	Input Capacitance	23pF approx.      17pF approx.
	Maximum Input Voltage	500V CAT I, 300V CAT II (DC+Peak AC) Derating with frequency
	Position x 1	Attenuation Ratio
Bandwidth		DC ~ 6MHz
Input Resistance		1MΩ when used with 1MΩ input
Input Capacitance		128pF approx.      47pF approx.
Maximum Input Voltage		300V CAT I, 150V CAT II (DC+Peak AC) Derating with frequency
Operating Cond.		Temperature
	Relative Humidity	≤85% @35°C
Safety Standard	EN 61010-031 CAT II	

Applicable model & probe	GDS-1152A GTP-150A-2*	
Position x 10	Attenuation Ratio	10:1
	Bandwidth	DC ~ 150MHz
	Input Resistance	10MΩ when used with 1MΩ input
	Input Capacitance	17pF approx.
	Maximum Input Voltage	500V CAT I, 300V CAT II (DC+Peak AC) Derating with frequency
	Position x 1	Attenuation Ratio
Bandwidth		DC ~ 6MHz
Input Resistance		1MΩ when used with 1MΩ input
Input Capacitance		47pF approx.
Maximum Input Voltage		300V CAT I, 150V CAT II (DC+Peak AC) Derating with frequency
Operating Cond.		Temperature
	Relative Humidity	≤85% @35°C
Safety Standard	EN 61010-031 CAT II	

\* Note: GW Instek reserves the right to change the probe model type (GTP-060A-4, GTP-100A-4, GTP-150A-2) at anytime without notice for probe model types of similar specification.

## EC Declaration of Conformity

We

**GOOD WILL INSTRUMENT CO., LTD.**

No.7-1, Jhongsing Rd., Tucheng City, Taipei County 236, Taiwan

**GOOD WILL INSTRUMENT (SUZHOU) CO., LTD.**

No. 69, Lushan Road, Suzhou New District Jiangsu, China

declares that the below mentioned product

**GDS-1062A, GDS-1102A, GDS-1152A**

Are herewith confirmed to comply with the requirements set out in the Council Directive on the Approximation of the Law of Member States relating to Electromagnetic Compatibility (2004/108/EC) and Low Voltage Equipment Directive (2006/95/EC). For the evaluation regarding the Electromagnetic Compatibility and Low Voltage Equipment Directive, the following standards were applied:

### © EMC

EN 61326-1 :	Electrical equipment for measurement, control and laboratory use — EMC requirements (2006)	
EN 61326-2-1:	Conducted and Radiated Emissions CISPR11: 2003+A1: 2004+A2: 2006	Electrostatic Discharge IEC 61000-4-2: 2001
	Current Harmonic EN 61000-3-2: 2006	Radiated Immunity IEC 61000-4-3: 2006+A1: 2007
	Voltage Fluctuation EN 61000-3-3: 1995+A1: 2001+A2 : 2005	Electrical Fast Transients IEC 61000-4-4: 2004+Corr.1 : 2006+Corr.2 : 2007
	-----	Surge Immunity IEC 61000-4-5: 2005
	-----	Conducted Susceptibility IEN 61000-4-6: 2003+A1: 2004+A2: 2006
	-----	Power Frequency Magnetic Field IEC 61000-4-8: 2001
	-----	Voltage Dips/ Interrupts IEC 61000-4-11: 2004

### © Safety

Low Voltage Equipment Directive 2006/95/EC
Safety Requirements IEC/EN 61010-1: 2001

# INDEX

2M memory length limits .....	92	menu tree .....	24
AC coupling .....	73	shortcut .....	24
Accumulating waveform .....	66	specification .....	124
Acquisition .....	61	Cycle time measure .....	50
menu tree .....	23	DC coupling .....	72
short cut .....	23	Declaration of conformity .....	126
specification .....	123	Default setup .....	107
Addition .....	58	contents .....	40
Amplitude measure .....	49	menu tree .....	29
Auto set .....	43	Delay measure .....	50
exception .....	44	Delay mode .....	63
specification .....	124	Delay Off .....	64
Auto trigger .....	77	Delay On .....	63
Automatic measurement .....	51	Display .....	67
menu tree .....	28	contrast setting .....	67
overview .....	49	diagram .....	18
shortcut .....	28	grid setting .....	67
specification .....	124	menu tree .....	25
Average acquisition .....	62	shortcut .....	25
Average voltage measure .....	50	specification .....	124
Bandwidth limitation .....	75	Display image .....	
Blackman window .....	58	faq .....	119
Calibration .....		file format .....	90
menu tree .....	37	recall menu tree .....	30
Calibration, vertical resolution .....	115	save .....	102
Caution symbol .....	7	save menu tree .....	32
Channel .....	42	Dot waveform .....	66
faq .....	118	Duty cycle measure .....	50
menu tree .....	23	Edge trigger .....	80
shortcut .....	23	menu tree .....	35
Cleaning the instrument .....	9	EN 61010-031 .....	125
Configure remote control .....	87	EN61010 .....	
Coupling mode .....	72	measurement category .....	8
menu tree .....	23	pollution degree .....	9
Cursor .....	54	Environment .....	124
faq .....	118	safety instructions .....	9
		Equivalent time sampling .....	65
		Expand Center .....	73

Expand Ground .....	73	in display save .....	103
External trigger .....	77	in hardcopy .....	98
input terminal .....	16	in print .....	114
Falling time measure .....	50	in save all .....	104
Faq .....	119	Input frequency indicator .....	18
FFT .....	59	Invert waveform .....	74
menu tree .....	27	Language selection .....	88
overview .....	57	List of features .....	11
File format .....	90	Low voltage measure .....	50
Firmware version .....	88	Math .....	
Flattop window .....	57	faq .....	118
Force trigger .....	84	menu tree .....	26
Frequency measure .....	50	overview .....	57
Frequency rejection .....	79	shortcut .....	26
Front panel diagram .....	13	Measurement .....	42
Fuse replacement .....	121	Memory Length .....	
safety instruction .....	9	faq .....	120
General purpose signal .....	47	Model comparison .....	11
Ground .....		Multiplication .....	58
coupling .....	72	Negative peak measure .....	49
symbol .....	7	Noise rejection .....	79
terminal .....	15	Normal acquisition .....	61
Hanning window .....	57	Normal trigger .....	78
Hardcopy .....	97	NTSC .....	78
shortcut .....	38	Operating environment .....	124
Hardcopy - Printer .....		Overshoot voltage measure .....	50
menu tree .....	38	Page size .....	
Hardcopy - Save All .....		in print .....	114
menu tree .....	38	PAL .....	78
Hardcopy - Save image .....		Peak detect acquisition .....	62
menu tree .....	39	Peak to peak measure .....	49
Help .....	41	Peak voltage measure .....	49
faq .....	118	Power on/off .....	
High voltage measure .....	49	safety instruction .....	8
holdoff .....	79	switch overview .....	17
Horizontal .....	68	Preshoot voltage measure .....	50
basic operation .....	45	Print .....	113
cursor operation .....	54	Probe .....	116
menu tree .....	26	attenuation level .....	75
position .....	68	attenuation menu tree .....	23
scale .....	68	compensation menu tree .....	39
shortcut .....	26	compensation signal overview .....	47
specification .....	123	faq .....	119
Image .....		peak detect demonstration .....	62
recall .....	111	Pulse time measure .....	50
Ink saver .....		Pulse width trigger .....	82



condition.....	79	recall .....	108
menu tree.....	35	recall menu tree .....	29
Real time sampling.....	65	save menu tree.....	31
Rear panel diagram .....	17	Single trigger.....	84
Recall.....	106	Single trigger mode.....	78
default setup.....	107	Specifications.....	122
image .....	111	faq .....	120
menu tree.....	29	Subtraction .....	58
reference waveform .....	108	System information.....	88
setup .....	108	Timebase indicator.....	68
shortcut .....	29	Trigger.....	77
waveform.....	109	coupling .....	79
Rectangular window .....	57	edge.....	80
Reference waveform		force .....	84
menu tree.....	31	indicator.....	77
recall .....	108	level knob.....	79
Remote control interface .....	85, 86	menu tree.....	34
Rising time measure.....	50	parameter.....	77
Roll mode .....	69	pulse width.....	82
Root mean square measure .....	50	shortcut .....	34
Run/stop .....	44	specification.....	123
faq .....	119	status indicator .....	18
Save .....	99	video .....	81
display image.....	102	UK power cord .....	10
menu tree.....	29	Utility	
setup .....	100	key overview .....	14
shortcut .....	29	menu tree.....	37
specification.....	124	shortcut .....	37
waveform.....	101	Vector waveform.....	66
Save all.....	103	Vertical .....	72
menu tree.....	33	basic operation.....	46
SD card		cursor operation.....	55
faq .....	120	position.....	72
file menu tree .....	33	resolution calibration.....	115
file operation .....	94, 97, 99, 106	scale .....	72
SECAM .....	78	specification.....	123
Security lock slot .....	17	Video line.....	78
Serial number.....	88	Video trigger .....	81
Service operation		menu tree.....	34
about disassembly.....	8	Warning symbol.....	7
contact .....	120	Waveform	
Setting the handle .....	19	expand waveform .....	73
Setting up the oscilloscope .....	19	file format .....	90
Setup		invert waveform.....	74
default contents .....	40	Memory depth .....	92
file format .....	93	recall .....	109
how to save.....	100	recall menu tree .....	30
		roll mode.....	69

save .....	101	X-Y mode .....	71
save menu tree.....	32	specification.....	123
x-y mode .....	71	Zoom waveform.....	70
zoom mode.....	70		
Waveform accumulation .....	66		