

High Power Electronic Load

PEL-5000C Series

USER MANUAL



ISO-9001 CERTIFIED MANUFACTURER

GW INSTEK

This manual contains proprietary information, which is protected by copyright. All rights are reserved. No part of this manual may be photocopied, reproduced or translated to another language without prior written consent of Good Will company.

The information in this manual was correct at the time of printing. However, Good Will continues to improve products and reserves the rights to change specification, equipment, and maintenance procedures at any time without notice.

Good Will Instrument Co., Ltd.
No. 7-1, Jhongsing Rd., Tucheng Dist., New Taipei City 236, Taiwan.

Table of Contents

SAFETY INSTRUCTIONS	4
GETTING STARTED.....	8
PEL-5000C Series Introduction	10
Accessories.....	13
Operating Mode Description	15
Operating Area	21
Appearance.....	28
FUNCTION DESCRIPTION	38
Function keys description	39
Test keys description	53
System keys description	67
Test keys description	74
CONNECTION.....	76
Rear Panel	77
Connecting the I-monitor to an oscilloscope	81
Master/Slave Instructions	82
INSTALLATION	85
Check line voltage.....	86
Grounding requirements	86
Power up	87
Connection to the load Input Terminal	87
GPIB & RS232 interface option	88
RS232 interface option	89
GPIB interface option	89
USB interface option	90
LAN interface option	90
I/O connection	91

Load current slew rate setting.....	92
Load wire inductance.....	94
REMOTE CONTROL.....	98
Interface Configuration.....	99
Communication Interface programming command list.....	101
Command Syntax.....	112
Command List.....	114
PRESET Commands.....	116
Limit Commands.....	129
STAGE commands.....	132
System Commands.....	138
Measure Commands.....	140
APPLICATION.....	141
Local sense connections.....	143
Remote sense connections.....	144
Constant Current mode application.....	146
Constant Voltage mode application.....	149
Constant Resistance mode application.....	151
Constant Power mode application.....	153
Applications with current limiting or power limiting function CV mode operation (Charging device).....	155
Applications with current limiting or power limiting function CV mode operation (Discharging device).....	157
Application with switching from CP mode to CV mode operation (battery discharge).....	159
Constant current source operating.....	161
Zero-Volt loading application.....	162
Parallel operation.....	163
Power Supply OCP testing.....	164
Power Supply OPP testing.....	166

SHORT testing	168
Battery discharge test	171
APPENDIX	175
PEL-5000C Default Settings	176
PEL-5000C Dimensions.....	183
PEL-5000C series Specifications	187
Certificate Of Compliance	209
GPIB programming Example.....	210
PEL-5000C series USB Instruction	214
PEL-5000C series Auto-Sequence function provide EDIT, ENTER, EXIT, TEST and STORE 5 keys operation	216
PEL-5000C series LAN Instruction	220

S SAFETY INSTRUCTIONS

This chapter contains important safety instructions that you must follow during operation and storage. Read the following before any operation to insure your safety and to keep the instrument in the best possible condition.

Safety Symbols

These safety symbols may appear in this manual or on the instrument.



WARNING

Warning: Identifies conditions or practices that could result in injury or loss of life.



CAUTION

Caution: Identifies conditions or practices that could result in damage to the instrument or to other properties.



DANGER High Voltage



Attention Refer to the Manual



Earth (ground) Terminal



Frame or Chassis Terminal



Do not dispose electronic equipment as unsorted municipal waste. Please use a separate collection facility or contact the supplier from which this instrument was purchased.

Safety Guidelines

General Guideline



CAUTION

- Do not place any heavy object on the instrument.
Note: Only 2 units can be stacked vertically.
- Avoid severe impact or rough handling that leads to damaging the instrument.
- Do not discharge static electricity to the instrument.
- Use only crimped wires, not bare wires, for the terminals.
- Do not block the cooling fan opening.
- Do not disassemble the instrument unless you are qualified.
- The equipment is not for measurements performed for CAT II, III and IV.

(Measurement categories) EN 61010-1:2010 specifies the measurement categories and their requirements as follows.

- Measurement category IV is for measurement performed at the source of low-voltage installation.
- Measurement category III is for measurement performed in the building installation.
- Measurement category II is for measurement performed on the circuits directly connected to the low voltage installation.
- 0 is for measurements performed on circuits not directly connected to Mains.

-
- Do NOT position the equipment so that it is difficult to disconnect the appliance inlet or the power plug.
 - If the equipment is used in a manner not specified by the manufacturer, the protection provided by the equipment may be impaired.
-

Power Supply



WARNING

- AC Input voltage range: 100-240VAC, Single phase
90-250VAC
 - Frequency: 47-63Hz
 - To avoid electrical shock connect the protective grounding conductor of the AC power cord to an earth ground.
 - To avoid electric shock, the power cord protective grounding conductor must be connected to ground. No operator serviceable components inside. Do not remove covers. Refer servicing to qualified personnel.
-

Cleaning

- Disconnect the power cord before cleaning.
 - Use a soft cloth dampened in a solution of mild detergent and water. Do not spray any liquid.
 - Do not use chemicals containing harsh material such as benzene, toluene, xylene, and acetone.
-

Operation Environment

- Location: Indoor, no direct sunlight, dust free, almost non-conductive pollution (Note below)
- Temperature: 0°C to 40°C
- Humidity: 0 to 85% RH
- Altitude: <2000m
- Overvoltage category II

(Pollution Degree) EN 61010-1:2010 specifies the pollution degrees and their requirements as follows. The instrument falls under degree 2.

Pollution refers to “addition of foreign matter, solid, liquid, or gaseous (ionized gases), that may produce a reduction of dielectric strength or surface resistivity”.

- Pollution degree 1: No pollution or only dry, non-conductive pollution occurs. The pollution has no influence.
 - Pollution degree 2: Normally only non-conductive pollution occurs. Occasionally, however, a temporary conductivity caused by condensation must be expected.
 - Pollution degree 3: Conductive pollution occurs, or dry, non-conductive pollution occurs which becomes conductive due to condensation which is expected. In such conditions, equipment is normally protected against exposure to direct sunlight,
-

precipitation, and full wind pressure, but neither temperature nor humidity is controlled.

Storage environment

- Location: Indoor
 - Temperature: -20°C to 70°C
 - Humidity: <90% RH
-

Disposal



Do not dispose this instrument as unsorted municipal waste. Please use a separate collection facility or contact the supplier from which this instrument was purchased. Please make sure discarded electrical waste is properly recycled to reduce environmental impact.

GETTING STARTED

The PEL-5000C series Electronic Load is designed to test, evaluation and burn-in of DC power supplies and batteries.

The PEL-5000C series high power electronic Load can be controlled locally at the front panel or remotely via computer over the GPIB/RS232/USB/LAN. Constant Current (CC) mode, Constant Resistance (CR) mode, and Constant Voltage (CV) mode. And Constant Power (CP) mode. The wide range dynamic load with independent rise and fall current slew rate and analog programming input with arbitrary wave-form input is available in Constant Current mode.



PEL-5000C Series Introduction	10
Main Features	10
Protection features	11
Accessories	13
Operating Mode Description	15
CC Mode	15
CR mode.....	15
CV mode.....	16
CP mode	16

Slew Rate	16
Dynamic Waveform Definition.....	19
Operating Area	21
Appearance.....	28
Front Panel.....	28
LCD Display	29

PEL-5000C Series Introduction

Main Features

- | | |
|----------|---|
| Features | <ul style="list-style-type: none">• CC, CR, CV, CP, Dynamic, and Short Operating Mode.• Remote control via a choice of computer interfaces.• High accuracy & resolution with 16 bit voltage and current meter.• Built in pulse generators for dynamic loading.• Independently adjustable current rise and fall times.• Short circuit test with current measurement• Dedicated over current and overpower protection test functions• Programmable voltage sense capability.• Full protection from overpower, over-temperature, overvoltage, and reverse polarity.• Analogue programming input for tracking an external signal• Current Monitor with BNC (non-isolated) socket.• Digital Calibration• Advance Fan speed control• Ability to save load setup via the mainframe memory (150 store/recall locations)• Auto sequence function allowing test routines to be set from the mainframe |
|----------|---|

Protection features

The protection features of the PEL-5000C series Electronic load modules are as follows:

Overvoltage protection	<p>The Electronic Load will turn OFF Load OFF if the overvoltage circuit is tripped. The message OVP will be displayed on the LCD. When the OVP fault has been removed the load can be set to sink power again. While the unit will attempt to protect itself given an OVP state it is strongly advised to guard against any potential OVP fault state by using external protection and the correctly rated electronic load.</p> <p>The Overvoltage protection circuit is set at a predetermined voltage and cannot be adjusted. The OVP level is 105% of the PEL-5000C series nominal voltage rating.</p>
------------------------	--



Caution

Never apply an AC voltage to the input of the PEL-5000C series Load. Do not apply a DC voltage that is higher than PEL-5000C series Load rating. If this advice is ignored it is likely that damage will be caused to the electronic load module. This damage will not be covered by the warranty.

Over current protection (OCP)	<p>The PEL-5000C series Electronic Load monitors the current level. The input to the load is automatically switched to LOAD OFF if the current is greater than 104% of the rated current input. If an over current condition occurs the display will show OCP.</p>
Over power protection (OPP)	<p>The PEL-5000C series Electronic Load monitors the power dissipation level. The input to the load is automatically switched to LOAD OFF if the power dissipation is greater than 105% of the rated power input. If an over power condition occurs the display will show OPP.</p>

Over temperature protection The load internal temperature at the heat sink is monitored. If the temperature reaches approximately 90°C the OTP message will be displayed and the unit will automatically switch to the LOAD OFF state. If an OTP error occurs please check the ambient temperature is between 0 to 40°C. Also ensure that the front and rear air vents of the mainframe are not obstructed. The air flow is taken from the front of the mainframe and exhausted from the rear. Therefore a suitable gap needs to be left at the rear of the mainframe. A minimum of 15cm is recommended. After a suitable cooling period the load can be switched.

Reverse Polarity The PEL-5000C series load module will tolerate a reverse current up to the maximum current rating of the load module. The '-' symbol will be shown on the voltage and current displays.



Caution

If a reverse polarity situation occurs the load will sink power even if the LOAD button is OFF. No current will be displayed on the PEL-5000C series load module. Current up to the load's maximum current rating will be tolerated in reverse polarity. However there is no OVP OCP and OPP protection. It is strongly recommended that the load lines be fused if it is likely that the load could be subject to reverse polarity. These fuses should be fast acting and rated at the maximum current of the load module +5%.

Accessories

Standard Accessories	Description	PCs
PEL-5000C series operation manual	It can be downloaded from GW Instek website.	
BANANA PLUGS	Please refer to Fig. 1 on page 14	1
BNC – BNC CABLE	BNC to BNC CABLE, 1m	1
HD-DSUB 15PIN Parallel wire	Parallel Wire	1

Optional Accessories	Description	PCs
GPIB+RS232 interface	PEL-030	1
RS232 interface	PEL-023	1
GPIB interface	PEL-022	1
USB interface + USB driver (The driver can be downloaded from GW Instek website)	PEL-025	
LAN interface + LAN driver (The driver can be downloaded from GW Instek website)	PEL-024	
GPIB cable	GTL-250 GPIB Cable, 0.6m	1
GPIB cable	GTL-248 GPIB Cable, 2m	1
USB cable	GTL-246 USB Cable, 1.2m	1
PEL-5000C, AEL-5006, AEL-5008, AEL-5012 and AEL-5015 handle	PEL-028	1
PEL-5000C Hook Ring	PEL-026	
Rack Mount Kit For PEL-5006C	PEL-027-1	
Rack Mount Kit For PEL-5008C, PEL-5010C, PEL-5012C	PEL-027-2	
Rack Mount Kit For PEL-5015C, PEL-5018C	PEL-027-3	
Rack Mount Kit For PEL-5020C, PEL-5024C	PEL-027-4	

Fig. 1

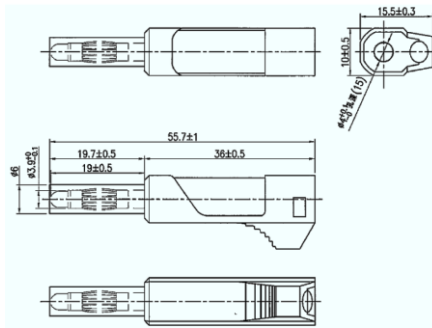

Terminal Dimensions

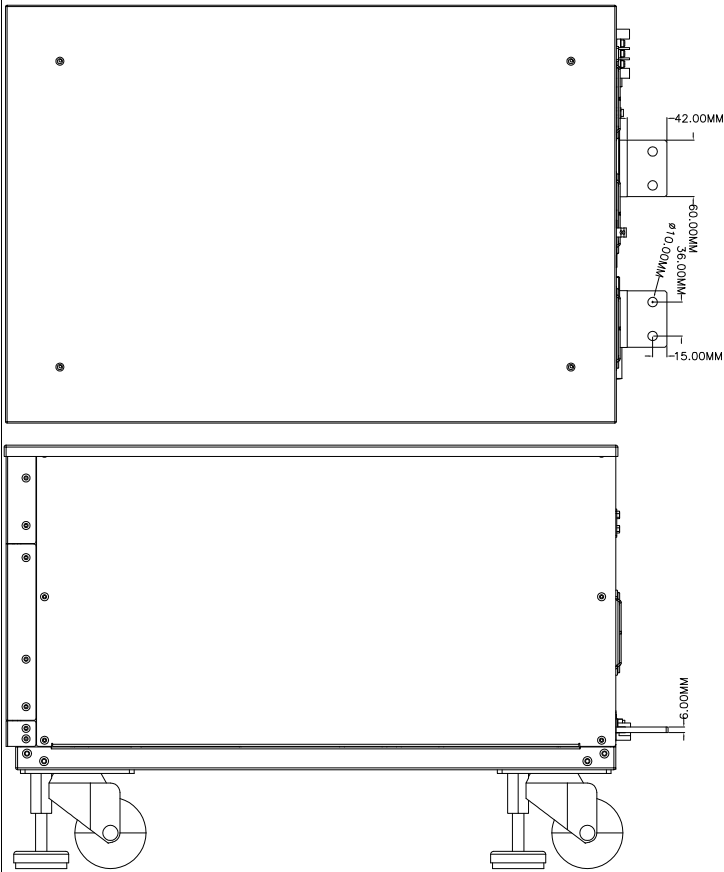

Operating Mode Description

CC Mode

Background

With the operating mode of Constant Current, the PEL-5000C Series electronic load will sink a current in accordance with the programmed value regardless of the input voltage

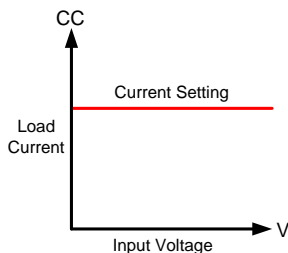

CR mode

Background

At Constant Resistance mode, the PEL-5000C series electronic load will sink a current linearly proportional to the load input voltage in accordance with the programmed resistance setting

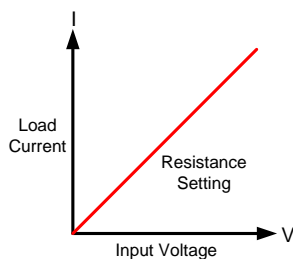

CV mode

Background

At Constant Voltage mode, the PEL-5000C series electronic load will attempt to sink enough current until the load input voltage reaches the programmed value

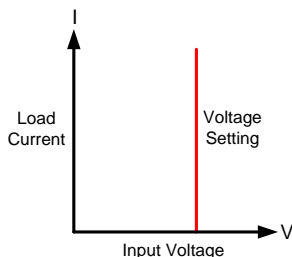

CP mode

Background

At Constant Power mode, the PEL-5000C series electronic load will attempt to sink load power (load voltage * load current) in accordance with the programmed power.

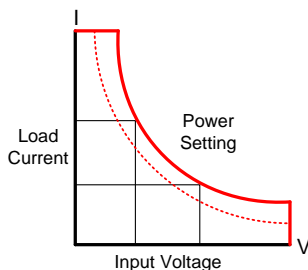

Slew Rate

Background

Slew rate is defined as the change in current or voltage over time. A programmable slew rate allows for a controlled transition from one load

setting to another. It can be used to minimize induced voltage drops on inductive power wiring, or to control induced transients on a test device (such as would occur during power supply transient response testing).

In cases where the transition from one setting to another is large, the actual transition time can be calculated by dividing the voltage or current transition by the slew rate. The actual transition time is defined as the time required for the input to change from 10% to 90% or from 90% to 10% of the programmed excursion.

In cases where the transition from one setting to another is small, the small signal bandwidth (of the load) limits the minimum transition time for all programmable slew rates. Because of this limitation, the actual transition time is longer than the expected time based on the slew rate.

Rise Time Transition Limitation

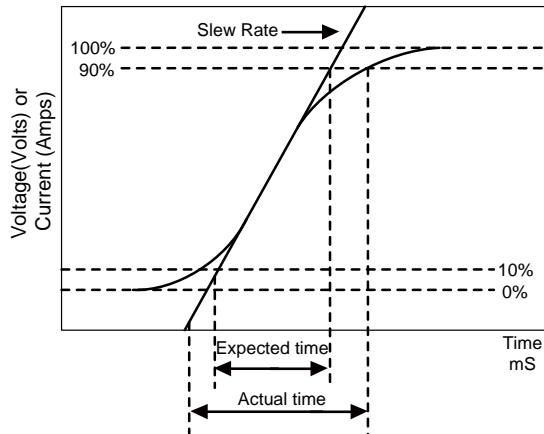

Therefore, both minimum transition time and slew rate must be considered when determining the actual transition time. Following detail description is excluding in specification sheet.

The minimum transition time for a given slew rate as about a 30% or greater load change, the slew rate increases from the minimum transition time to the Maximum transition time at a 100% load change. The actual transition time will be either the minimum transition time, or the total slew time (transition divided by slew rate), whichever is longer.

Example

PEL-5012C-600-840 600V/840A/12000W (CCH - CCL >840A x 30%)

Use the following formula to calculate the minimum transition time for a given slew rate
 min transition time = $252A / \text{slew rate (in amps/second)}$.

$$10.5\mu\text{S} (252A / 24) \times 0.8(10\% \sim 90\%) = 8.4\mu\text{S}$$

Use the following formula to calculate the maximum transition time for a given slew rate
 max transition time = $840 / \text{slew rate (in amps/second)}$.

$$35\mu\text{S} (840A / 24) \times 0.8(10\% \sim 90\%) = 28\mu\text{S}$$

EX. CCH=168A, CCL=0A Slew Rate =24A, the expected time is 5.6uS but the actual Transition

Time Will be limited to 4.8Us.

$$7\mu\text{S} (168 / 24 \times 0.8(10\% \sim 90\%)) = 5.6\mu\text{S}$$



Note

When CC mode rang1 slew rate, CCL setting at least 0.1% larger than the specification.

Dynamic Waveform Definition

Background

Along with static operation the PEL-5000C series electronic load are built with a dynamic mode for operation in Constant Current (CC), Constant Resistance (CR) or Constant Power (CP). This allows the test engineer to simulate real world pulsing loads or implement a load profile that varies with time.

A dynamic waveform can be programmed from the front panel of the PEL-5000C electronic load. The user would first set a High and low value of load current using the Level button. The Dynamic Setting then allows for the rise and fall time between these 2 current values to be adjusted. The time period that the waveform is high (Thigh) along with the time period that the waveform is low (Tlow) can also be set.

Dynamic Waveform

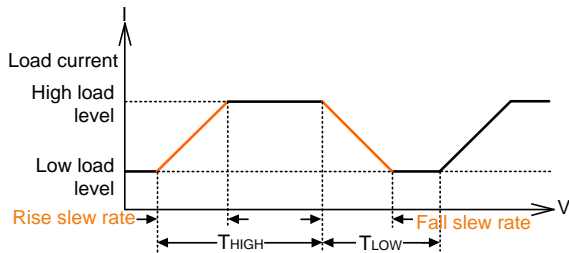

The dynamic waveform can also be set up via the optional computer interface. Dynamic waveform settings made from the front panel of the load module can also be saved in the memory of the PEL-5000C series Electronic Load. For the store/recall procedure and the computer command set please refer to the relevant operating manual for the PEL-5000C series Electronic Load.

Further dynamic waveform definitions are:

- The period of dynamic waveform is $T_{high} + T_{low}$
- The dynamic frequency = $1 / (T_{high} + T_{low})$
- The duty cycle = $T_{high} / (T_{high} + T_{low})$

Example 1

PEL-5000C series, Dynamic up to 50 kHz frequency

Dynamic highest frequency 50 kHz = 0.02ms=20us

Setting THIGH=10 uS, TLOW=10uS,
THIGH+TLOW=20uS

$CCH-CCL/SR \leq 10uS$

Setting CCH=30A, CCL=10A

$(30-10)/2.5A/uS \leq 10 uS$

$8 uS \leq 10 uS$,Compliance with frequency 50kHz

Example 2

Setting THIGH=10 uS, TLOW=10uS,
THIGH+TLOW=20uS

$CCH-CCL/SR \leq 10uS$

Setting CCH=50A, CCL=0A

$(50-0)/2.5A/uS=20uS$, $20uS > 10uS$, It's not compliance the frequency 50 kHz

The analogue programming input also provides a convenient method of implementing a dynamic waveform.

Operating Area

The PEL-5000C series electronic load can be operated for manual and GPIB operation.

The PEL-5000C series high power electronic Load can be controlled locally at the front panel or remotely via computer over the GPIB/RS232/USB/LAN. Constant current (CC) mode, constant resistance (CR) mode, and constant voltage (CV) mode and constant power (CP) mode. The wide range dynamic load with independent rise and fall current slew rate and analog programming input with arbitrary wave-form input is available in Constant Current mode.

PEL-5006C-150-600
power contour

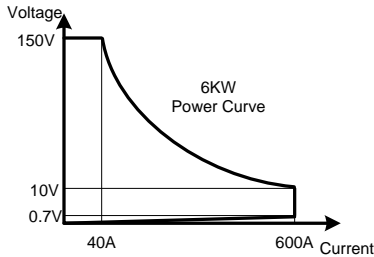

PEL-5008C-150-800
power contour

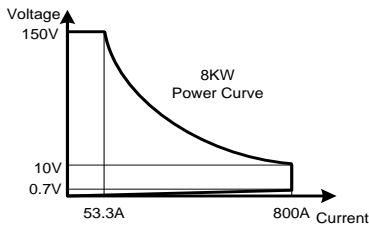

PEL-5010C-150-1000
power contour

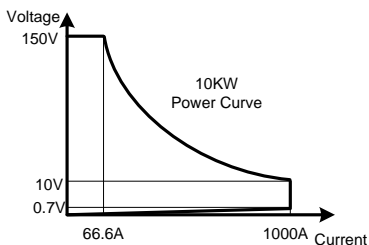

PEL-5012C-150-1200
power contour

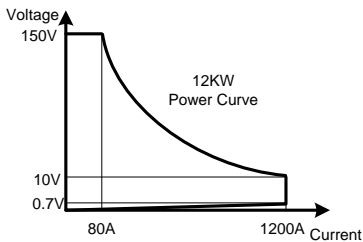

PEL-5015C-150-1500
power contour

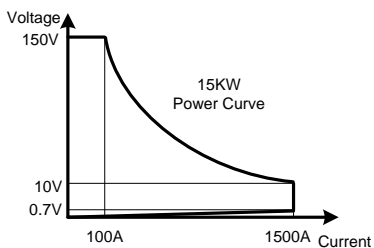

PEL-5018C-150-1800
power contour

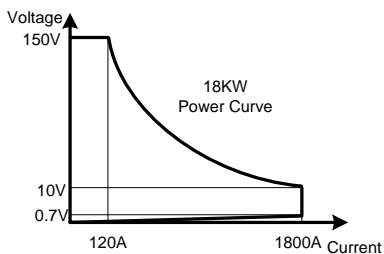

PEL-5020C-150-2000
power contour

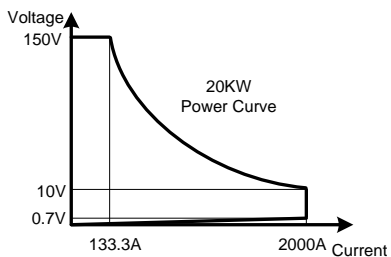

PEL-5024C-150-2000
power contour

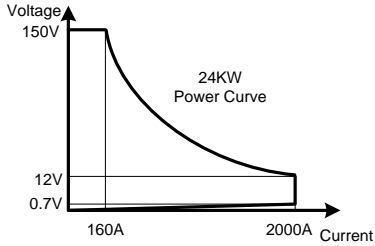

PEL-5006C-600-420
power contour

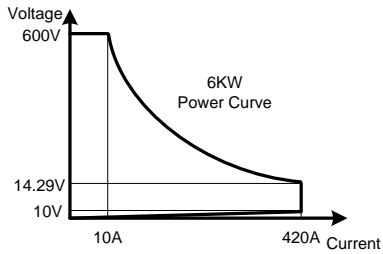

PEL-5008C-600-560
power contour

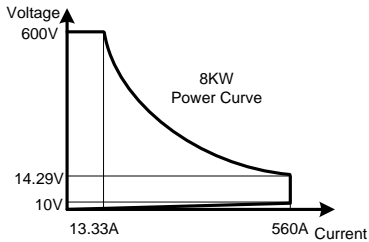

PEL-5010C-600-700
power contour

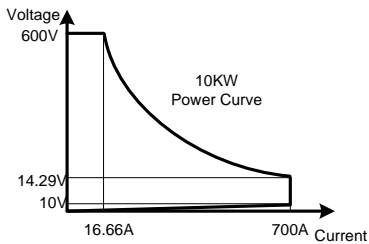

PEL-5012C-600-840
power contour

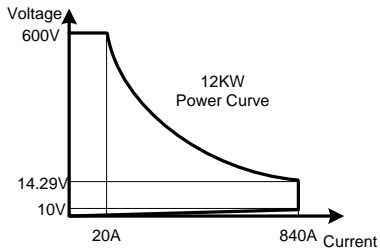

PEL-5015C-600-1050
power contour

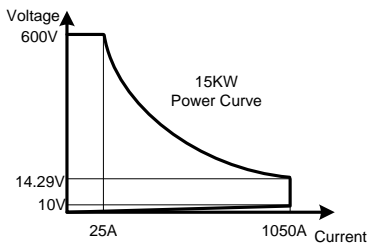

PEL-5018C-600-1260
power contour

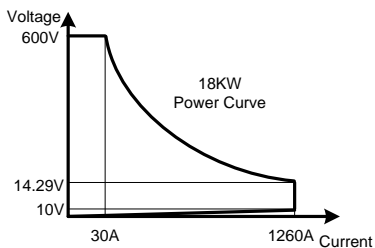

PEL-5020C-600-1400
power contour

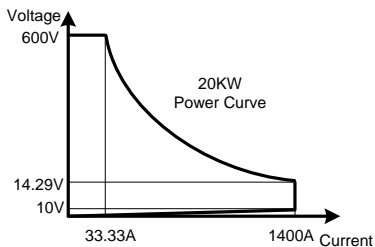

PEL-5024C-600-1680
power contour

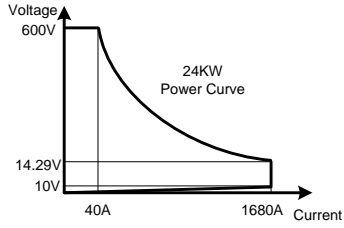

PEL-5006C-1200-240
power contour

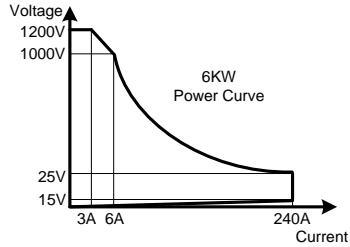

PEL-5008C-1200-320
power contour

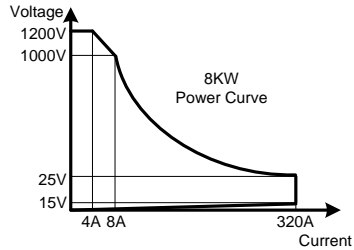

PEL-5010C-1200-400
power contour

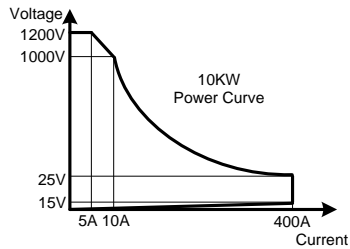

PEL-5012C-1200-480
power contour

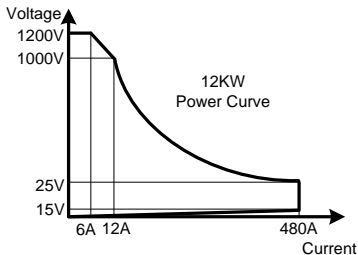

PEL-5015C-1200-600
power contour

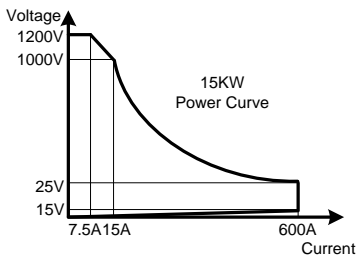

PEL-5018C-1200-720
power contour

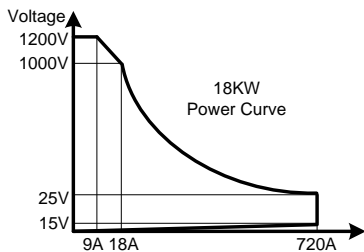

PEL-5020C-1200-800
power contour

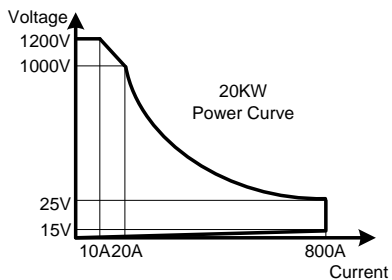

PEL-5024C-1200-960
power contour

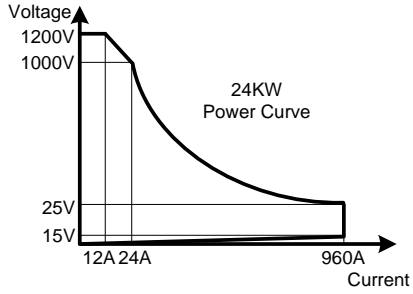

Appearance

Front Panel

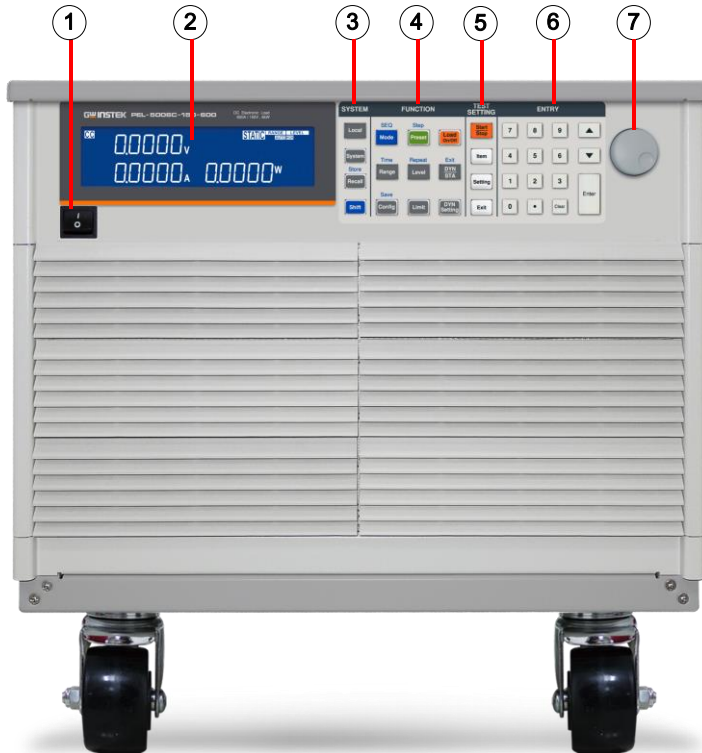

- 1 Power switch
- 2 LCD Multi-function display
- 3 System keys
- 4 Function keys
- 5 Test function keys
- 6 Number keypad
- 7 Knob setting

LCD Display

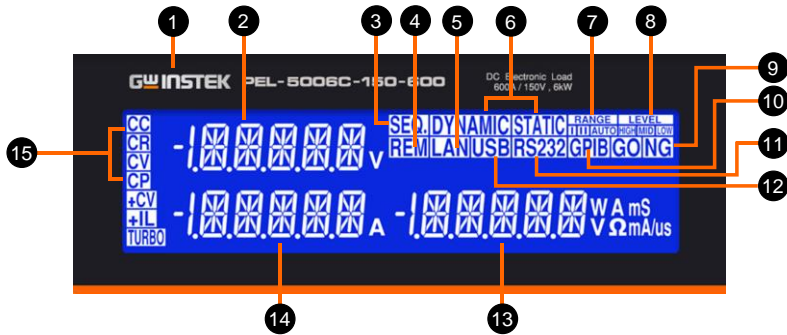

- | | |
|--|--|
| <p>1 Model number and sink ranges</p> | <p>The model number along with maximum voltage, current and power values are detailed in this position at the top of the load front panel.</p> |
| <p>2 Left 5 digit LCD display</p> <p>Normal mode</p> | <p>The 5 digit LCD display is a multi-function display. The function of the display changes depending whether the user is in NORMAL mode or in a SHORT, OPP or OCP modes:</p> <p>Status display:
When enter System Setting or AUTO SEQUENCE, the display setting item.</p> <p>The left 5 digit display displays the voltage present at the load’s input terminals. The value displayed will include the automatic voltage compensation if the sense terminals are also connected to the device under test (DUT).</p> |

 Note

If V-sense is set to “AUTO” and the sense leads are connected to the DUT the losses need to be approx. 1.75V (PEL-50xxC-150-xxxx), 7.0V(PEL-50xxC-600-xxxx), 14V(PEL-50xxC-1200-xxx) before the display compensates for the voltage loss.

If V-sense is set to “ON” and the sense terminals are connected to the DUT the load will check and compensate for all voltage drops.

Test mode	<p>If the SHORT, OPP or OCP buttons are pressed the left display will show a text Message that correlates with the selected test function.</p> <ul style="list-style-type: none">• SHORT test selected: left display will show "Short".• OPP test selected: left display will show "OPP".• OCP test selected: left display will show "OCP". <p>During the test the left display will show the load Input voltage.</p>
3 SEQ. indicator	<p>When entering AUTO SEQUENCE mode, LCD indicator will light up.</p>
4 REM LCD Indicator	<p>If the REMOTE LCD Indicator is illuminated this means that the unit is operating remotely via one of the optional interfaces. While REMOTE is lit it is not possible to make settings manually at the front panel. The LOCAL button on the mainframe can be used to revert back to front panel control. When the unit is operating from the front panel the REMOTE LCD will not be illuminated.</p>
5 LAN mode Lit	<p>It is LAN interface inside.</p>
6 DYN/STA LED Indicator	<p>The DYN button allows the user to switch between DYNAMIC operation and STATIC operation. Dynamic operation is only possible in constant current (CC) or Constant power (CP) mode only. The LED next to the DYN button will become lit When DYNAMIC operation is selected. If you are in constant resistance (CR) or Constant voltage (CV) mode pressing the DYN button will have no effect</p>

-
- 7 Rang LED Indicator
- The PEL-5000C series Load Module features 2 setting ranges for CC, CR, CV & CP operation. This allows improved resolution for setting low values. When left in the default AUTO mode the changeover between ranges is automatic depending on the setting value entered.

If desired the RANGE button can be pressed to force the unit to operate only in ANGE II. This is signaled by the accompanying LED becoming lit.



That it is only possible to force RANGE II in CC mode.

-
- 8 Level LED Indicator
- The LEVEL button is used to program a High or Low load value. The setting value changes between current, resistance, voltage or power depending whether CC, CR, CV or CP mode has been selected. If the LED is lit then the High level value setting has been enabled. If the LED is not lit then the low load level can be set using the rotary switch in combination with the arrow keys.

In STATIC mode the user can switch between High and low load levels during operation.

In DYNAMIC operation (CC & CP modes only) the preset high and low levels are used to define the dynamic waveform.



The low level setting cannot exceed the high level. The converse is also true in that the High level cannot be set below the low level.

-
- 9 NG LCD Indicator
- The user can adjust upper and lower limits for voltage, current and power within the CONFIG menu and turn the NG Indicator ON. If a voltmeter, ammeter or wattmeter measurement is outside these set limits then the NG indicator will illuminate.
-

10 GPIB mode Lit	It is GPIB inside. The LCD will be lit GPIB when Power ON. If PEL-5000C series is controlled by GPIB through PC, the GPIB will be lit.
11 RS232 mode Lit	It is RS232 inside. The LCD will be lit RS232 when Power ON. If PEL-5000C series is controlled by RS232 through PC, the RS232 will be lit.
12 USB mode Lit	It is USB interface inside.
13 The right 5 digit displays	<p>The right 5 digit displays also changes function depending if the unit is in normal mode or one of the setting menus has been activated.</p> <p>Setting display: Display System Setting state or AUTO SEQUENCE setting value.</p> <p>Normal mode In normal mode the right 5 digit displays shows the power consumption in Watts (W).</p> <p>Setting mode The right display together with the rotary adjustment knob is used to set values. The value changes according to the setting function that is active. The middle LCD provides a text message to tell the user which part of the setting menu is active.</p>
14 Middle 5 digit LCD display	<p>The middle 5 digit displays also changes function depending if the user is in normal mode or has entered a setting menu</p> <p>Status display: When enter System Setting or AUTO SEQUENCE, the display setting item.</p> <p>Normal mode In normal mode the middle LCD display functions as a 5 digit ammeter. The 5 digit DAM shows the load current flowing into the DC load when the Load is ON.</p>

Setting mode If CONFIG, LIMIT, DYN, SHORT, OPP or OCP buttons are pressed the middle LCD show a text message according to the setting function it is in. Each subsequent press of the button moves the display to the next available function.

The sequence of each setting menu is detailed below

- CONFIG:
Sequence is "SENSE" → "LDon" → "LDoff"
→ "POLAR" → "MPPT" → "CPRSP"
→ "AVG" → "FAN"
- LIMIT:
Sequence is "Add.CV" → "V_Hi" → "V_Lo"
→ "I_Hi" → "I_Lo" → "W_Hi" → "W_Lo"
→ "NG"
- DYN setting:
Sequence is "T-Hi" → "T-Lo" → "RISE" →
"FALL"
- SHORT:
Sequence is "PRESS" → "TIME" → "V_Hi"
→ "V_Lo"
- OPP:
Sequence is "PSTAR" → "PSTEP" →
"PSTOP" → "Vth"
- OCP:
Sequence is "ISTAR" → "ISTEP" → "ISTOP"
"Vth"

PRESET mode The value of the setting entered on the right display changes depending on the operating MODE that has been selected.

- If CC mode is selected the right display provides setting in amps "A".
- If CR mode is selected the right display provides setting in ohms "Ω".
- If CP mode is selected the right display

provides setting in watts "W".

- If CV mode is selected the right display provides setting in volts "V".

LIMIT

Each press of the LIMIT button changes the middle LCD text. The sequence and the corresponding setting value shown on the bottom display is as follows:

Set CC + CV or CP + CV upper limit voltage, the middle of the display show "Add.CV", right display set value, the unit is V.

- V_Hi (left limit voltage) displays the set value in volts "V".
- V_Lo (right limit voltage) displays the set value in volts "V".
- I_Hi (left limit current) displays the set value in amps "A".
- I_Lo (right limit current) displays the set value in amps "A".
- W_Hi (left limit power) displays the set value in watts "W".
- W_Lo (right limit power) displays the set value in watts "W".
- NG displays whether the NG flag is set to "ON" or "OFF".

DYN Setting

Each press of the DYN setting button changes the text on the middle LCD. The sequence and the corresponding setting value shown on the bottom display are as follows:

- T-Hi (time high) displays the set value in milliseconds "ms".
- T-Low (time low) displays the set value in milliseconds "ms".
- Rise (current rise time/slew rate) displays the set value in "A/us" or "A/ms".
- Fall (current fall time/slew rate) displays the set value in "A/us" or "A/ms".

CONFIG	<p>Each press of the CONFIG button changes the right upper LCD Text.</p> <p>The sequence and the corresponding setting value shown on the bottom displays are as follows:</p> <ul style="list-style-type: none">• SENSE can be set to "AUTO" or "ON"• LDon (load ON voltage) displays the set value in volts "V"• LDoff (load OFF voltage) displays the set value in volts "V"• POLAR (load polarity) can be set to "+LOAD" or "-LOAD"• MPPT (Maximum power point tracking)• BATT1 (Battery Discharge)• BATT2 (Battery Discharge)• BATT3 (Battery Discharge)• CPRSP (CP RESPONSE)• AVG• FAN• Exit CONFIG options
SHORT test	<p>This allows the parameters of the short test to be set up.</p> <p>Each press of the SHORT button moves the setting function. The sequence of the short test along with the setting value is as follows:</p> <ul style="list-style-type: none">• Short Press Start (pressing the START/STOP button starts the test).• TIME shows the duration of the SHORT test. "CONTI", on the bottom display indicates continuous. Time can be adjusted in "ms".• V-Hi (voltage high threshold) displays the set value in volts "V"• V-Lo (voltage low threshold) displays the set value in volts "V"

When the test is started the right display will show RUN. When the test has finished the right display will show END.

OPP test

This allows the parameters of the over power protection test to be set up. Each press of the OPP button moves the setting function. The sequence of the OPP test along with the setting value is as follows:

- OPP Press Start (pressing the red START/STOP button starts the test)
- PSTAR (power start point) right display provides setting in watts "W"
- PSTEP (power steps) right display provides setting in watts "W"
- PSTOP (power stop point) right display provides setting in watts "W"
- VTH (voltage threshold) right display provides setting in volts "V"

When the test is started the right display will show the power value being taken by the load. If the Device Under Test is able to supply the load according to the values set then the right display will show PASS and the right display will show the maximum power taken during the OPP test. If during the test, OTP is displayed the over temperature protection has been engaged. Similarly if OPP is shown on the display the over power protection has been activated.

OCP test

This allows the parameters of the over current protection test to be set up. Each press of the OCP button moves the setting function.

The sequence of the OCP test along with the setting value is as follows:

- OCP Press Start (pressing the red START/STOP button starts the test)

- ISTAR (current start point) right display provides setting in amps "A"
- ISTEP (current steps) right display provides setting in amps "A"
- ISTOP (current stop point) right display provides setting in amps "A"
- VTH (voltage threshold) right display provides setting in volts "V"

FUNCTION DESCRIPTION

Function keys description	39
Test keys description	53
System keys description.....	67
Test keys description	74

Function keys description

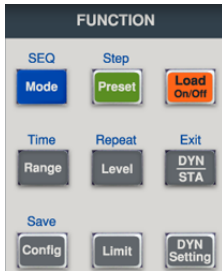

Mode and CC,
CR, CP, CV
Indicator



There are four operating modes. These can be selected in turn by pressing the “MODE” key on the PEL-5000C series Electronic Load module. The sequence is:

- (CC) Constant Current
- (CR) Constant Resistance
- (CP) Constant Power
- (CV) Constant Voltage

The appropriate LCD will illuminate according to the operating mode is selected.

Load key and
LED
indicators



The input to the PEL-5000C Series electronic load can be switched ON/OFF by using the “LOAD” button. Indication of the ON/OFF state is provided by illumination of the button.

LOAD button lit = LOAD ON (load sinks according to the preset values)

LOAD button unlit = LOAD OFF (the load does not sink current)

Turning the LOAD OFF does not affect the preset values. When the LOAD ON state is enabled the unit will revert to sinking according to the preset values.

When the Load ON/OFF key is operated

the current taken by load will follow the RISE or FALL with time according to the preset rate. The current RISE and FALL times can be adjusted in the DYN Setting button of the front panel.

In addition to the LOAD ON/OFF function the user can also adjust the voltage level at which the unit will automatically start or stop sinking energy. The adjustable LDon and LDoff voltage levels are found within the CONFIG menu.



Note

The LDoff level cannot be set higher than the LDon level.

Preset key and
LED
indicators



If the PRESET key is pressed the button will become lit indicating that the PRESET mode has been accessed. The lowest 5 digit display will change from showing the power consumption in watts to displaying the value to be preset. The value that can be programmed changes according to the operating mode that has been selected.

- Constant Current (CC) mode:
The A and B levels of load current can be preset at right lower 5 digit LCD. The "A" LED will be lit indicating the setting value is amps.
- Constant Resistance (CR) mode:
The A and B levels of load resistance can be preset on the right lower 5 digit LCD. The "Ω" LED will be lit indicating the setting value is ohms.
- Constant Voltage (CV) mode:
The A and B levels of load voltage can be preset on the right lower 5 digit LCD. The "V" LED will be lit indicating the setting value is volts.

- Constant Power (CP) mode:
The A and B levels of load power can be preset on the right lower 5 digit LCD. The “W” LED will be lit indicating the setting value is watts.
- Dynamic mode (CC, CR or CP modes only):

Preset key



Each press of the DYN button cycles through the dynamic load settings. The DYN settings are used in conjunction with the High and Low levels of load current to define the dynamic waveform. Each press of the DYN button switches from T_Hi (time high), to T_Lo (time low), to Rise time and then to fall time. The middle LCD shows the section of the dynamic waveform which is programmed with the rotary knob and read from the right display. The “ms” LED shows that the settings are programmed in milliseconds.

Range key



The PEL-5000C series Load Module features 2 setting ranges for CC, CR, CV & CP operation. This allows improved resolution for setting low values. When left in the default AUTO mode the changeover between ranges is automatic depending on the setting value entered.

If desired the RANGE button can be pressed to force the unit to operate only in RANGE II. This is signaled by the accompanying LED becoming lit.



Note

It is only possible to force RANGE II in CC mode.

Level key

Level

The LEVEL button is used to program a High or Low load value. The setting value changes between current, resistance, voltage or power depending whether CC, CR, CV or CP mode has been selected. If the LED is lit then the High level value setting has been enabled. If the LED is not lit then the low load level can be set using the rotary switch in combination with the arrow keys.

In STATIC mode the user can switch between High and low load levels during operation.

In DYNAMIC operation (CC & CP modes only) the preset high and low levels are used to define the dynamic waveform.



Note

The low level setting cannot exceed the high level. The converse is also true in that the High level cannot be set below the low level.

Limit key

Limit

The LIMIT button allows the user to set left and right thresholds for voltage, current or power. These threshold settings are used in conjunction with the NG function to flag when the load is operating outside the desired limit.

Each press of the LIMIT key enables a different value to be entered. On first press of the LIMIT key the button will illuminate. Add.CV will be displayed on the middle LCD. The setting is made with the rotary knob and can be read from the right LCD during setting.

The setting sequence is shown below:

- Add.CV (CC+CV or CP+CV upper limit)
- V_Hi (DVM upper limit)

- V_Lo (DVM lower limit)
- I_Hi (DAM upper limit)
- I_Lo (DAM lower limit)
- W_Hi (DWM upper limit)
- W_Lo (DWM lower limit)
- NG OFF/ON (No Good Flag)
- LIMIT setting function OFF

The engineering unit is "V", "A" or "W" depending on the threshold LIMIT being set.

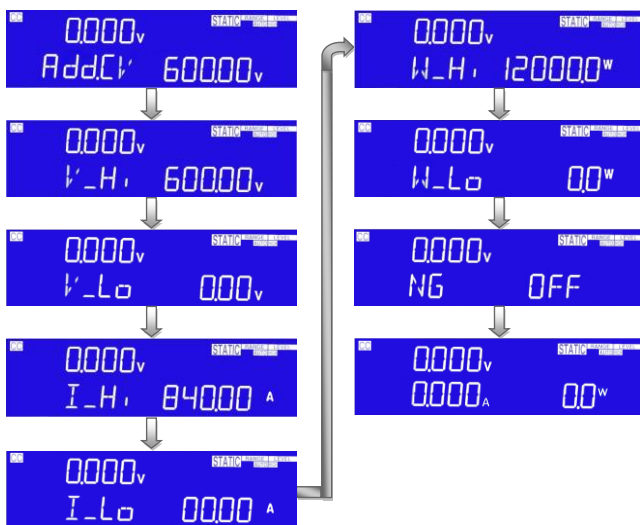

Setting CC+CV or CP+CV upper limit voltage, Middle 5 digit LCD display "Add.CV", right 5 digit LCD display the unit is "V", The Add.CV set range from 0.00 V to 600.00V step 0.01V by rotating the Setting knob.

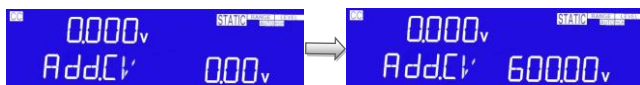

Setting upper limit voltage V_H , Middle 5 digit LCD display "V-Hi", right 5 digit LCD display the unit is "V", The V-Hi set range from 0.00 V to 600.00V step 0.01V by rotating the Setting knob.



Setting lower limit voltage V_L , the right upper 5 digit monitor display "V-Lo" and right lower monitor display lower limit of the voltmeter with the unit as "V", The V-Lo set range from 0.00 V to 600.00V step 0.01V by rotating the Setting knob.

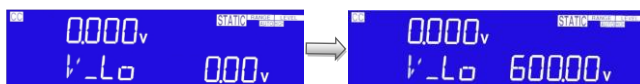

Setting upper limit current I_H , the right upper 5 digit monitor display "I-Hi" and right lower monitor display upper limit of the voltmeter with the unit as "A", the I-Hi set range from 0.000 A to 840.00A step 0.0001A by rotating the Setting knob.

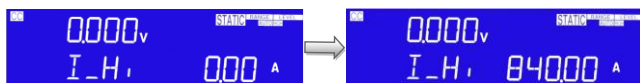

Setting lower limit current I_L , the right upper 5 digit monitor display "I-Lo" and right lower monitor display lower limit of the voltmeter with the unit as "A", the I-Lo set range from 0.000 A to 840.00A step 0.01A by rotating the Setting knob.

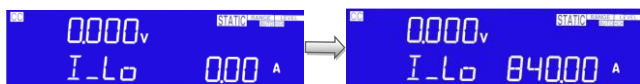

Setting upper limit power WH, the right upper 5 digit monitor display "W-Hi" and right lower monitor display upper limit of the voltmeter with the unit as "W", the W-Hi set range from 0 W to 12000W step 1W by rotating the Setting knob.



Setting lower limit power WL, the right upper 5 digit monitor display "W-Lo" and right lower monitor display lower limit of the voltmeter with the unit as "W", the W-Lo set range from 0 W to 12000W step 1W by rotating the Setting knob.

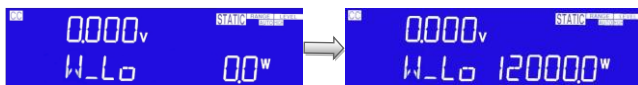

Setting NG ON/OFF, When exceed VH, VL, IH, IL, WH, WL One of these whether NG on LCD display.

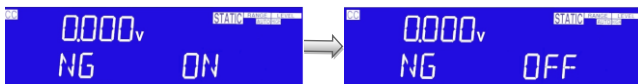

Limit

CC mode, press limits key to set the V-Hi and V-Lo voltage upper and lower limits of the GO / NG.

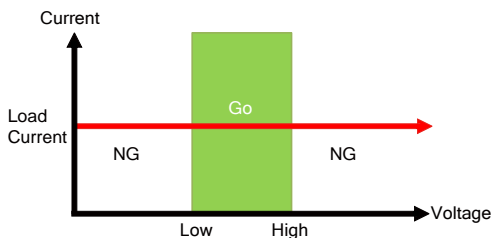

Limit

CC Dynamic Mode, press key to set the Level Hi and Level Low voltage upper and lower limits of the GO / NG.

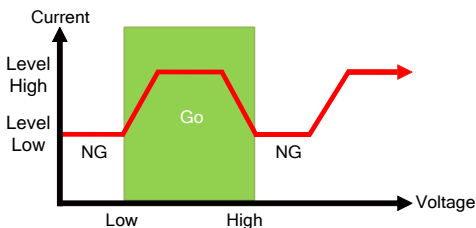

Limit

CR mode, press limits key to set the V-Hi and V-Lo voltage upper and lower limits of the GO / NG.

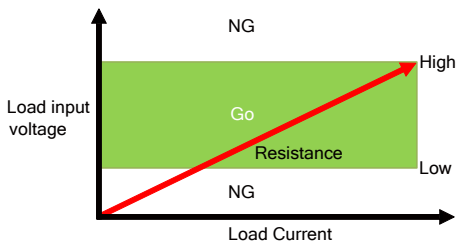

Limit

CV mode, press limits key to set the I-Hi and I-Lo Current upper and lower limits of the GO / NG.

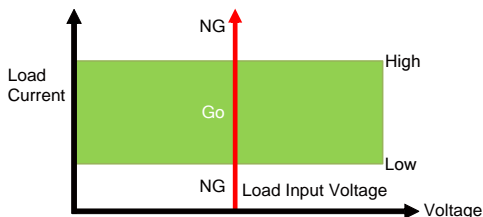

Limit

CP mode, press limits key to set the W-Hi and W-Lo power upper and lower limits of the GO / NG.

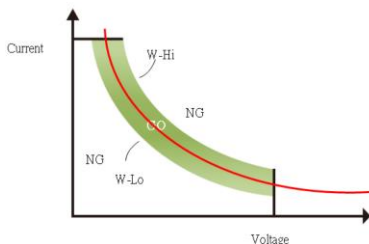

DYN setting
key

DYN
Setting

The DYN button allows the user to define the timings of the dynamic load Waveform. Firstly the high and low levels of load current will need to be set via the LEVEL switch. The RISE and FALL times between the low load current and the high load current along with the TIME the waveform is HIGH and the TIME LOW can be set via the DYN menu.

Each press of the DYN key enables a section of the DYNAMIC waveform to be set.

On first press of the DYN key the button will illuminate and T-Hi will be displayed on the middle LCD. The value is adjusted with the rotary knob and can be read from the right LCD during setting.

The setting sequence is shown below:

- T_Hi (time the waveform is high)
- T_Lo (time the waveform is low)
- RISE (rise time)
- FALL (fall time)
- DYN setting function OFF

The time that the waveform is high includes the rise time and is set in "ms".

The time that the waveform is low includes the fall time and is set in "ms".

The RISE and FALL time is set in "A/ μ s".

The actual engineering unit is shown on the right of the Right 5 digit display



Press DYN setting key, LED will ON setting level High Period, Middle 5 digit LCD display will show "T-Hi" Right 5 digit LCD display will show setting value, the unit is "ms", the T-Hi set range from 0.010 ms to 9999 ms step 0.001ms by rotating the setting knob.

There are four ranges from 0.010 ms to 9999 ms, the ranges are below:

- Range 1:0.010ms~9.999ms
- Range 2:10.00ms~99.99ms
- Range 3:100.0ms~999.9ms
- Range 4:1000ms~9999ms

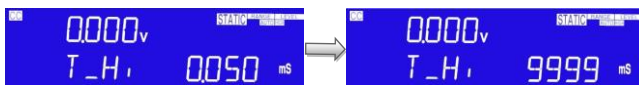

Setting level Low period, Middle 5 digit LCD display will show "T-Lo", right 5 digit LCD display will show setting value, the unit is "ms", the T-Lo set range from 0.010 ms to 9999 ms step 0.001ms by rotating the Setting knob.

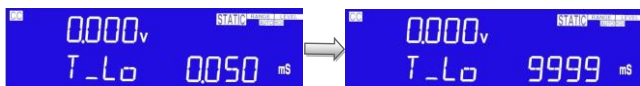

Setting rise time, Middle 5 digit LCD display will show "RISE", right 5 digit LCD display will show setting value, the unit is "A/ μ s", the RISE time set range from 0.672A/ μ s to 42.840 A/ μ s step 0.168A/ μ s by rotating the Setting knob.

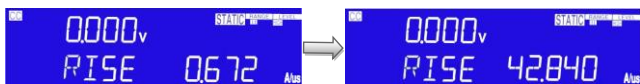

Setting fall time, Middle 5 digit LCD display will show "FALL", right 5 digit LCD display will show setting value, the unit is "A/ μ s", the FALL time set range from 0.672A/ μ s to 42.840A/ μ s step 0.168A/ μ s by rotating the Setting knob.

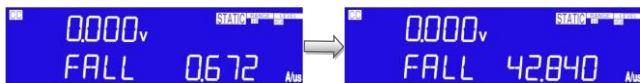

Config key

Config

The CONFIG key allows the sense function to engage automatically or switched ON. The CONFIG key also enables the LOAD to automatically turn ON/OFF when a voltage level is reached. The polarity symbol can also be switched via the CONFIG menu.

Each press of the CONFIG key moves the menu on one step. On first press of the CONFIG key the button will illuminate and EXTIN will be displayed on the Right upper LCD. The value is adjusted with the rotary knob and can be read from the right LCD during setting. The setting sequence is shown below:

- SENSE (AUTO or ON)
- LDon (Voltage at which LOAD turns

ON)

- LDoff (Voltage at which LOAD turns OFF)
- POLAR (change polarity symbol)
- MPPT
- CPRSP
- AVG
- FAN
- Exit CONFIG options

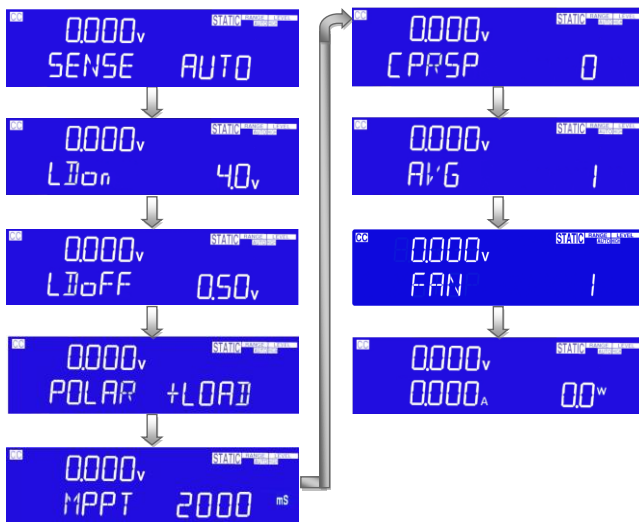

Note

- The adjustable LDOn (LOAD ON) voltage is valid for CC, CR & CP operating modes. The adjusted LDOn voltage will not operate in CV mode.
- The LDOn (LOAD ON) voltage setting cannot be lower than the LDoff (LOAD OFF) voltage. If 0V is required for both LOAD ON and LOAD OFF make the LOAD OFF adjustment first.

Set vsense and load input switching methods, the middle of the 5 digit LCD display will show "SENSE", Right 5 digit LCD display will show "AUTO" or "ON".

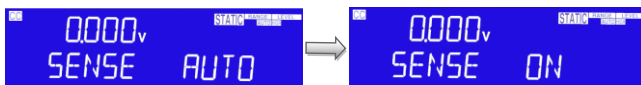

Set Load ON voltage, the middle of the 5 digit LCD display will show “LDon”, Right 5 digit LCD display will show setting value, the units is V, The Load ON Voltage set range from 0.8V to 100.0V step 0.4V by rotating the setting knob. If the load is greater than the input voltage Load ON voltage setting, the Electronic load current begin to load on.

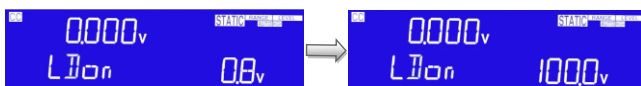

CC/CR/CP MODE is controlled by Load ON voltage, CV MODE is not controlled by Load ON voltage.

Set Load OFF voltage, the middle of the 5 digit LCD display will show “LDoFF”, Right the 5 digit LCD display will show settings value, the units is V, The Load OFF Voltage set range from 0.0V to 99.00V step 0.01V by rotating The Setting knob. If the load input voltage is less than Load OFF setting voltage, the electronic load to load off.

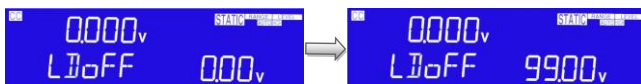

Set Load polarity, the middle of the 5 digit LCD display will show “POLAR”, Right the 5 digit LCD display will show “+ LOAD” or “-LOAD”, use the knobs and key settings “+ LOAD” or “-LOAD”.

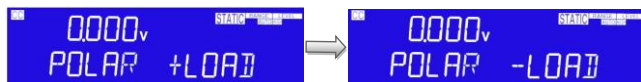

Set MPPT (Maximum power point tracking) testing, the middle of the 5 digit LCD display will show "MPPT", Right the 5 digit LCD display "1000", the MPPT setting range from 1000mS to 60000mS.

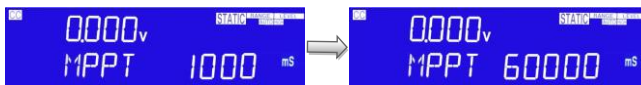

Set CPRSP, the middle of the 5 digit LCD display will show "CPRSP", Right the 5 digit LCD display "0", the CPRSP set range from 0 to 4 steps 1 by rotating the setting knob. Setting CP Mode reaction speed, 0: Fast, 4: Slow.



Set AVG, the middle of the 5 digit LCD display will show "AVG", Right the 5 digit LCD display "1", the AVG setting range from 1 to 64 steps 1 by rotating the setting knob.

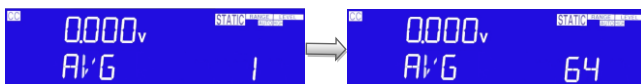

Set FAN, the middle of the 5 digit LCD display will show "FAN", Right the 5 digit LCD display "1", Use the knob and button to set the range 1~3, which can be used to set the operation mode of the cooling fan. "1" is for standard mode, "2" is for increasing speed early and "3" is for full speed.

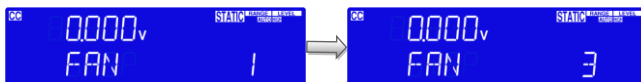

Test keys description



Item, Setting and Exit keys

Item

Setting

Exit

Item, Setting and Exit key for Test. There are eight operating modes. These can be selected in turn by pressing the “Item” “key. Press ITEM key enter setting mode, ITEM LED light ON, the setting sequence is shown below:

- OCP
- OPP
- DISch
- SURGE
- Exit ITEM options

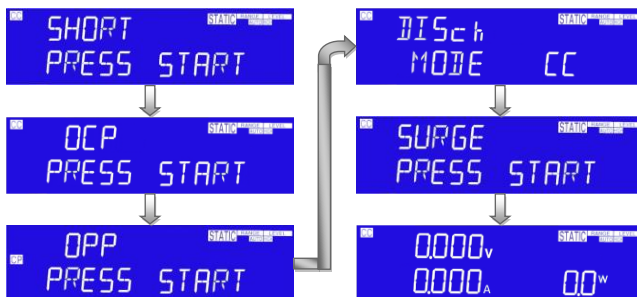

Setting Short mode

The Setting key allows the parameters of a SHORT circuit test to be entered. The SHORT test will attempt to sink high current up to the PEL-5000C series load maximum current in order to check the power source’s protection and behavior.

The test time can be adjusted and threshold values for the High and low voltage limits set.

Setting

Pressing the Setting key once will cause the button to illuminate. The Message "SHORT PRESS START" will be shown across the 3 displays.

Setting

Each press of the SHORT key moves the menu on one step. The left and Middle LCDs show the currently selected test parameter as text. The value is adjusted by the rotary knob and can be read from the right display during Setting.

The setting sequence is shown below:

- SHORT PRESS START (pressing the start/stop key starts test)
- SHORT Time (CONTI = Continuous or 100ms to 10,000ms possible)
- SHORT V_Hi (High voltage threshold setting)
- SHORT V_Lo (Low voltage threshold setting)
- Exit SHORT test set-up

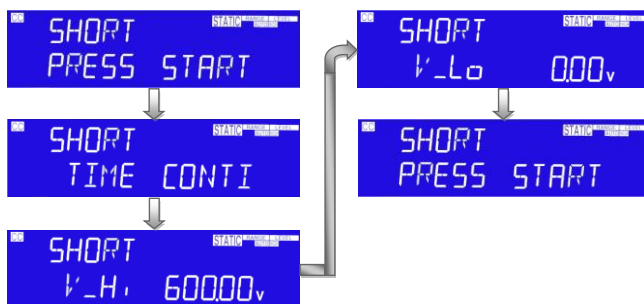

Set the short test time, the LCD display show "SHORT" on left 5 Digits LCD display, shows "TIME" on middle 5 digits LCD display, right 5 digit LCD

display "CONTI", the unit is "ms".



TIME: Set the short test time, The LCD display show "SHORT" on left 5 digits LCD display, shows "TIME" on middle 5 digits LCD display the unit is "ms", and shows "CONTI" on right 5 digits LCD display, the setting range is "CONTI" means continue, 100mS to 10000mS step 100mS by clockwise rotate the setting knob. The short test will be no time limitation when setting to CONTI until press "START/STOP" key to stop the short test.



V-Hi : Short test voltage check upper limitation setting, the LCD display shows "SHORT" on left 5 digit LCD display, Middle 5 digit LCD display "V-Hi", right 5 digit LCD display setting value, the unit is "V", The V-Hi setting range from 0.00V to 600.00V step 0.01V by rotating the setting knob.



V-Lo : Short test voltage check lower limitation setting, the Left 5 digit monitor display the "SHORT", the middle 5 digit monitor display the "V-Lo" and right lower monitor display setting value, the unit is "V". The range is 0.01V to 600.00V.



**Start
Stop**

Once the test parameters have been entered the test is started by pressing the START/STOP button while the SHORT PRESS START text is displayed. During the test the bottom LCD will show run and the actual short current will be displayed on the right upper LCD.



Note

- The message PASS END will be displayed if the measured voltage levels stay within the V_{Hi} and V_{Lo} threshold levels during the test.
- The message FAIL END will be displayed if the measured voltage levels fall outside the V_{Hi} and V_{Lo} threshold levels during the test. The NG flag will also illuminate.
- If continuous short time is selected the test is ended by pressing the red START/STOP button.

OCP
parameters
setting

The OCP key allows the parameters of an Over Current Protection test to be entered. The OCP test will ramp up the load current in steps to validate the Device Under test's (DUT) protection and behavior. A voltage threshold level can be set. If the voltage measured during the test is lower than the set Threshold voltage then the test will fail and the display will signal OCP ERROR. Similarly a current Threshold (I STOP) can be set. If the measured Current reaches the I STOP Threshold the test will be discontinued and the OCP ERROR message will be displayed.

Setting

Press the Setting key once will cause the button to illuminate. The message "OCP PRESS START" will be shown across the 3 displays.

Each press of the OCP button moves the menu on one step. The Left and Middle

LCDs show the currently selected test parameter as text. The value is adjusted by the rotary knob and can be read from the Right display during setting.

The setting sequence is shown below:

- OCP VTH OCP PRESS START (pressing the red start/stop key starts test)
- OCP I STAR (current starting point of the OCP test)
- OCP I STEP (value of incremental current steps from I START)
- OCP I STOP (the OCP test's upper current threshold)
- OCP Vth (the voltage threshold setting)
- Exit OCP test set-up



ISTAR: setting the start current point, the Left 5 digit monitor display the "OCP", the right upper 5 digit monitor display the "ISTAR", and right lower monitor display setting value, the unit is "A". The range is 0.001A to the full scale of the CC mode specification. The setting is by rotating the setting knob.

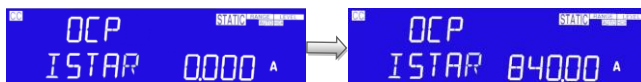

ISTEP: setting the increment step current point, The LCD display shows "OCP" on Left 5 digit LCD display, Middle 5 digit LCD display "ISTEP", right 5 digit LCD display setting value, the unit is "A". The setting range is 0.01A to the full scale of the CC mode specification. The setting is by rotating the setting knob.

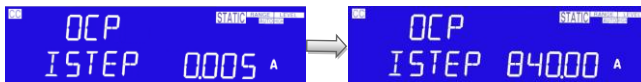

ISTOP: setting the stop current point, The LCD display shows "OCP" on Left 5 digit LCD display, Middle 5 digit LCD display "ISTOP", right 5 digit LCD display setting value, the unit is "A", the setting range is 0.000A to the full scale of the CC mode specification. The setting is by rotating the setting knob.



Vth: Setting threshold voltage; The LCD display shows "OCP" on left 5 Digit LCD display, middle 5 digit LCD display "Vth", right 5 digit LCD Display setting value, the unit is "V", the setting range is 0.00V to the full scale of the voltage specification. The setting is by rotating the setting knob.

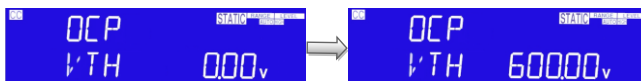

Start
Stop

Once the test parameters have been entered the test is started by pressing the red START/STOP button while the OCP PRESS START text is displayed. During the Test the middle LCD will show run and the actual current being Taken will be displayed on the Right LCD



Note

The message OCP ERROR will be displayed if the DUT fails the test. The reasons for failure are due to one of the following conditions:

- (a) the voltage level of the DUT falls below the set voltage threshold (OCP Vth) during the test
- (b) The current taken from the DUT reaches the OCP I STOP setting.

The message PASS will be displayed if the DUT's voltage stays above the set threshold. Also to PASS the OCP test the current taken from the DUT cannot equal the I STOP setting.

If the DUT passes the OCP test the maximum current taken during the test is displayed on the right LCD.

Upon PASS or OCP ERROR the test will automatically stop. The red START/STOP button can be used during the test to immediately cease operation.

OPP
parameters
setting

The OPP allows the parameters of an Over Power Protection test to be entered. The OPP test will ramp up the load power in steps to validate the Device under test's (DUT) protection and behavior. A voltage threshold level can be set. If the voltage measured during the test is lower than the set Threshold voltage then the test will fail and the display will signal OPP ERROR. Similarly a power threshold (P STOP) can be set. If the measured power reaches the P STOP threshold the test will be discontinued and the OPP ERROR message will be displayed.

Setting

Press the Setting key once will cause the button to illuminate. The message "OPP PRESS START" will be shown across the displays.

Each press of the OPP button moves the menu on one step. The Left and Middle LCDs show the currently selected test parameter as text. The value is adjusted by the rotary knob and can be read from the Right display during Setting.

The setting sequence is shown below:

- OPP PRESS START (pressing the red start/stop key starts test)
- OPP P STAR (power starting point of the OPP test)
- OPP P STEP (value of incremental current steps from P START)
- OPP P STOP (the OPP test's upper threshold power limit)
- OPP Vth (the voltage threshold setting)
- Exit OPP test set-up

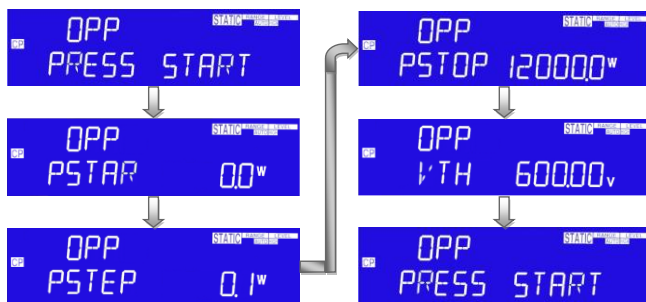

PSTAR: setting the start power, the LCD display shows "OPP" on left 5 digit LCD display, middle 5 digit LCD display "PSTAR", right 5 digit LCD display setting value, the unit is "W", the setting range is 0.00W to the full scale of the CP mode specification. The setting is by rotating the setting knob.

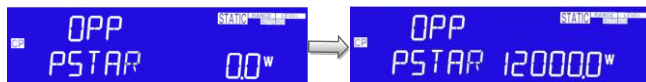

PSTEP: setting the increment step power, the LCD display shows "OPP" on left 5 digit LCD display, middle 5 digit LCD display "PSTEP", right 5 digit LCD display setting value, the unit is "W", the setting range is 0.00W to the full scale of the CP mode specification. The setting is by rotating the setting knob.

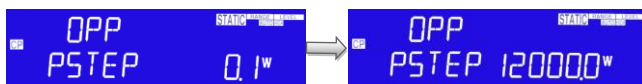

PSTOP: setting the stop power, the Left 5 digit monitor display the "OPP", the right upper 5 digit monitor display the "PSTOP", and right lower monitor display setting value, the unit is "W". The range is 0.1W to the full scale of the CP mode specification.

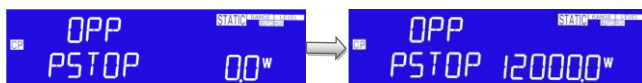

Vth : Setting threshold voltage; the Left 5 digit monitor display the "OPP", the right upper 5 digit monitor display the "Vth", and right lower monitor display setting value, the unit is "V". The range is 0.00V to the full scale of the voltage specification. The setting is by rotating the setting knob.



Start
Stop

Once the test parameters have been entered the test is started by pressing the red START/STOP button while the OPPRESS START text is displayed. During the Test the middle LCD will show run and the actual current being Taken will be displayed on the Right LCD



Note

The message OPP ERROR will be displayed if the DUT fails the test. The reasons for failure are due to one of the following conditions:

- (c) the voltage level of the DUT falls below the set voltage threshold (OPP Vth)during the test
- (d) The current taken from the DUT reaches the OPP P STOP setting.

The message PASS will be displayed if the DUTs voltage stays above the set threshold. Also to PASS the OPP test the current taken from the DUT cannot equal the I STOP setting.

If the DUT passes the OPP test the maximum current taken during the test is displayed on the right LCD.

Upon PASS or OCP ERROR the test will automatically stop. The red START/STOP button can be used during the test to immediately cease operation.

Battery discharge setting

Disch
Mode CC



Disch
Mode CP



DISch the test function has 5 parameters, "CC", "VOLT.V", "TIME.S", "CAP.AH" and CAP.WH parameters.

Press the Setting key to set stop discharge voltage "VOLT.V", Press again Setting key to set stop discharge time "TIMES.S".

Press Setting key again to stop discharge capacity "CAP.AH" / "CAP.WH".

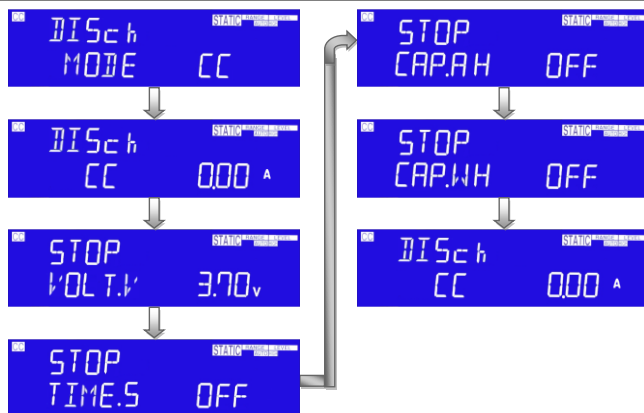

Setting battery discharge CC mode, DISCH CC, LCD show "DISCh", middle 5 digit LCD display "CC", setting range 0.00A to full scale.

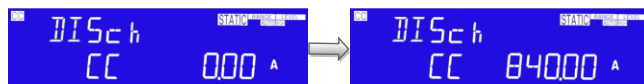

Setting stop discharge voltage STOP "VOLT.V", middle 5 digit LCD display "VOLT.V", right 5 digit LCD display setting value, unit is V, STOP "VOLT.V" setting range 0.00V to full scale.

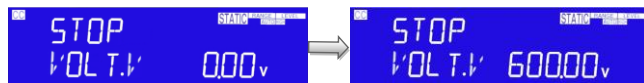

Setting stop discharge time, setting STOP "TIME.S", middle 5 digit LCD display "TIME.S", right 5 digit LCD display setting value, STOP "TIME.S" setting OFF to 99999, each setting knob and button adjustment interval is 1.

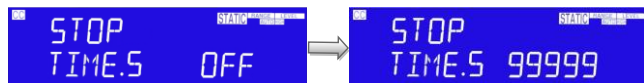

Setting stop discharge capacity, setting STOP "CAP.AH", middle 5 digit LCD display "CAP.AH", right 5 digit LCD display setting value, STOP "CAP.AH" setting range OFF to 19999.9, each setting knob and button adjustment interval is 0.1.

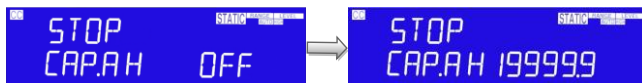

Setting stop discharge capacity, setting STOP "CAP.WH", middle 5 digit LCD display "CAP.WH", right 5 digit LCD display setting value, STOP "CAP.WH" setting range OFF to 19999.9, each setting knob and button adjustment interval is 0.1.

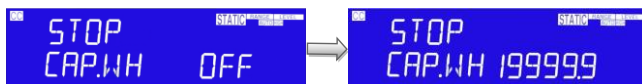

Surge current testing setting



SURGE sequence is shown below:

SURGE the test function has 4 parameters, "SUR.I", "NOR.I", "TIME" and "STEP" parameters.

- Press the Setting key to set surge current testing loading current value "SUR.I".
- Press again Setting key to set normal current testing loading current value "NOR.I".
- Press Setting key again to set surge current testing time "TIME".
- Press the Setting key again to set surge current testing diminishing step current setting value "STEP".

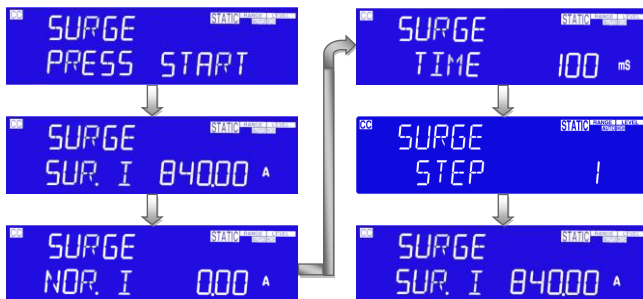

Set SURGE testing surge current, unit is A, setting range 0.00A to full scale.

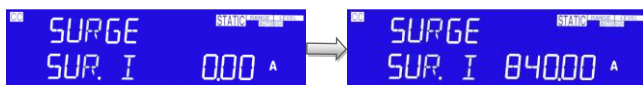

Set SURGE testing normal current, unit is A, setting range 0.00A to full scale.

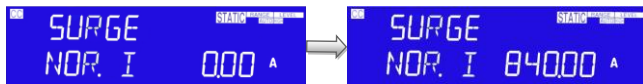

Set SURGE time, unit is mS, setting range 10mS to 1000mS.

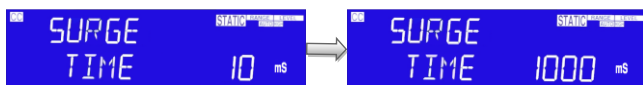

Set SURGE step, setting range 1 to 5.



Setting fig explanation.

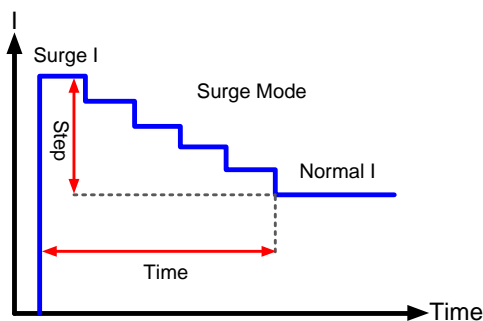

Exit Key

Exit

Setting OCP / OPP / DISch / SURGE during the setting process press Exit key to exit setting item.

Start/Stop key

Start
Stop

The START/STOP key is used in conjunction with the SHORT, OCP or OPP test functions. It is used to START a test according to the set parameters or to STOP a test before PASS or FAIL is signaled. Please refer to the preceding sections for more information on the SHORT, OCP & OPP tests.

System keys description

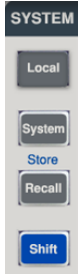

Shift key  Shift key is used to switch the key to the second function key.

System key  Press SYSTEM to set the argument, GPIB address, RS232 BAUD- RATE, WAKE UP and buzzer Alarm power ON/OFF and Master/Slave control.



Local key  Press Local key to exit REMOTE mode

Setting system parameters Set GPIB address, RS232 BAUD RATE, WAKE UP, Buzzer ON/OFF

Set GPIB
address

System

First press SYSTEM key, the LCD display shows GPIB on left 5 digit LCD display, Middle 5 digit LCD display Addr, right 5 digit LCD display setting GPIB address of the representative, Press UP, DOWN buttons to adjust the GPIB address 1~30, Key and then press ENTER, PEL-5000C series GPIB Address value is saved, Press system key four times to leave the GPIB address configuration State.

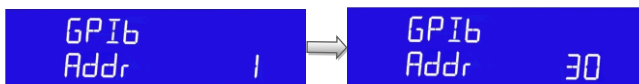

Set RS232
BAUD RATE

System

X2

SYSTEM key first by the second, the LCD display shows RS232 on left 5 digit LCD display, Middle 5 digit LCD display baud, right 5 digit LCD display setting BAUD-RATE, Press UP, DOWN buttons to adjust the value of BAUD RATE, Key and then press ENTER, PEL-5000C series is saved setting BAUD RATE, press system key three times to leave the BAUD-RATE setting state.

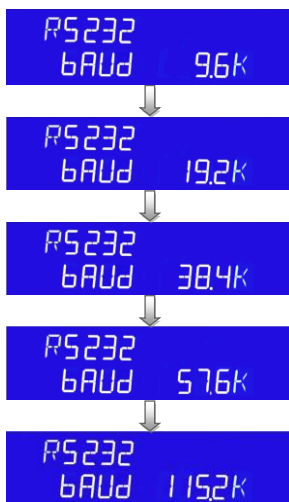

WAKE-UP
function

System

X3

This function is designed for auto setting the load status and load level in turning on the PEL-5000C series every time. SYSTEM key first by the three, The LCD display shows WAKE on left 5 digit LCD display, Middle 5 digit LCD display UP, right 5 digit LCD display setting, Press UP, DOWN buttons to adjust the 0~150.

Press ENTER key to be stored, press system key two times to leave the WAKE-UP setting state, If set to "0" means do not call.

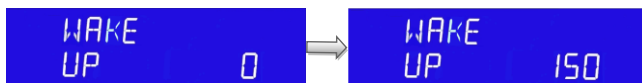

Buzzer ON/
OFF

System

X4

This is the test set automatically (AUTO SEQUENCE) at the end, if it increases buzzer function, if set to ON, Then when the test result is PASS automatically when the buzzer will call out, if the test result is FAIL when the buzzer will call the second tone.

Setting method:

first by 4 Times SYSTEM key and the LCD display shows SEQ on left 5 digit LCD display, Middle 5 digit LCD display BEEP, right 5 digit LCD display setting ON or OFF, press UP DOWN key to adjust.

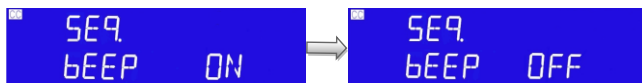

 Note

Setting system parameters, if the input is required to use the KEYPAD ENTER button to confirm, otherwise PEL-5000C Series will not save the changes the settings.

Pass: Automatic test mode, no NG state, is the PASS.

Fail: Automatic test mode, any test if the NG then is the FAIL.

Recall/ Store
key

Store

Recall

Recall/ Store load state settings

The function keys on the front panel of PEL-5000C series mainframe are designed for high testing throughput purpose. There are 150 operation states or testing steps can be store in the EEPROM memory of PEL-5000C series electronic load respectively, each state can store or recall the load status and level for electronic load simultaneously.

STORE
process

Store

Recall

- Set the load status and load level.
- Press SHIFT key then press the STORE key to enter the storage state.
- Press UP, DOWN key or KEYPAD to adjust, press the ENTER OK to save the STATE.

RECALL
operation

Store

Recall

- Press RECALL to enter the call state.
- Press UP, DOWN key or KEYPAD to adjust.
- Finally, Press the ENTER key to confirm, in the electronic load front panel, set the value that would call out the information in accordance with re-setting.

AUTO
SEQUENCE
instructions

PEL-5000C series has AUTO SEQUENCE function, PEL-5000C series to select the state F1~F9 Automatic testing can be edited, 16 steps each group can be set to select 150 group of the STATE, within each step can be set TEST TIME Units of 100 ms range (0.1s ~ 9.9s).

Edit mode



Press SHIFT key, press the SEQ. key to enter the AUTO SEQUENCE mode, Press UP, DOWN key to select EDIT, the LCD display shows EDIT on left 5 digit LCD display, Middle 5 digit LCD display FX, "FX" means to Select the state F1-F9, Press keypad key 1 ~ 9 choose F1 ~ F9.

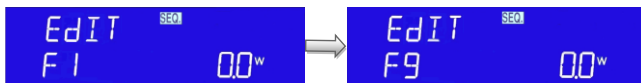

- Press ENTER key, the LCD display shows FX-XX on left 5 digit LCD display, Middle 5 digit LCD display STATE, right 5 digit LCD display setting 1~150, "FX" means to select the state F1-F9. "XX" means the test STEP01-16, setting state value, press UP and down key or keypad to adjust setting.

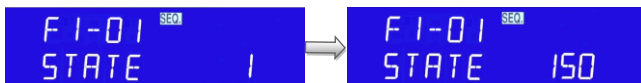

Test time setting

- Press ENTER to set TIME value, press UP, DOWN keys or KEYPAD to adjust settings, range from 100 ms~9999ms. Press ENTER key or SAVE key to finish editing the action is set to repeat, if you do not save the settings, press the EXIT key to leave edit mode.

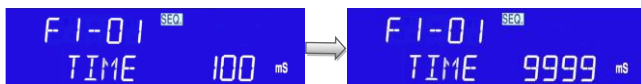

- Setting repeat (REPEAT TEST) ,Press UP and DOWN key or Keypad to adjust setting 0~9999, Press ENTER SAVE REPEAT Value, or press EXIT key Exit EDIT MODE.

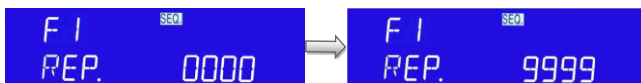

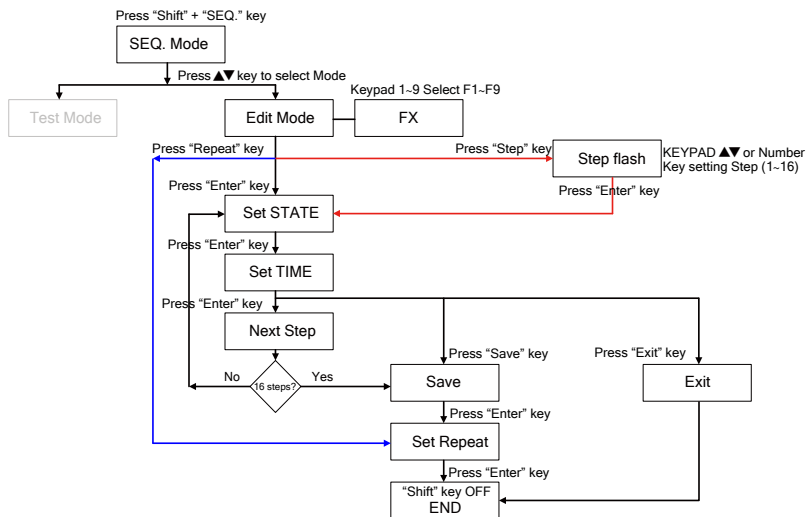

Store (Edit) mode operation flow chart

Test mode

- Press **SHIFT** key, press the **SEQ.** key to enter the **AUTO SEQUENCE** mode, Press **UP**, **DOWN** key to select **TEST**, the LCD display shows **tEST** on left 5 digit LCD display, Middle 5 digit LCD display **FX**, "FX" means to Select the state **F1-F9**, Press keypad key **1 ~ 9** choose **F1 ~ F9**. When the press **ENTER** to enter. The next automatic test Mode.
- Test LCD will display "SXX", "XX" on behalf of the test of **STEP**, if the test result is **NG**, the LCD will show "NG" (flashing) and suspension of the test, this time users can test or **ENTER** key to continue Press **EXIT** key to leave the test mode, test mode by the (STEP01 - TIME) then (SETP02 - TIME) until all the steps done or press **EXIT** to leave the test mode.

- If all the test steps are OK, the test result is PASS, LCD displays "PASS"; test procedure if any of the NG, the test result is FAIL,, LCD displays "FAIL", if the buzzer is set to ON, when the test result is pass automatically when the buzzer will call out, if the test result is fail Buzzer will sound when the second call.

When the test is completed, the user can press the ENTER key again to test or EXIT key to leave the test mode.

Example

Edit the 16 step test is completed, press the TEST key, according to the order of S01 ~ S16 test is complete LCD display PASS.

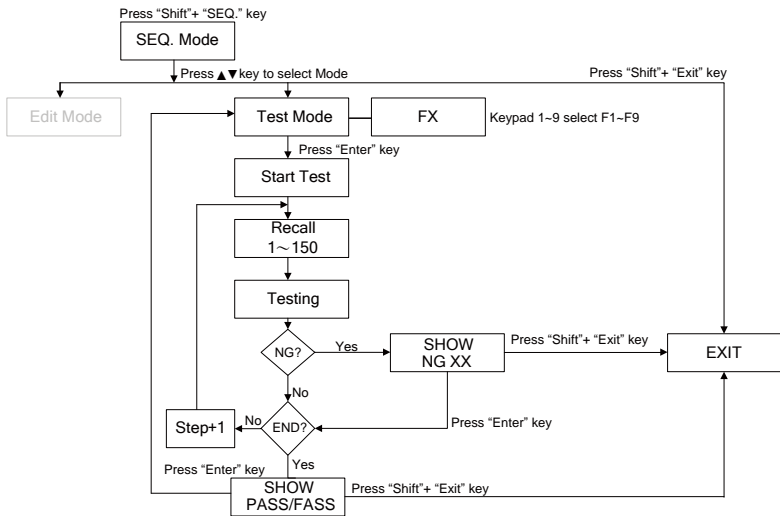

Test mode operation flow chart

Test keys description



Rotary Knob The ROTARY knob and ARROW keys are used to increase or decrease the set values.
Keys

- Clockwise the rotary switch and up arrow key to increase the setting values.

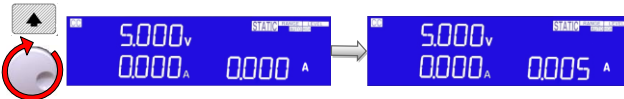

- Anti-clockwise and down arrow key operation of the ROTARY Knob decreases the setting value.

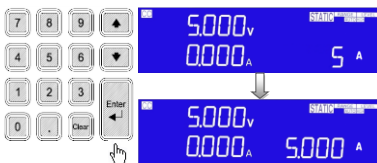

- Keypad key: When using the Keypad, please enter the number, press the Enter key.

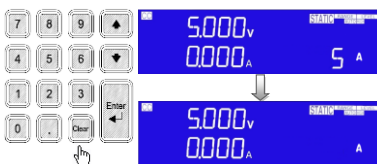

- Clear KEY: Setting, press the Clear key to clear the input value.



In CR mode, the up arrow key and clockwise operation of the rotary Knob reduces the resistance.

In CR mode, the down arrow key & anti-clockwise operation of the rotary Knob increases the resistance.

C CONNECTION

Rear Panel	77
Connecting the I-monitor to an oscilloscope	80
Master/Slave Instructions.....	82

Rear Panel

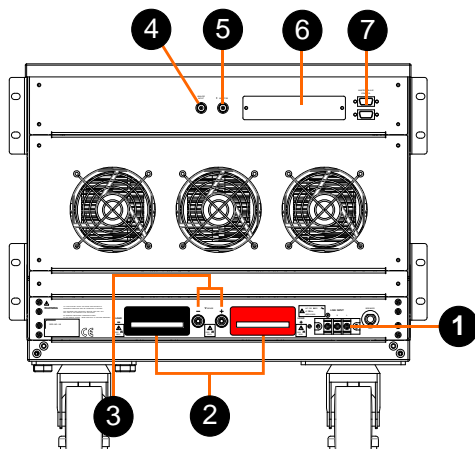

1 AC Line INPUT

- 2 INPUT Terminal The positive (LOAD +) and negative (LOAD -) power input terminals are clearly marked. DO NOT confuse them with the smaller SENSE terminals.

Please ensure that the voltage and current rating of the DUT do not exceed the maximum rating of the PEL-5000C Series load module being used. Please also check the output polarity of the DUT prior to connection and testing.

The negative load terminal should be connected to ground if testing a positive output power supply. This is normally achieved when the negative output of the power supply is grounded.

Similarly if a power supply with a negative output is to be tested then the positive load terminal should be grounded. This is normally achieved when the positive output of the power supply under test is grounded.

3 V-sense input terminal

The V-sense terminals can be used to compensate for a voltage drop in the load lines between the power supply and the PEL-5000C series Electronic Load. This is a useful feature useful when the load current is relatively high.

If remote sense is required the V-sense terminals are connected to the appropriate positive and negative terminals of the power supply as shown in fig below. In the CONFIG menu the V-sense function can be set to AUTO or ON.

Please note that if V-sense is set to AUTO and the sense leads are connected to the DUT the losses need to be approx. before the display compensates for the voltage loss.

If V-sense is set to 'ON' and the sense terminals are connected to the DUT the load will check and compensate for all voltage drops.

The maximum voltage sense compensation is the same as the rating of the PEL-5000C series electronic load. For example the PEL-5006C-1200-240 is capable of sinking current at up to 1200Vdc. Therefore the maximum V-sense is also 1200Vdc.

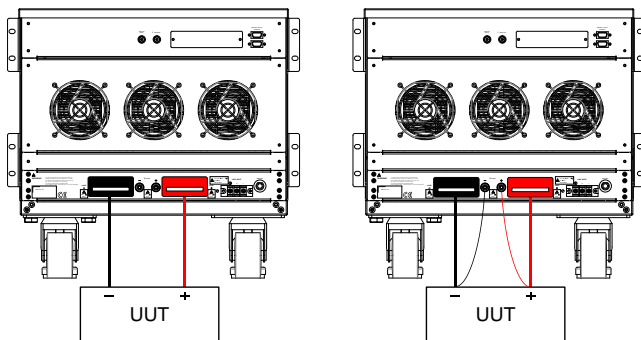

Typical connection of PEL-5000C series load module

4 Analog programming input

The Electronic Load has an analog programming input on the rear panel of the mainframe. The analogue programming input enables the load module to track and load according to an external 0-10V (ac or ac + dc) signal.

The analog programming input is configured as a BNC socket on the mainframe's rear panel.

The analogue programming input operates in CC or CP modes only. The PEL-5000C series Load will attempt to load proportionally according to the signal and the load module's maximum current or power range. For example: PEL-5012C-600-840: $I_{max} = 840A$ and $P_{max} = 12000W$

So in CC mode if analogue programming input is 5V = 420A load setting (Range II) or in CP mode if analogue programming input is 1V = 1200W load setting (Range II)

The analog programming signal can act alone or it can be summed with the programmed value set via the front panel or the optional computer interface (GPIB, RS-232, USB, or LAN) or the front panel.

Example

The fig. below shows the result of an analog programming signal at 4 Vac, 500Hz when it is summed with a 128A programmed setting in CC mode of PEL-5012C-600-840 Load.

Analog programming example

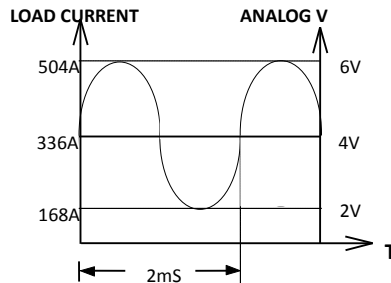

- 5 I-monitor The I-monitor is provided as a BNC socket. It is designed to enable the user to monitor the Electronic Load's input current or short current. The I-monitor's signal is 0V to 10V. This signal is proportional to the full scale current that the particular electronic Load is capable of.

Example PEL-5012C-600-840: $I_{max} = 840A$ therefore I-monitor 10V = 840A so 1V = 84A

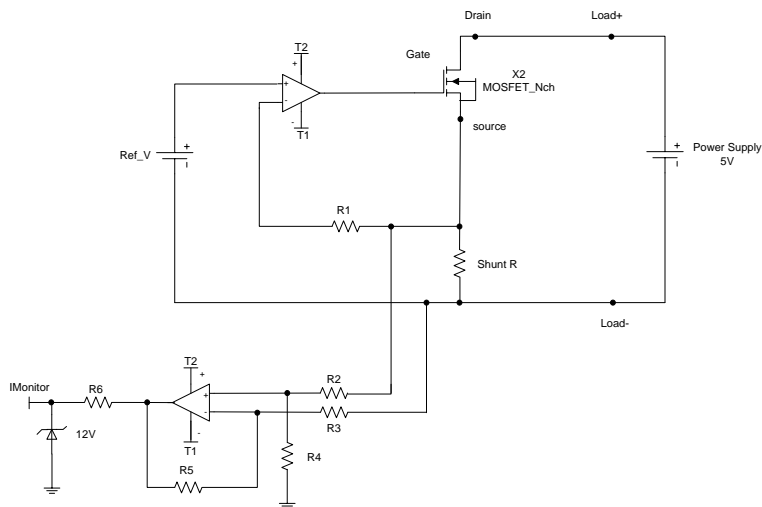

An equivalent circuit in terms of the current monitor

Connecting the I-monitor to an oscilloscope

When you connect this product to an oscilloscope, please ensure the correct polarities of the connecting probes as shown in fig below

(Correct)
Connections to
an oscilloscope

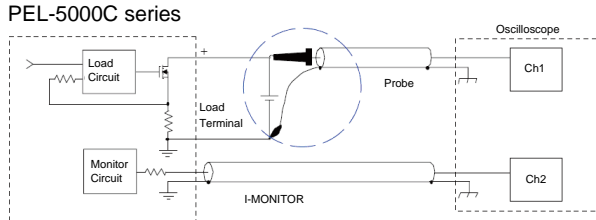

(Wrong)
Connections to
an oscilloscope

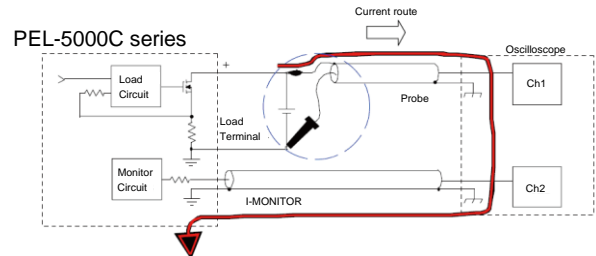

If the probes connection is reversed as shown above, a large current would flow through the probe and the internal circuitry of the oscilloscope is likely to be damaged.

Master/Slave Instructions

PEL-5000C Series "MASTER / SLAVE" Parallel function, 1 Master, 7 SLAVE, setting method press the System key to set the CONTROL MODE to select ALONE, MASTER or SLAVE1 ~ 7, Press the ENTER key to set, when Power off Data will not be lost, this parameter is saved. Master will automatically detect whether there is slave machine, if there is no Slave Machine will run "ALONE Mode", if the Slave machine will run "MASTER Mode". Master machine measuring current and power meter is to show the total current and total power (Master + Slave), the voltage meter is displayed by the Master Machine, the Slave machine voltage meter position will display "SL1" ~ "SL7".

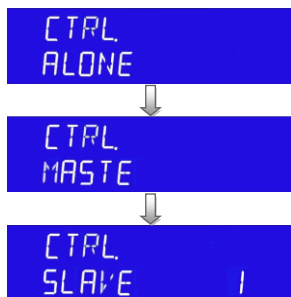

The following procedure should be followed before applying power on Master/Slave mains:
Step1. Turn on (O) the Slave POWER switch.
Step2. Turn on (O) the Master POWER switch.

The following procedure should be followed before applying power off

Master/Slave mains:

Step1. Turn off (I) the Master POWER switch.
Step2. Turn off (I) the Slave POWER switch.

Parallel method Use HD-DSUB 15pin 1: 1 Cable to connect the MASTER and SLAVE rear panel, HD-DSUB 15pin connector (connect the upper and lower Connectors)

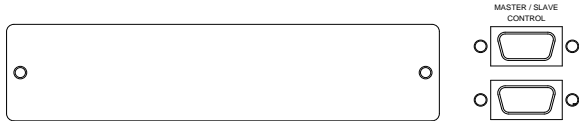

 **Caution** Do not use VGA Cable, because of internal pin4 ~ 8, 11 and chassis short circuit.

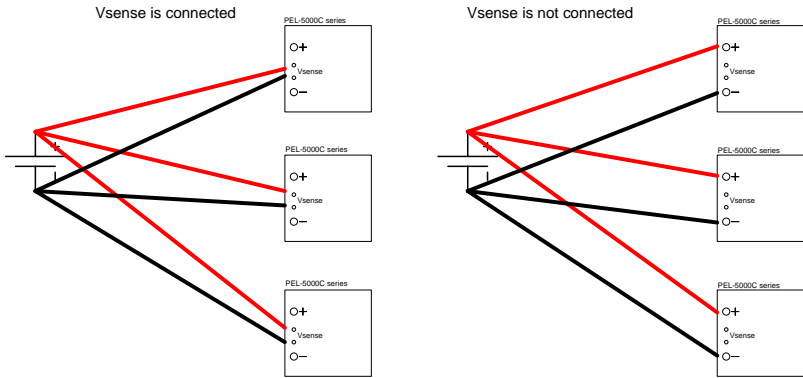

Wiring requirements Master/Slave, It requires wiring as follows:



Manual operation (PEL-5012C-600-840 MASTER/SLAVE model the following is example)PRESET setting:
 CC/CR/CV/CP Mode as Figure , CC setting
 64A=Master 32A + Slave 32A ,
 CR:12500Ω=Master//Slave=6250Ω//6250Ω, CV:
 100V=Master 100V=Slave=100V ,
 CP:1000W=Master 500W + Slave 500W.

CC Set 100A	Master Display	
	Slave Display	

CR Set 12500Ω	Master Display	
	Slave Display	
CP Set 1000W	Master Display	
	Slave Display	
CV Set 100V	Master Display	
	Slave Display	



Note

Master Mode operation except CC / CR / CV / CP Mode, The following functions will be disabled.

- Config function BATT type 1~N Disable
- Config functions MPPT disable.
- CC+CV, CP+CV Disable.
- Recall/Store Disable.
- Auto Seq. Disable.
- Short, OCP, OPP Disable.
- External I/O Disable

INSTALLATION

Check line voltage.....	86
Grounding requirements	86
Power up	87
Connection to the load Input Terminal	87
GPIB & RS232 interface option	88
RS232 interface option	89
GPIB interface option	89
USB interface option	90
LAN interface option	90
I/O connection	91
Load current slew rate setting	92
Load wire inductance.....	94

Check line voltage

Background The PEL-5000C Series high power load can operation with 100 Vac ~240Vac input as indicated on the label on the rear panel. Make sure that the factory check mark corresponds to your nominal line voltage. Skip this procedure if the label is corrected marked.

- Installation**
1. With the PEL-5000C series load power OFF, disconnect the power cord.
 2. Refer the drawing on the rear panel of PEL-5000C Series high power load below.
-

PEL-5000C series
AC Input
Connection

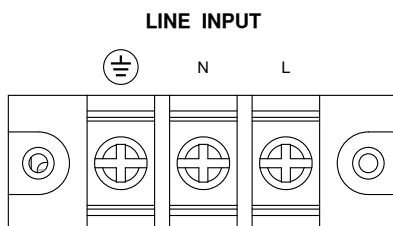

Grounding requirements

- Installation**
1. It is requested to use the 3Pin plug connector only for PEL-5000C Series mainframe to out of danger when electric leakage. And the complete and proper grounded is necessary.
 2. The PEL-5000C Series high power load is equipped with three conductor cable which plugs in an appropriate receptacle to ground the instrument's cover.
-

Power up

- | | |
|-----------|--|
| Procedure | <ol style="list-style-type: none">1. Turn off (O) the POWER switch.2. Check that the power cord is corrected.3. Check that nothing is connected to the DC INPUT on the rear panels.4. Turn on POWER switch. |
|-----------|--|
-

Connection to the load Input Terminal

Connection procedure of the load input terminal on the rear panel

- | | |
|-----------|---|
| Procedure | <ol style="list-style-type: none">1. Turn off POWER switch.2. Check that the output of the equipment under test is off.3. Connect the load wire to the load input terminal on the rear panel.4. Check the polarity of the connection and connect the load wire to the output terminal of the equipment under test. |
|-----------|---|
-



Avoid equipment damaged, don't input the DC voltage standard output to the DC Load input terminal, if calibration voltage meter required, please input the DC voltage standard to the Vsense input.

GPIB & RS232 interface option

Connection procedure of the load input terminal on the rear panel

Procedure

1. GPIB + RS232 interface is on the rear panel of PEL-5000C Series Mainframe for application GPIB or RS232.
2. GPIB and RS232 interface can only be used at the same time, to change the interface must reboot unit.
3. GPIB connection with three important limitations as described below:

The maximum number of devices including the controller is no more than 15.

The maximum length of all cable is no more than 2 meters times the number of devices connected together, up to 20 meters Maximum.

RS232 female block connections on the back panel, the connecting device and the computer RS232 port to one-way connection.

The figure below shows the RS232 connector (Female) on the rear panel connects PEL-5000C Series Mainframe to RS232 port of computer in one by one configuration .The RS232 BAUD-RATE can be set in the front panel, it will be lit the GPIB address when press the "SYSTEM" button. Press it again, it will be lit the BAUD-RATE.

PEL-5000C series
GPIB & RS232
interface



RS232 interface option

Connection procedure of the load input terminal on the rear panel

The figure below shows the RS232 connector (Female) on the rear panel connects PEL-5000C Series mainframe to RS232 port of computer in one by one configuration. The RS232 BAUD-RATE can be set in the front panel, it will be lit the GPIB address when press the "SYSTEM" button. Press it again, it will be lit the BAUD-RATE.

PEL-5000C series
RS232 interface



GPIB interface option

Connection procedure of the load input terminal on the rear panel

The maximum number of devices including the controller is no more than 15.

The maximum length of all cable is no more than 2 meters times the Number of devices connected together, up to 20 meters maximum.

PEL-5000C Series
GPIB interface

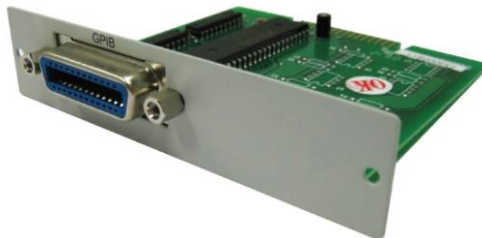

USB interface option

Connection procedure of the load input terminal on the rear panel

The figure below shows the USB connector in the rear panel of PEL-5000C series mainframe.

PEL-5000C USB interface



LAN interface option

Connection procedure of the load input terminal on the rear panel

The figure below shows the LAN connector in the rear panel of PEL-5000C series mainframe.

PEL-5000C LAN interface



I/O connection

Connection procedure of the load input terminal on the rear panel

PEL-5000C series I/O Interface with V_{sense},
Analog Programming Input, I_{monitor}

PEL-5000C series
I/O interface

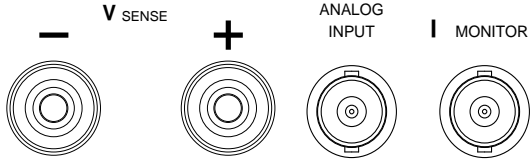

Load current slew rate setting

Connection procedure of the load input terminal on the rear panel

What is the load current slew rate during load current level change, power supply turn ON/OFF switch between ON, and OFF? The PEL-5000C series Electronic load provides all of the above load current slew rate in controllable condition, the rise and fall current slew rate can be set independently from front panel operation or remote programming.

The slew rate determines a rate at which the current changes to a new programmed value. The slew rate can be set at the front panel or via GPIB on the rear panel of PEL-5000C series high power load.

The rise and fall slew rate can be independently programmed from 384mA/usec to 24A/usec (PEL-5012C-600-840 Load) in the 840A current range and from 38.4mA/usec to 2.4A/usec in the 84A current range. This allows a independent controlled transition from Low load current level to High load current level (Rise current slew rate) or from High load current level to Low load current level(Fall current slew rate) to minimize induced voltage drops on the inductive wiring, or to control induced transients on the est. device (power supply transient response testing).

This controllable load current slew rate feature also can eliminate the overload current Phenomenon and emulate the actual load current slew rate at turn ON the power supply Under test. The load current slew rate is according to the power supply's Output Voltage, Load level setting and Load ON/OFF switch. So, you could do all items of Power

Supply testing task by using constant current mode only, it can significantly improve The Testing quality and Process as well as efficiency.

There are two load current range in PEL-5000C series Load, Range I and Range II, the slew rate of range I, range II, RISE/FALL slew rate are listed in paragraph specifications.

The relationship of load current load ON/OFF, load level and output voltage of DC power supply at turn ON

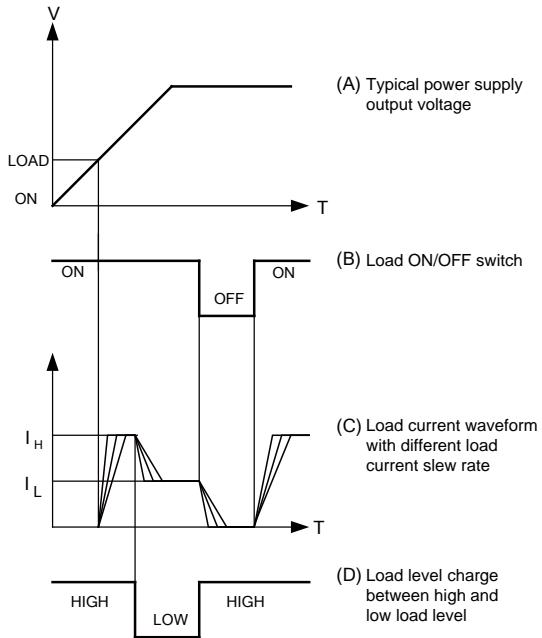

Load wire inductance

Connection procedure of the load input terminal on the rear panel

The load wiring has an inductance (L). When the current (I) varies in short time period, It generates a large voltage at both ends of the wiring cable. This voltage applies to all of the load input terminals of the PEL-5000C series when the impedance of the EUT is relatively small. The voltage generated by the load wire inductance (L) and the current variation (I) is expressed using the following equation.

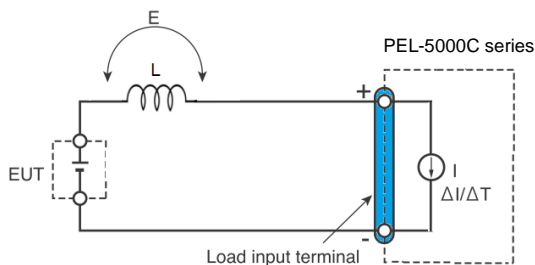

$$E = L \times (\Delta I / \Delta T)$$

E: Voltage generated by the wire inductance

L: Load wire inductance

ΔI : Amount of Current variation

ΔT : Variation period of current

In general, the wire inductance can be measured approximately $1 \mu\text{H}$ per 1 meter. If the 10 meters of Load wires is connected between the EUT and the electronic load (PEL-5000C Series) with the current Variation of $2 \text{ A}/\mu\text{s}$, the voltage generated by the wire inductance Will be 20 V.

The negative polarity of the load input terminal is the reference potential of the external Control signal, Therefore, the device connected to the external control terminal may get malfunctioned.

When operating under the constant voltage (CV) mode or constant resistance (CR) mode or constant power (CP), the load current is varied by the voltage at the load input terminal, so the operation can be affected easily by the generated voltage.

The wiring to the EUT should be twisted and the shortest as possible.

If the load wire is long or has a large loop, the wire inductance is increased. Consequently, the Current variation that results when switching occurs will cause a large voltage drop.

When the value of instantaneous voltage drops under the minimum operating voltage depends on the generated voltage at the load input terminal, the response of recovery will be extensively delayed.

In such event, the electronic load may generate unstable oscillation. In such condition, the input voltage may exceed the maximum input voltage and Cause damage to the PEL-5000C Series.

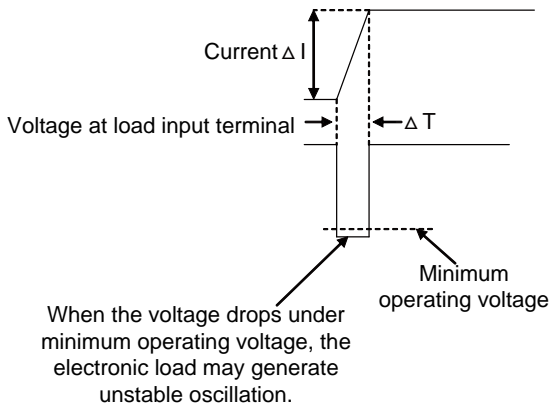

Waveform example:
Generate unstable oscillation

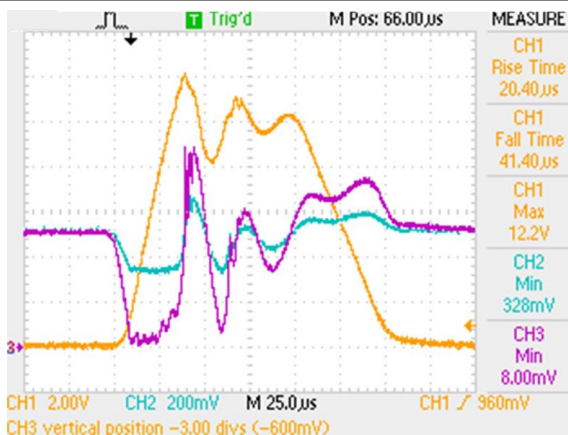

CH1= Imonitor

CH2=Power Supply output Voltage (x10)

CH3= LOAD Input Voltage (x10)

You must be careful especially when the slew rate setting is high or switching is performed using large currents through parallel operation.

To prevent problems, connect the PEL-5000C Series and the equipment under test using the shortest Twisted Wire possible to keep the voltage caused by inductance between the minimum operating Voltage and the maximum input voltage range or set a low slew rate.

If the high-speed response operation is not required, decrease the slew rate setting.

In such settings, the value of DI / DT will be decreased, accordingly the generated voltage Will be reduced even the inductance of load wiring can't be reduced.

In the case of DC operation also, the phase delay of the current may cause instability in the PEL-5000C Series Control inducing oscillation. In this case also, connect the PEL-5000C Series and the equipment under test using the shortest twisted wire possible.

If only DC operation is required, a capacitor may be connected to the load Input Terminal as shown in Fig below to alleviate oscillation. In this case, use the capacitor within its allowable ripple current.

Length of wiring

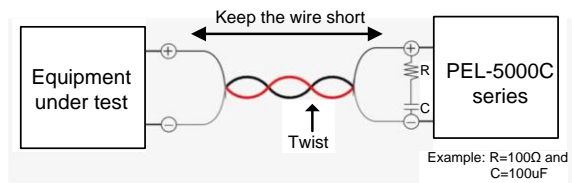

REMOTE CONTROL

The rear panel remote control interface of PEL-5000C Series mainframe is designed to connect PC or NOTEBOOK PC with remote control interface, the NOTEBOOK PC acts as a remote controller of PEL-5000C Series Electronic Load.

This feature can be used as an automatic load/cross load regulation and centering voltage testing for a switching power supply or an rechargeable battery charge/discharge characteristic testing. The function capability of rear panel remote control interface not only can set the load level and load status, but also can read back the load voltage and load current.

Interface Configuration	99
Configure RS232C	99
Communication Interface programming	
command list.....	101
SIMPLE TYPE FORMAT	101
System command.....	105
Measure command	105
AUTO SEQUENCE.....	106
COMPLEX TYPE FORMAT	106
Command Syntax	112
The description of abbreviation	112
Communication Interface programming command syntax	
description	112
Command List	114

Interface Configuration

The rear panel Communication Interface programming of PEL-5000C series mainframe is designed to connect PC or NOTEBOOK PC with remote control interface, the NOTEBOOK PC acts as a Communication Interface programming of PEL-5000C series Electronic Load.

This feature can be used as an automatic load/cross load regulation and centering voltage testing for a switching power supply or a rechargeable battery charge/discharge characteristic testing. The function capability of rear panel communication Interface programming not only can set the load level and load status, but also can read back the load voltage and load current.



Note

When use USB/LAN interface controls the PEL-5000C series, the PEL-5000C series will convert the USB/LAN interface to RS232 interface.

Configure RS232C

The following RS232 commands are same as GPIB commands. The RS232 protocol in PEL-5000C Series mainframe is listing below:

RS232C Configuration	Baud Rate	9600~115200bps
	Stop Bit	1 bit
	Data Bit	8 bits
	Parity	None
	Handshaking	Hardware (RTS/CTS)

The RS232 Interface connector of PEL-5000C Series rear panel

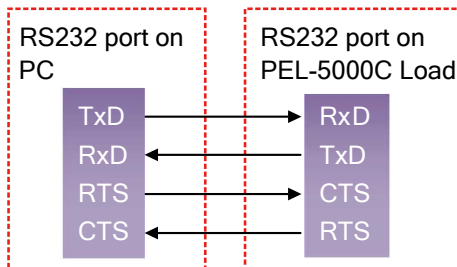

Inside of PEL-5000C series Mainframe

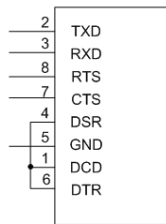

Pin Assignment

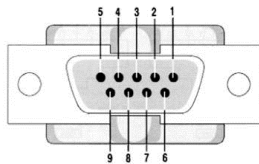

PIN	Abbreviation	Description
Pin1	CD	Carrier Detect
Pin2	RXD	Receive
Pin3	TXD	Transmit
Pin4	DTR	Data Terminal Ready
Pin5	GND	Ground
Pin6	DSR	Data Set Ready
Pin7	RTS	Request To Send
Pin8	CTS	Clear To Send
Pin9	RI	Ring Indicator

Communication Interface programming command list

SIMPLE TYPE FORMAT

Table: Communication interface programming setting command summary

SETTING PRESET NUMERIC COMMAND	REMARK
RISE{SP}{NR2}{; NL}	A/us
FALL{SP}{; NL}	A/us
PERD:{HIGH LOW}{SP}{NR2}{; NL}	
LDONV{SP}{NR2}{; NL}	
LDOFFV{SP}{NR2}{; NL}	
CC CURR:{HIGH LOW}{SP}{NR2}{; NL}	
CP:{HIGH LOW}{SP}{NR2}{; NL}	
CR RES:{HIGH LOW}{SP}{NR2}{; NL}	
CV VOLT:{HIGH LOW}{SP}{NR2}{; NL}	
TCONFIG{SP}{NORMAL OCP OPP SHORT}{; NL}	
OCP:START{SP}{NR2}{; NL}	
OCP:STEP{SP}{NR2}{; NL}	
OCP:STOP{SP}{NR2}{; NL}	
VTH{SP}{NR2}{; NL}	
OPP:START{SP}{NR2}{; NL}	
OPP:STEP{SP}{NR2}{; NL}	
OPP:STOP{SP}{NR2}{; NL}	
STIME{SP}{NR2}{; NL}	
MPPT{SP}{ON OFF}{; NL}	
MPPTIME{SP}{n}{; NL}	SET MPPT RECORD TIME, n=1000~60000 ms
BATT:TYPE{SP}{n}{; NL}	n=1~5
BATT:UVP{SP}{NR2}{; NL}	unit:V
BATT:CURR{SP}{NR2}{; NL}	CC CURR:HIGH{SP}{NR2}{; NL}
BATT:POWER{SP}{NR2}{; NL}	CP:HIGH{SP}{NR2}{; NL}

BATT:TIME{SP}{n}{; NL}	0~99999 ,0=OFF
BATT:AH{SP}{NR2}{NL}	0,0.1~19999.9 ,0=OFF
BATT:WH{SP}{NR2}{NL}	0,0.1~19999.9 ,0=OFF
BATT:TEST{SP}{ON OFF}	TEST ON/OFF
BATT:STEP{SP}{n}{; NL}	Cycle Life TEST: n=1~3,TYPE5:n=1~9
BATT:CCH{n}{SP}{NR2}{; NL}	Cycle Life TEST CC:HIGH level, n=1~3
BATT:CCL{n}{SP}{NR2}{; NL}	Cycle Life TEST CC:LOW level, n=1~3
BATT:TH{n}{SP}{NR2}{; NL}	Cycle Life TEST Thigh (unit:ms), n=1~3
BATT:TL{n}{SP}{NR2}{; NL}	Cycle Life TEST Tlow (unit:ms), n=1~3
BATT:CYCLE{n}{SP}{NR1}{; NL}	Cycle Life TEST:1~2000, n=1~3
BATT:DYN{SP}{ON OFF}	Cycle Life TEST ON/OFF
BATT:CC{n}{SP}{NR2}{; NL}	RAMP Current, n=0~9
BATT:CV{n}{SP}{NR2}{; NL}	RAMP Voltage, n=0~9
BATT:DTIME{n}{SP}{NR1}{; NL}	TYPE5 Delta time (T1~T9:0~6000sec), n=0~9
BATT:REPEAT{n}{SP}{; NL}	Disch CC/CP Repeat times:0~9999
BATT:RAMP:CC{SP}{ON OFF}	RAMP CC TEST ON/OFF
BATT:RAMP:CV{SP}{ON OFF}	RAMP CV TEST ON/OFF
SURGE: SURI{NR2}{; NL}	
SURGE: NORI{NR2}{; NL}	
SURGE: TIME{NR2}{; NL}	SURGE TIME:10~1000ms
SURGE: STEP{SP}{n}{; NL}	n=1~5
SURGE {ON OFF}{; NL}	ON:RUN SURGE, OFF:STOP
CPRSP{SP}{n}{; NL}	n=0~4
AVG{SP}{n}{; NL}	
FAN{SP}{n}{; NL}	n=1~3

Table: Communication Interface programming query command summary

QUERY PRESET NUMERIC COMMAND	RETURN
RISE{?}; NL}	###.####
FALL{?}; NL}	###.####
PERD:{HIGH LOW}{?}; NL}	###.####
LDONV{?}; NL}	###.####
LDOFFV{?}; NL}	###.####
CC CURR:{HIGH LOW}{?}; NL}	###.####
CP:{HIGH LOW}{?}; NL}	###.####
CR RES:{HIGH LOW}{?}; NL}	###.####
CV VOLT:{HIGH LOW}{?}; NL}	###.####
TCONFIG{?}; NL}	1:NORMAL 3:OPP 2:OCP 4:SHORT
OCP: START{?}; NL}	###.####
OCP: STEP{?}; NL}	###.####
OCP: STOP{?}; NL}	###.####
VTH{?}; NL}	###.####
OPP: START{?}; NL}	###.####
OPP: STEP{?}; NL}	###.####
OPP: STOP{?}; NL}	###.####
STIME{?}; NL}	###.####
OCP{?}	###.####
OPP{?}	###.####
MPP{?}; NL}	READ MPP DATA "V/I/P" OR "END"
MPPTIME{?}; NL}	#####
BATT:RAH{?}; NL}	READ BATT TEST RESULT AH
BATT:RWH{?}; NL}	READ BATT TEST RESULT WH
BATT:RTIME{?}; NL}	READ BATT TEST RESULT TIME
BATT:RVOLT{?}; NL}	READ BATT TEST RESULT VOLTAGE
AVG{?}; NL}	
FAN{?}; NL}	

Table: Communication Interface programming limit command summary

LIMIT COMMAND	REMARK
IH IL{SP}{NR2}{; NL}	
IH IL{?}{; NL}	
WH WL{SP}{NR2}{; NL}	
WH WL{?}{; NL}	###.####
VH VL{SP}{NR2}{; NL}	
VH VL{?}{; NL}	###.####
SVH SVL{SP}{NR2}{; NL}	
SVH SVL{?}{; NL}	###.####
[LIMit :]ADDCV:VOLTage{SP}{NR2}{; NL}	
[LIMit :]ADDCV:VOLTage{?}{; NL}	###.####
[LIMit :]ADDCV{SP}{ON OFF}{; NL}	

Table: STAGE COMMAND SUMMARY

STAGE COMMAND	REMARK
LOAD{SP}{ON OFF 1 0}{; NL}	
LOAD{?}{; NL}	0:OFF 1:ON
MODE{SP}{CC CR CV CP}{; NL}	
MODE{?}{; NL}	0:CC, 1:CR, 2:CV, 3:CP
SHOR{SP}{ON OFF 1 0}{; NL}	
SHOR{?}{; NL}	0:OFF 1:ON
PRES{SP}{ON OFF 1 0}{; NL}	
PRES{?}{; NL}	0:OFF 1:ON
SENSe{SP}{ON OFF AUTO 1 0}{; NL}	
SENSe{?}{; NL}	0:OFF/AUTO, 1:ON
LEV{SP}{LOW HIGH 0 1}{; NL}	
LEV{?}{; NL}	0:LOW, 1:HIGH
DYN{SP}{ON OFF 1 0}{; NL}	
DYN{?}{; NL}	0:OFF 1:ON
CLR{; NL}	
ERR{?}{; NL}	
NG{?}{; NL}	0:GO 1:NG
PROT{?}{; NL}	
CC{SP}{AUTO R2}{; NL}	
NGENABLE{SP}{ON OFF}{; NL}	

POLAR{SP}{POS NEG}{; NL}	
START{; NL}	
STOP{; NL}	
TESTING{?}{; NL}	0:TEST END,1:TESTING
	ON:START TEST, OFF:STOP TEST
	TYPE 1 & 2 TEST END, AUTO ECHO
BATT:TEST{SP}{ON OFF}{; NL}	“OK,XXXXX” XXXXX:AH TYPE 3~5 TEST END, AUTO ECHO “OK,XXXXX” XXXXX:DVM

System command

Table: SYSTEM COMMAND SUMMARY

COMMAND	NOTE	RETURN
RECALL{SP}{m}{; NL}	m=1~150, m:STATE	
STORE{SP}{m}{; NL}	m=1~150 m:STATE	
REMOTE{; NL}	RS232/USB/LAN command	
LOCAL{; NL}	RS232/USB/LAN command	
NAME{?}{; NL}		“XXXXX”

Measure command

Table: MEASURE COMMAND SUMMARY

COMMAND	RETURN
MEAS: CURR{?}{; NL}	###.####
MEAS: VOLT{?}{; NL}	###.####
MEAS: POW{?}{; NL}	###.####
MEAS: VC{?}{; NL}	###.####,###.####

- Remark
1. Current engineering unit: A
 2. Voltage engineering unit: V
 3. Resistance engineering unit: Ω
 4. Period engineering unit: mS
 5. Slew-rate engineering unit: A/μS

6. Power engineering unit: W

AUTO SEQUENCE

Table: Auto sequence command list

AUTO SEQUENCE SET COMMAND	NOTE	RETURN
FILE{SP}{n}{; NL}	n=1~9	1~9
STEP{SP}{n}{; NL}	n=1~16	1~16
TOTSTEP{SP}{n}{; NL}	Total step n=1~16	1~16
SB{SP}{n}{; NL}	m=1~150 m:STATE	
TIME{SP}{NR2}{; NL}	100~9999(ms)	100~9999(ms)
SAVE{; NL}	Save "File n" data	
REPEAT{SP}{n}{; NL}	n=0~9999	0~9999
RUN{SP}{F}{n}{; NL}	n=1~9	AUTO REPLY "PASS" or "FAIL:XX" (XX=NG STEP)

COMPLEX TYPE FORMAT

Table: Communication Interface programming setting command summary

SETTING COMMAND SUMMARY	REMARK
[PRESet:]RISE{SP}{NR2}{; NL}	A/us
[PRESet:]FALL{SP}{; NL}	A/us
[PRESet:]PERI PERD:HIGH LOW{SP}{NR2}{; NL}	
[PRESet:] LDONv{SP}{NR2}{; NL}	
[PRESet:] LDOFv{SP}{NR2}{; NL}	
[PRESet:]CC CURR{HIGH LOW}{SP}{NR2}{; NL}	
[PRESet:]CP:{HIGH LOW}{SP}{NR2}{; NL}	
[PRESet:]CR RES:{HIGH LOW}{SP}{NR2}{; NL}	
[PRESet:]CV VOLT: {HIGH LOW}{SP}{NR2}{; NL}	
[PRESet:]TCONFIG{SP}{NORMAL OCP OPP SH ORT}{; NL}	
[PRESet:]OCP:START{SP}{NR2}{; NL}	
[PRESet:]OCP:STEP{SP}{NR2}{; NL}	
[PRESet:]OCP:STOP{SP}{NR2}{; NL}	

[PRESet:]VTH{SP}{NR2}{;} NL}	
[PRESet:]OPP:START{SP}{NR2}{;} NL}	
[PRESet:]OPP:STEP{SP}{NR2}{;} NL}	
[PRESet:]OPP:STOP{SP}{NR2}{;} NL}	
[PRESet:]STIME{SP}{NR2}{;} NL}	
[PRESet:]MPPTIME{SP}{n}{;} NL}	SET MPPT RECORD TIME n=1000~60000 mS
[PRESet:]BATT:TYPE{SP}{n}{;} NL}	n=1~5
[PRESet:]BATT:UVP{SP}{NR2}{;} NL}	unit:V
[PRESet:]BATT:CURR{SP}{NR2}{;} NL}	=CC CURR:HIGH {SP}{NR2}{;} NL}
[PRESet:]BATT:POWER{SP}{n}{;} NL}	=CP:HIGH{SP}{NR2} {;} NL}
[PRESet:]BATT:TIME{SP}{n}{;} NL}	0~99999, 0=OFF
[PRESet:]BATT:AH{SP}{n}{;} NL}	0,0.1~19999.9, 0=OFF
[PRESet:]BATT:WH{SP}{n}{;} NL}	0,0.1~19999.9, 0=OFF
[PRESet:]BATT:TEST{SP}{ON OFF}	TEST ON/OFF
[PRESet:]BATT:STEP{SP}{n}{;} NL}	Cycle Life TEST: n=1~3, TYPE5:n=1~9
[PRESet:]BATT:CCH{n}{SP}{NR2}{;} NL}	Cycle Life TEST CC:HIGH level, n=1~3
[PRESet:]BATT:CCL{n}{SP}{NR2}{;} NL}	Cycle Life TEST CC:LOW level, n=1~3
[PRESet:]BATT:TH{n}{SP}{NR2}{;} NL}	Cycle Life TEST Thigh(unit:ms), n=1~3
[PRESet:]BATT:TL{n}{SP}{NR2}{;} NL}	Cycle Life TEST Tlow (unit:ms), n=1~3
[PRESet:]BATT:CYCLE{n}{SP}{NR1}{;} NL}	Cycle Life TEST:1~2000, n=1~3
[PRESet:]BATT:DYN{SP}{ON OFF}	Cycle Life TEST ON/OFF
[PRESet:]BATT:CC{n}{SP}{NR2}{;} NL}	Ramp Current, n=0~9
[PRESet:]BATT:CV{n}{SP}{NR2}{;} NL}	Ramp Voltage, n=0~9
[PRESet:]BATT:DTIME{n}{SP}{NR1}{;} NL}	Ramp Delta time (T1~T9:0~6000sec), n=0~9
[PRESet:]BATT:REPEAT{SP}{n}{;} NL}	Cycle Life TEST / Ramp Repeat times:0~9999

[PRESet:]BATT:RAMP:CC{SP}{ON OFF}	RAMP CC TEST ON/OFF
[PRESet:]BATT:RAMP:CV{SP}{ON OFF}	RAMP CV TEST ON/OFF
[PRESet:]SURGE:SURI{NR2}{; NL}	
[PRESet:]SURGE:NORI{NR2}{; NL}	
[PRESet:]SURGE:TIME{NR2}{; NL}	SURGE TIME:10~1000ms
[PRESet:]SURGE:STEP{SP}{n}{; NL}	n=1~5
[PRESet:]SURGE{ON OFF}{; NL}	ON:RUN SURGE, OFF:STOP
[PRESet:]CPRSP{SP}{n}{; NL}	n=0~4
[PRESet:]AVG{SP}{n}{; NL}	
[PRESet:]FAN{SP}{n}{; NL}	n=1~3

Table: Communication Interface programming query command summary

QUERY COMMAND SUMMARY	RETURN
[PRESet:]RISE{?}{; NL}	###.####
[PRESet:]FALL{?}{; NL}	###.####
[PRESet:]PERI PERD:{HIGH LOW}{?}{; NL}	###.####
[PRESet:]LDONv{?}{; NL}	###.####
[PRESet:]LDOFfv{?}{; NL}	###.####
[PRESet:]CC CURR:{HIGH LOW}{?}{; NL}	###.####
[PRESet:]CP:{HIGH LOW}{?}{; NL}	###.####
[PRESet:]CR RES:{HIGH LOW}{?}{; NL}	###.####
[PRESet:]CV VOLT:{HIGH LOW}{?}{; NL}	###.####
[PRESet:]TCONFIG{?}{; NL}	1:NORMAL, 2:OCP 3:OPP, 4:SHORT
[PRESet:]OCP: START{?}{; NL}	###.####
[PRESet:]OCP: STEP{?}{; NL}	###.####
[PRESet:]OCP: STOP{?}{; NL}	###.####
[PRESet:]VTH{?}{; NL}	###.####
[PRESet:]OPP: START{?}{; NL}	###.####
[PRESet:]OPP: STEP{?}{; NL}	###.####
[PRESet:]OPP: STOP{?}{; NL}	###.####
[PRESet:]STIME{?}{; NL}	###.####

[PRESet:]MPP{?}; NL}	READ MPP DATA “V/I/P” or “END”
[PRESet:]MPPTIME{?}; NL}	#####
[PRESet:]BATT:RAH{?}; NL}	READ BATT TEST RESULT AH
[PRESet:]BATT:RWH{?}; NL}	READ BATT TEST RESULT WH
[PRESet:]BATT:RTIME{?}; NL}	READ BATT TEST RESULT TIME
[PRESet:]BATT:RVOLT{?}; NL}	READ BATT TEST RESULT VOLTAGE
[PRESet:]CPRSP{?}; NL}	n=0~4, 0:Fast, 4:Slow
[PRESet:]AVG{?}; NL}	
[PRESet:]FAN{?}; NL}	

Table: Communication Interface programming limit command summary

LIMIT	RETURN
LIMit:CURRent:{HIGH LOW}{SP}{NR2}; NL}	
LIMit:CURRent:{HIGH LOW}{?}; NL}	###.####
IH IL{SP}{NR2}; NL}	
IH IL{?}; NL}	
LIMit:POWer:{HIGH LOW}{SP}{NR2}; NL}	
LIMit:POWer:{HIGH LOW}{?}; NL}	###.####
WH WL{SP}{NR2}; NL}	
WH WL{?}; NL}	###.####
LIMit:VOLTagE:{HIGH LOW}{SP}{NR2}; NL}	
LIMit:VOLTagE:{HIGH LOW}{?}; NL}	###.####
VH VL{SP}{NR2}; NL}	
VH VL{?}; NL}	###.####
SVH SVL{SP}{NR2}; NL}	
SVH SVL{?}; NL}	###.####
[LIMit:]ADDCV:VOLTagE{SP}{NR2}; NL}	
[LIMit:]ADDCV:VOLTagE{?}; NL}	###.####
[LIMit:]ADDCV{SP}{ON OFF}; NL}	

Table: STAGE COMMAND SUMMARY

STAGE COMMAND	REMARK
[STaTe:]LOAD{SP}{ON OFF}{; NL}	
[STaTe:]LOAD{?}{; NL}	0:OFF, 1:ON
[STaTe:]MODE{SP}{CC CR CV CP}{;NL}	
[STaTe:]MODE{?}{; NL}	0 1 2 3:CC CR CV CP
[STaTe:]SHORt{SP}{ON OFF}{; NL}	
[STaTe:]SHORt{?}{; NL}	0:OFF, 1:ON
[STaTe:]PRESet{SP}{ON OFF}{; NL}	
[STaTe:]PRESet{?}{; NL}	0:OFF, 1:ON
[STaTe:]SENSe{SP}{ON OFF AUTO}{; NL}	
[STaTe:]SENSe{?}{; NL}	0:OFF/AUTO, 1:ON
[STaTe:]LEVEl{SP}{ LOW HIGH}{; NL}	
[STaTe:]LEVEl{?}{; NL}	0:LOW, 1:HIGh
[STaTe:]LEV{SP}{LOW HIGH}{; NL}	
[STaTe:]LEV{?}{; NL}	0:LOW, 1:HIGh
[STaTe:]DYNaMic{SP}{ON OFF} {; NL}	
[STaTe:]DYNaMic{?}{; NL}	0:OFF, 1:ON
[STaTe:]CLR{; NL}	
[STaTe:]ERRor{?}{; NL}	
[STaTe:]NO{SP}GOOD{?}{; NL}	0:GO, 1:NG
[STaTe:]NG{?}{; NL}	0:GO, 1:NG
[STaTe:]PROTEct{?}{; NL}	
[STaTe:]CC{SP}{AUTO R2}{; NL}	
[STaTe:]NGENABLE{SP}{ON OFF}{; NL}	
[STaTe:]POLAR{SP}{POS NEG}{; NL}	
[STaTe:]START{; NL}	
[STaTe:]STOP{; NL}	
[STaTe:]TESTING{?}{; NL}	0:TEST END, 1:TESTING

Table: SYSTEM COMMAND SUMMARY

COMMAND	NOTE	RETURN
[SYStem:]RECall{SP}{m}{; NL}	m=1~150	
[SYStem:]STORe{SP}{m}{; NL}	m=1~150	
[SYStem:]REMOtE{; NL}	RS232/USB/LAN command	
[SYStem:]LOCAL{; NL}	RS232/USB/LAN command	

[SYStem:]NAME{?}; NL}	“XXXXXX”
-----------------------	----------

Table: MEASURE COMMAND SUMMARY

COMMAND	RETURN
MEASure:CURRent{?}; NL}	###.####
MEASure:VOLTag{?}; NL}	###.####
MEASure:POWer{?}; NL}	###.####
MEASure:VC{?}; NL}	###.####,###.####

- Remark
1. Current engineering unit: A
 2. Voltage engineering unit: V
 3. Resistance engineering unit: Ω
 4. Period engineering unit: mS
 5. Slew-rate engineering unit: A/μS
 6. Power engineering unit: W

Table: AUTO SEQUENCE COMMAND

AUTO SEQUENCE COMMAND	NOTE	RETURN
FILE{SP}{n}; NL}	n=1~9	1~9
STEP{SP}{n}; NL}	n=1~16	1~16
TOTSTEP{SP}{n}; NL}	Total step n=1~16	1~16
SB{SP}{m}; NL}	m=1~150 m:STATE	
TIME{SP}{NR2}; NL}	100~9999 (ms)	100~9999 (ms)
SAVE{ NL}	Save “File n” data	
REPEAT{SP}{n}; NL}	n=0~9999	0~9999
RUN{SP}{F}{n}; NL}	n=1~9	AUTO REPLY “PASS” or “FAIL:XX” (XX=NG STEP)

Command Syntax

The description of abbreviation

Command Tree SP: Space, the ASCII code is 20 Hexadecimal.
 ;:Semicolon, Program line terminator, the ASCII code is 0A Hexadecimal.
 NL:New line, Program line terminator, the ASCII code is 0A Hexadecimal.
 NR2:Digits with decimal point. It can be accepted in the range and format of ###.#####.
 For Example:
 30.12345, 5.0
 The description of GPIB programming command syntax.

Communication Interface programming command syntax description

{ }	The contents of the { } symbol must be used as a part or data of the GPIB command, it cannot be omitted.
[]	The contents of the [] symbol indicates the command can be used or not. It depends on the testing application.

| This symbol means option. For example “LOW | HIGH” means it can only use LOW or HIGH as the command, it can choose only one as the setting command.

Terminator: You have to send the program line terminator character after send the GPIB command, the available command terminator characters which can be accepted in PEL-5000C series mainframe is listed in table below

LF
LF WITH EOI
CR , LF
CR , LF WITH EOI

Semicolon “;”:The semicolon “;” is a back-up command, the semicolon allows you to combine command statement on one line to create command message.

Command List

PRESET Commands.....	116
RISE.....	116
FALL.....	116
PERI or PERD.....	117
LDONv.....	117
LDOFv.....	117
CURR: HIGH LOW.....	118
CP: {HIGH LOW}.....	118
CR RES: {HIGH LOW}.....	119
CV: {HIGH LOW}.....	119
OCP:START.....	120
OCP:STEP.....	120
OCP:STOP.....	120
OCP.....	121
VTH.....	121
OPP:START.....	121
OPP:STEP.....	121
OPP:STOP.....	122
OPP.....	122
TCONFIG.....	122
STIME.....	123
MPPT.....	123
MPP.....	123
MPPTIME.....	123
BATT: UVP.....	124
BATT:TIME.....	124
BATT:STEP.....	124
BATT:CCH.....	125
BATT:CCL.....	125
BATT:TH.....	125
BATT:TL.....	125
BATT:CYCLE.....	126
BATT:CC.....	126
BATT:DTIME.....	126
BATT:REPEAT.....	126
SURGE:SURI.....	127
SURGE:NORI.....	127
SURGE:TIME.....	127
SURGE:STEP.....	127
SURGE:ON OFF.....	128

CPRSP	128
AVG	128
FAN	128
Limit Commands	129
[LiMit:]CURRent: {HIGH LOW} or IH IL	129
[LiMit:]POWer: {HIGH LOW} or WH WL	129
[LiMit:]VOLtage: {HIGH LOW} or VH VL	129
SVH SVL	130
[LiMit:]ADDCV: VOLtage	130
[LiMit:]ADDCV:VOLtage {SP} {ON OFF}	131
STAGE commands.....	132
[STATe:]LOAD {SP} {ON OFF}	132
[STATe:]MODE {SP} {CC CR CV CP}	132
[STATe:]SHORt {SP} {ON OFF}	133
[STATe:]PRESet {SP} {ON OFF}	133
[STATe:]SENSe {SP} {ON OFF AUTO}	133
[STATe:]LEVel {SP} {HIGH LOW} or LEV {SP} {HIGH LOW}	134
[STATe:] DYNAmic {SP} {ON OFF}	134
[STATe:]CLR	135
[STATe:]NG?	135
[STATe:]PROTeCt?	135
[STATe:]CCR {AUTO R2}	136
[STATe:]NGEABLE {ON OFF}	136
[STATe:]POLAR {POS NEG}	136
[STATe:]START	136
[STATe:]STOP	137
System Commands	138
[SYStem:]RECall {SP} m {,n}	138
[SYStem:]STORe {SP} m {,n}	138
[SYStem:]NAME?	138
[SYStem:]REMOTE	139
[SYStem:]LOCAL	139
Measure Commands	140
MEASure:CURRent?	140
MEASure:VOLtage?	140
MEASure:POWer?	140

PRESET Commands

RISE

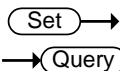

Description	<p>Set and read the RISE SLEW-RATE.</p> <ul style="list-style-type: none"> • The definition of RISE SLEW-RATE is load level change or dynamic load can be programmed of RISE and FALL are completely independent. • The value of RISE has to be included the number of the decimal point, otherwise the command will not be available. • The least significant number is the 3th behind the decimal point. • PEL-5000C series will set to the maximum value of the model automatically when the set RISE is over the specification of Load. • The unit is A/uS.
-------------	--

Syntax [PRESet:]RISE{SP}{NR2}{;NL}

Query Syntax [PRESet:]RISE{?}{;NL}

FALL

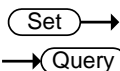

Description	<p>Set and read the linear current. Set and read the FALL SLEW-RATE</p> <ul style="list-style-type: none"> • The definition of FALL SLEW-RATE is load level change or dynamic load can be programmed of RISE and FALL are completely independent. • PEL-5000C series will set to the maximum value of the model automatically when the FALL which has been set is over the specification of Load. • The unit is A/uS.
-------------	--

Syntax [PRESet:]FALL{SP}{;}|NL}

Query Syntax [PRESet:]FALL{?}{;}|NL}

Set →

→ Query

PERI or PERD

Description Set and read the TLOW and Thigh of DYNAMIC when loading.

- A period of loading waveform of DYNAMIC is combined by TLOW and THIGH.
- The value of TLOW and THIGH have to be included the number of the decimal point, otherwise the command will not be available.
- The least significant number is the 5th behind the decimal point.
- PEL-5000C Series will set the value of TLOW or THIGH automatically when the value which has been set is over the maximum of the Load.
- The unit is mS.

Syntax [PRESet:]PERI|PERD:HIGH|LOW{SP}{NR2}{;}|NL}

Query Syntax [PRESet:]PERI|PERD:HIGH|LOW{?}{;}|NL}

Set →

→ Query

LDONv

Description Set and Read the voltage of LOAD ON This command is for setting the Load voltage value of LOAD ON.

Syntax [PRESet:]LDONv{SP}{NR2}{;}|NL}

Query Syntax [PRESet:]LDONv{?}{;}|NL}

Set →

→ Query

LDOFFv

Description Set and read the voltage of LOAD OFF. This command is for setting the Load voltage value of LOAD OFF.

Syntax [PRESet:]LDOFv{SP}{NR2}{;|NL}
 Query Syntax [PRESet:]LDOFv{?}{;|NL}

CURR: HIGH|LOW

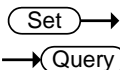

Description Set and read the current of HIGH | LOW. This command is for setting the required Load current. And this command must be followed the next notices:

- The required value of current must be included the number of the decimal point, otherwise the command will not be available.
- The least significant number is the 5th behind the decimal point.
- PEL-5000C Series will set the maximum value of current of the load automatically when the value which has been set is over the maximum of the load.
- The value of LOW has to be smaller than HIGH.
- The unit is A

Syntax [PRESet:]CC|CURR:HIGH|LOW{SP}{NR2}{;|NL}
 Query Syntax [PRESet:]CC|CURR:HIGH|LOW{?}{;|NL}

CP:{HIGH|LOW}

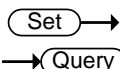

Description Set and read the value of watt. This command is for setting the required value of watt, and the unit is W

Syntax [PRESet:]CP:{HIGH|LOW}{SP}{NR2}{;|NL}
 Query Syntax [PRESet:]CP:{HIGH|LOW}{?}{;|NL}

CR|RES:{HIGH|LOW}

Set →

← Query

Description Set and read the value of resistance. This command is used for setting the required value of Load Resistance. And this command must be followed the next notices:

- The required value of resistance must be included the number of the decimal point, otherwise the command will not be available.
- The least significant number is the 3rd behind the decimal point.
- PEL-5000C Series will set to the maximum value of the model automatically when the value of Resistance which has been set is over the specification of load.
- The Resistance value which has been set of LOW has to be smaller than HIGH.
- The unit is Ω .

Syntax [PRESet:]CR|RES:{HIGH|LOW}{SP}{NR2}{;|NL}

Query Syntax [PRESet:]CR|RES:{HIGH|LOW}{?}{;|NL}

CV:{HIGH|LOW}

Set →

← Query

Description Set and Read the value of load voltage. This command is used for setting the required Load Voltage. And this command must be followed the next notices:

- The required value of resistance must be included the number of the decimal point, otherwise the command will not be available.
- The least significant number is the 5th behind the decimal point.
- PEL-5000C Series will set to the maximum value of the model automatically when the value of Voltage which has been set is over the

specification of load.

- The Voltage value which has been set of LOW has to be smaller than HIGH.
- The unit is voltage (V)

Syntax [PRESet:]CV:{HIGH|LOW}{SP}{NR2}{;|NL}

Query Syntax [PRESet:]CV:{HIGH|LOW}{?}{;|NL}

OCP:START

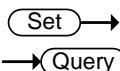

Description Set and read the initial value of OCP test. This command is used for setting the required initial value (I-START) of OCP

Syntax [PRESet:]OCP:START{SP}{NR2}{;|NL}

Query Syntax [PRESet:]OCP:START{?}{;|NL}

OCP:STEP

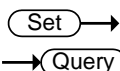

Description Set and read the increasing value of OCP test. This command is used for setting the increasing value (I-STEP) of OCP test.

Syntax [PRESet:]OCP:STEP{SP}{NR2}{;|NL}

Query Syntax [PRESet:]OCP:STEP{?}{;|NL}

OCP:STOP

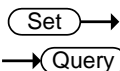

Description Set and read the maximum value of OCP test. This command is used for setting the maximum value (I-STOP) of OCP

Syntax [PRESet:]OCP:STOP{SP}{NR2}{;|NL}

Query Syntax [PRESet:]OCP:STOEP{?}{;|NL}

OCP → Query

Description Read OCP testing current. This command is used for reading OCP current.

Query Syntax OCP{?}

Set →
VTH → Query

Description Set and read the maximum value of OCP test. This command is used for setting the maximum value (I-STOP) of OCP Set and read the value of the threshold voltage. This command is used for setting the Threshold Voltage. That is the OCP/OPP of this Load model when the output voltage of appliance is lower or equaled to the VTH.

Syntax [PRESet:]VTH{SP}{NR2}{;|NL}

Query Syntax [PRESet:]VTH{?}{;|NL}

Set →
OPP:START → Query

Description Set and read the initial value of OPP test. This command is used for setting the required initial value (P-START) of OPP

Syntax [PRESet:]VTH{SP}{NR2}{;|NL}

Query Syntax [PRESet:]VTH{?}{;|NL}

Set →
OPP:STEP → Query

Description Set and read the increasing value of OPP test. This command is used for setting the increasing value (P-STEP) of OPP Test.

Syntax [PRESet:]OPP:STEP{SP}{NR2}{;|NL}
 Query Syntax [PRESet:]OPP:STEP?}{;|NL}

OPP:STOP (Set) →
→ (Query)

Description Set and read the maximum value of OPP test. This command is used for setting the maximum value (P-STOP) of OPP

Syntax [PRESet:]OPP:STOP{SP}{NR2}{;|NL}
 Query Syntax [PRESet:]OPP:STOEP?}{;|NL}

OPP → (Query)

Description Read OPP testing watt. This command is used for reading OPP watt.

Query Syntax OPP{?}

TCONFIG (Set) →
→ (Query)

Description Set and read the function of Dynamic test. There are four options of this command. Those are NORMAL mode, OCP test, OPP test and SHORT test.

Syntax [PRESet:] TONFIG {NORMAL|OCP|OVP|OPP|SHORT}{;|NL}

Query Syntax [PRESet:] TONFIG?}{;|NL}

Return Parameter	<NR2>	
	1	NORMAL
	2	OCP
	3	OPP
	4	SHORT

		Set →
		→ Query
<hr/>		
STIME		
<hr/>		
Description	Set and read time of the short-circuit test. This command is used for setting time of the short-circuit test. If time set to 0, it means that have no the time limit and continue to be short -circuited. The unit is milli-second (ms)	
Syntax	[PRESet:]STIME{SP}{NR2}{; NL}	
Query Syntax	[PRESet:]STIME{?}{; NL}	
<hr/>		
		Set →
<hr/>		
Description	MPPT(Maximum power point tracking) testing ON/OFF. This command is MPPT ON/OFF	
Syntax	[PRESet:]MPPT{SP}ON OFF{; NL}	
<hr/>		
		→ Query
<hr/>		
MPP		
Description	Read MPP max power data, readback" Voltmeter / Ammeter / PowerMeter."	
Query Syntax	[PRESet:]MPP{?}{; NL}	
<hr/>		
		Set →
		→ Query
<hr/>		
MPPTIME		
Description	Set and read MPPTIME (Maximum power point tracking time). This command is MPPTIME maximum power point tracking time n=1000ms~60000ms	
Syntax	[PRESet:] MPPTIME{SP}{n}{; NL} [PRESet:] MPPTIME{?}{; NL}	
<hr/>		

Example	<ol style="list-style-type: none"> 1. Set MPPTIME 5000ms (maximum power point, read once every 5 seconds). 2. Set MPPT ON command. 3. Set MPP? command, readback "Voltmeter / Ammeter / PowerMeter." 4. Set MPP OFF command.
---------	--

BATT:UVP

Set →

Description	Set under voltage protect. This command is to set battery discharge test mode Disch CC or Disch CP under Voltage Protect voltage, unit is voltage (V).
-------------	--

Syntax	[PRESet:] BATT:UVP {SP}{NR2}{:}; NL}
--------	--------------------------------------

BATT:TIME

Set →

Description	Set battery discharge test mode time. This command is to set battery discharge test mode Disch CC or Disch CP discharge test time, n=1~99999, unit is second (S).
-------------	---

Syntax	[PRESet:]BATT:TIME{SP}{n}{:}; NL}
--------	-----------------------------------

BATT:STEP

Set →

Description	Set battery discharge test mode step. This command is to set battery discharge test mode Cycle Life test mode or RAMP Mode test mode, Cycle Life test mode setting step n=1~3, RAMP Mode test mode setting step n=1~9.
-------------	--

Syntax	[PRESet:]BATT:STEP{SP}{n}{:}; NL}
--------	-----------------------------------

BATT:CCH

Set →

Description Set battery discharge test mode cycle life test mode level high current. This command is to set battery discharge test mode Cycle Life test mode level high current value, n = 1~3, current value unit (A).

Syntax [PRESet:]BATT:CCH{n}{SP}{NR2}{:|NL}

BATT:CCL

Set →

Description Set battery discharge test mode cycle life test mode level low current. This command is to set battery discharge test mode cycle life test mode level low current value, n = 1~3, current is unit (A).

Syntax [PRESet:]BATT:CCL{n}{SP}{NR2}{:|NL}

BATT:TH

Set →

Description Set battery discharge test mode Cycle Life test mode level high testing time. This command is to set battery discharge test mode Cycle Life test mode level high time value, n=1~3, time is unit millisecond(ms).

Syntax [PRESet:]BATT:TH{n}{SP}{NR2}{:|NL}

BATT:TL

Set →

Description Set battery discharge test mode cycle life test mode level low testing time. This command is to set battery discharge test mode cycle life test mode level low time value, n=1~3, time is unit millisecond(ms).

Syntax [PRESet:]BATT:TL{n}{SP}{NR2}{:|NL}

BATT:CYCLE**Set** →

Description Set battery discharge test mode Cycle Life test mode testing cycle. This command is to set battery discharge test mode Cycle Life test mode testing cycle, n=1~3, cycle range is 1~2000.

Syntax [PRESet:] BATT:CYCLE{n} {SP}{NR1}{;|NL}

BATT:CC**Set** →

Description Set battery discharge test mode Ramp mode loading current. This command is to set battery discharge test mode Ramp mode loading current, n=1~9, current is unit (A).

Syntax [PRESet:] BATT:CC{n} {SP}{NR2}{;|NL}

BATT:DTIME**Set** →

Description Set battery discharge test mode Ramp mode time. This command is to set battery discharge test mode Ramp mode time, n=1~9, time range is 1 ~ 6000 second.

Syntax [PRESet:] BATT:DTIME{n} {SP}{NR1}{;|NL}

BATT:REPEAT**Set** →

Description Set battery discharge test mode Ramp mode number of repeated tests. This command is to set battery discharge test mode Ramp mode number of repeated tests, n=0~99999.

Syntax [PRESet:] BATT:REPEAT {SP}{n}{;|NL}

		Set →
		→ Query
<hr/>		
SURGE:SURI		
<hr/>		
Description	Set and read surge current mode loading current value. This command is to set and read surge current mode testing loading value XXX.XXX (A) SURGE CURRENT.	
Syntax	[PRESet:]SURGE:SURI{SP}{NR2}{: NL}	
Query Syntax	[PRESet:]SURGE:SURI{?}{: NL}	
<hr/>		
		Set →
		→ Query
<hr/>		
SURGE:NORI		
<hr/>		
Description	Set and read surge mode normal current test loading current value. This command is to set and read normal current testing mode loading current value XXX.XXX (A) NORMAL CURRENT.	
Syntax	[PRESet:]SURGE:NORI{SP}{NR2}{: NL}	
Query Syntax	[PRESet:]SURGE:NORI{?}{: NL}	
<hr/>		
		Set →
		→ Query
<hr/>		
SURGE:TIME		
<hr/>		
Description	Set and read surge mode current testing time. This command is to set and read surge mode testing time, SURGE TIME:10~1000ms	
Syntax	[PRESet:]SURGE:TIME{SP}{NR2}{: NL}	
Query Syntax	[PRESet:]SURGE:TIME{?}{: NL}	
<hr/>		
		Set →
		→ Query
<hr/>		
SURGE:STEP		
<hr/>		
Description	Set and read surge mode is Diminishing current is to set value. This command is to set and read surge mode Diminishing current setting value, n=1~5	
Syntax	[PRESet:]SURGE:STEP{SP}{NR2}{: NL}	
Query Syntax	[PRESet:]SURGE:STEP{?}{: NL}	
<hr/>		

SURGE:ON|OFF



Description	Set and read surge mode ON or OFF. This command is to set and read surge mode ON or OFF, ON:RUN SURGE, OFF:STOP
Syntax	[PRESet:]SURGE:ON OFF{; NL}
Query Syntax	[PRESet:]SURGE: SURGE{?}{; NL}

CPRSP



Description	Set CP mode RESPONSE. This command is to set CP mode RESPONSE, 0: Fast, 4: Slow, initial value 0.
Syntax	[PRESet:]CPRSP{n}{; NL}

AVG

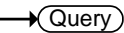

Description	Set and read voltage value/current value/watt vaqlue average times. This command is Vmeter/Ameter/Wmeter setting measure average times, MEAS AvG 1~64 setting, initial value 1.
Syntax	[PRESet:]AVG{SP}{n}{; NL}
Query Syntax	[PRESet:]AVG{?}{; NL}

FAN

Description	Set and read the operation mode of the cooling fan. This command is used to control the operation mode of the cooling fan. "1" is for standard operation mode, "2" is for increasing speed early and "3" is for full speed. The default setting is "1".
Syntax	[PRESet:]FAN{SP}{n}{; NL}
Query Syntax	[PRESet:]FAN{?}{; NL}

Limit Commands

[LIMit:]CURRent:{HIGH|LOW} or IH|IL Set →
→ Query

Description This command is to set the lower limit value of threshold current. When load sink current is lower than this lower limit value or higher than the upper limit value, NG indicating light will come on to indicate "NO GOOD".

Syntax [LIMit:]CURRent:{HIGH|LOW}{SP}{NR2}{:|NL}
[IH|IL]{SP}{NR2}{:|NL}

Query Syntax [LIMit:]CURRent:{HIGH|LOW}{?}{:|NL}
[IH|IL]{?}{:|NL}

[LIMit:]POWer:{HIGH|LOW} or WH|WL Set →
→ Query

Description This command is to set the upper/lower limit value of threshold power (WATT). When power (WATT) is lower than this lower limit value or higher than the upper limit value, NG indicating light will come on to indicate "NO GOOD".

Syntax [LIMit:]POWer:{HIGH|LOW}{SP}{NR2}{:|NL}
[WH|WL]{SP}{NR2}{:|NL}

Query Syntax [LIMit:]POWer:{HIGH|LOW}{?}{:|NL}
[WH|WL]{?}{:|NL}

[LIMit:]VOLtage:{HIGH|LOW} or VH|VL Set →
→ Query

Description This command is to set the upper/lower limit value of threshold voltage. When input voltage is lower than the lower limit value or higher than the upper limit value, NG indicating light will come on to indicate "NO GOOD".

Syntax [LIMit]:VOLTage:{HIGH|LOW}{SP}{NR2}{;|NL}
[VH|VL]{SP}{NR2}{;|NL}

Query Syntax [LIMit]:VOLTage:{HIGH|LOW}{?}{;|NL}
[VH|VL]{?}{;|NL}

SVH|SVL

Set →

→ Query

Description This command is to set the upper/lower limit value of short current. When short current is lower than the lower limit value or higher than the upper limit value, NG indicating light will come on to indicate “NO GOOD”.

Syntax [LIMit:]{SVH|SVL}{SP}{NR2}{;|NL}

Query Syntax [LIMit:]{SVH|SVL}{?}{;|NL}

[LIMit:]ADDCV: VOLTage

Set →

→ Query

Description Set and read CC+CV or CP+CV mode of Constant Voltage setting. This command is used for set and read Constant Voltage setting, when set to CC+CV, the of load like constant current status, until EUT Voltage equal setting constant voltage, into a constant voltage mode.

This command is used for setting and read constant Voltage setting, when set to CP+CV, the of Load like constant power status, until EUT Voltage equal setting constant voltage, into a constant voltage mode.

Syntax [LIMit:]ADDCV:VOLTage{SP}{NR2}{;|NL}

Query Syntax [LIMit:]ADDCV:VOLTage{SP}{?}{;|NL}

[LIMit:]ADDCV:VOLtage{SP}{ON|OFF} Set →

Description Start and stop CC+CV or CP+CV test mode. At that time in Constant current mode or constant power mode to perform CC + CV or CP + CV mode.

Syntax [LIMit:]ADDCV:VOLtage{SP}{ON|OFF}{;NL}

STAGE commands

Set and read the status of Load

[STATe:]LOAD{SP}{ON|OFF}



Description Set and read the status of sink current or not. This command is used for setting the status of sink current. When setting it to ON, the load is going to sink current from appliance. When setting it to OFF, the load would not act.

Syntax [STATe:]LOAD{SP}{ON|OFF}{;|NL}

Query Syntax [STATe:]LOAD{?}{;|NL}

Parameter	0	ON
	1	OFF

[STATe:]MODE{SP}{CC|CR|CV|CP}



Description Set and read the mode of load. Load is acting under these four modes as the following table. When reading the loading operation mode, the return value 0 | 1 | 2 | 3 | are meant to be CC | CR | CV | CP

Syntax [STATe:]MODE{SP}{CC|CR|CV|CP}{;|NL}

Query Syntax [STATe:]MODE{?}{;|NL}

Module for each series	Mode	CC	CR	CV	CP
	(value)	0	1	2	3
	PEL-5000C	V	V	V	V

[STATe:]SHORt{SP}{ON|OFF}



Description This command is for setting the load to make a short-circuit test. While setting for the ON, the V+, V- pin of load like short-circuit status.

Syntax [STATe:]SHORt{SP}{ON|OFF}{ ;|NL}

Query Syntax [STATe:]SHORt{?}{ ;|NL}

[STATe:]PRESet{SP}{ON|OFF}



Description Set the left or right digit multi-function meter to display the programming load level. This command is for select the left 5 digit LCD display to show current setting or DWM.

Pres ON: To select the LCD display to shows current setting.

Pres OFF: To select the LCD Display is "DWM"

Syntax [STATe:]PRESet{SP}{ON|OFF}{ ;|NL}

Query Syntax [STATe:]PRESet{?}{ ;|NL}

Parameter	0	OFF
	1	ON

[STATe:]SENSE{SP}{ON|OFF|AUTO}





Description Set and read the Load voltage to read whether is carried by the VSENSE or not. This command is for setting the load voltage to read whether is carried by VSENSE or INPUT Connector. When setting for ON, the voltage is got from VSENSE, and setting for OFF, the voltage is got from INPUT connector. In PEL-5000C Series, the optional are ON and AUTO. So, if setting for AUTO, it means the voltage is got and read from VSENSE. But if no voltage is inputted from VSENSE, the voltage will

be inputted from INPUT Connector.

Syntax [STATe:]SENSe{SP}{ON|OFF|AUTO }{;|NL}

Query Syntax [STATe:]SENSe{?}{;|NL}

[STATe:]LEVEl{SP}{HIGH|LOW} or LEV{SP}{HIGH|LOW }



Description Set and read the LOW and HIGH of load. LEV LOW is a low level value of current on CC mode. It is a low level value of resistance on CR mode. It is a low level value of voltage on CV mode. It is a low level value of power on CP mode.

Syntax [STATe:]LEVEl{SP}{HIGH|LOW }{;|NL}

[STATe:]LEV{SP}{HIGH|LOW }{;|NL}

Query Syntax [STATe:]LEVEl{?}{;|NL}

[STATe:]LEV{?}{;|NL}

Parameter	0	LOW/A
	1	HIGH/B

[STATe:] DYNamic {SP}{ON|OFF}

Description Set and read whether the status is dynamic or static of load

1. DYN ON , set for a DYNAMIC Load
2. DYN OFF, set for a STATIC Load

Syntax [STATe:]DYNamic{SP}{ON|OFF}{;|NL}

Query Syntax [STATe:]DYNamic{?}{;|NL}

[STATe:]CLR

Set →

Description Clear the error flag of PEL-5000C Series which during the period of working. This command is for clearing the contents in the register of PROT and ERR. After implementation, the contents of these two registers will be "0".

Syntax [STATe:]CLR{;|NL}

[STATe:]NG?

→ Query

Description Query if there have NG flag in this PEL-5000C Series. Set command NG? To show the NG status. Set for "0" the LCD of NG (NO GOOD) will be put out. Set "1", the LCD will be lit.

Query Syntax [STATe:]NG{?}{;|NL}

Return Parameter	0	GO
	1	NG

[STATe:]PROTect?

→ Query

Description Query if there have protection flag which had been set in this PEL-5000C series.

PROT? Means the status of protection of PEL-5000C. "1" means OPP occurred. "4" means OVP. "8" means OCP. The table below shows the corresponding number of protection status use command CLR to clear the register of PROT status to be "0"

Query Syntax [STATe:]PROTect{?}{;|NL}

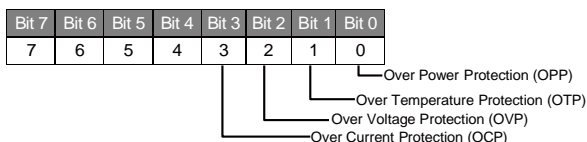

Register of PROT status	BIT ID	BIT VALUE	REMARK
	bit 0	0 = Off, 1 = Triggered	Over Power Protection (OPP)
	bit 1	0 = Off, 1 = Triggered	Over Temperature Protection (OTP)
	bit 2	0 = Off, 1 = Triggered	Over Voltage Protection (OVP)
	bit 3	0 = Off, 1 = Triggered	Over Current Protection (OCP)

[STATe:]CCR{AUTO|R2}

Description Set the CC MODE RANGE to be forced to switch to RANGE II. It will switch the RANGE position automatically when setting for AUTO Set R2 when implementing RANGE II

Syntax [STATe:]CCR{AUTO|R2}{;|NL}

[STATe:]NGEABLE {ON|OFF}

Description Set the GO/NG check function enable or disable. To set the function of NG judgment opens when POWER ON. When setting for POWER OFF, the function of NG judgment will not be implemented.

Syntax [STATe:]NGEABLE{ON|OFF}{;|NL}

[STATe:]POLAR{POS|NEG}

Description Set for the display of the voltage meter shows the pole is contrary or not. Set the display of the voltage meter shows the pole. If it shows POS that means the pole is not contrary. If the pole is contrary, it will show NEG.

Syntax [STATe:]POLAR {POS|NEG}{;|NL}

[STATe:]START

Description Set for load to implement the test, and according to TEST CONFIG (TCONFIG), the Load will start to test the items and parameters which are required

Syntax [STATe:]START{;|NL}

[STATe:]STOP

Set →

Description Set for load to stop the test

Syntax [STATe:]STOP{;|NL}

System Commands

Set and Read the Status of PEL-5000C Series

[SYStem:]RECall{SP}m{n}

Set →

Description Recall the status of loading which had been saved in the Memory. This command is for recalling the status of Load which had been saved in the Memory. m(STATE)=1~150.

Syntax [SYStem:]RECall{SP}m{;|NL}

Example RECALL 2

Recall the status of Loading which had been saved in the 2nd of the memory

[SYStem:]STORE{SP}m{n}

Set →

Description Save the status of Loading to the Memory. This command is for saving the status of Loading to the Memory. m(STATE)=1~150

Syntax [SYStem:]STORE{SP}m{;|NL}

Example STORE 2

Save the status of loading which had been saved in the 2nd of memory.

[SYStem:]NAME?

→ Query

Description Read the model number of Load. This command is for reading the model number of Load. If no module is operating, the display will be lit "NULL", or it will be lit the model number.

Query Syntax [SYStem:]NAME{?}{;|NL}

[SYStem:]REMOTE**Set** →

Description	Command to enter the REMOTE status (only for RS232). This command is for controlling the RS232
Syntax	[SYStem:]REMOTE{; NL}

[SYStem:]LOCAL**Set** →

Description	Command to exit the REMOTE status (only for RS232). This command is for finishing the RS232
Syntax	[SYStem:]LOCAL{; NL}

Measure Commands

Measure the actual current and voltage value of Load

MEASure:CURRent?

→ Query

Description Read the current which is loading from load. Read the five numbers of current meters, and the unit is Ampere (A)

Query Syntax MEASure:CURRent{?}{:|NL}

MEASure:VOLTage?

→ Query

Description Read the voltage which is loading from load. Read the five numbers of current meters, and the unit is Voltage (V)

Query Syntax MEASure:VOLTage{?}{:|NL}

MEASure:POWer?

→ Query

Description Read the power which is loading from load. Read the five numbers of current meters, and the unit is Watt (W)

Query Syntax MEASure:POWer{?}{:|NL}

A APPLICATION

This chapter details the basic operating modes along with some common applications in which the PEL-5000C series Electronic Load is used.

Local sense connections	143
Remote sense connections	144
Constant Current mode application	146
Constant Voltage mode application	149
Constant Resistance mode application	151
Constant Power mode application	153
Applications with current limiting or power limiting function CV mode operation (Charging device).....	155
Applications with current limiting or power limiting function CV mode operation (Discharging device).....	157
Application with switching from CP mode to CV mode operation (battery discharge)	159
Constant current source operating	161
Zero-Volt loading application.....	162
Parallel operation	163
Power Supply OCP testing	164
Power Supply OPP testing	166
SHORT testing	168
OCP, OPP, SHORT operation flow Chart.....	170
Battery discharge test	171
Disch CC / Disch CP measure discharge capacity.....	171
Cycle Life test	171
RAMP Mode.....	172

REMOTE Command Description	173
Cycle Life test.....	173
RAMP Mode	174

Local sense connections

Background

Local sensing is used in applications where the lead lengths are relatively short, or where load regulation is not critical. When connected in local sense mode the 5 digit voltage meter of the PEL-5000C series Electronic load measures the voltage at its DC input terminals. The connecting leads between the DUT and the Electronic Load should be bundled or tie wrapped together to minimize inductance.

The diagram below illustrates a typical set up with the electronic load connected to the DC power supply.

Local voltage sense connections

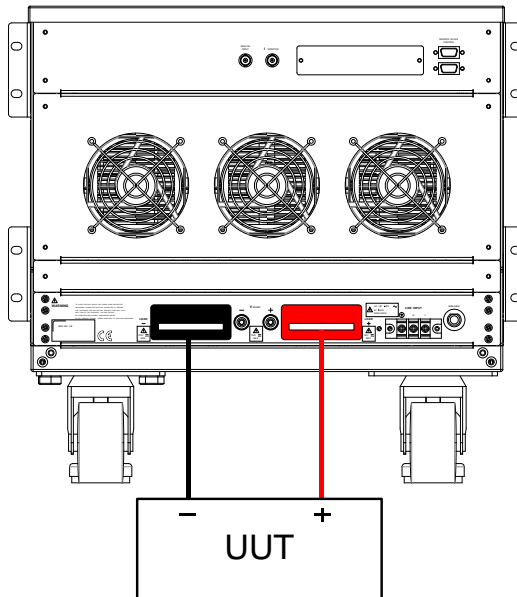

Remote sense connections

Background

Remote sensing compensates for the voltage drop in applications that require long lead lengths. It is useful under low voltage high current conditions. The remote voltage sense terminals (Vs+) and (Vs-) of the load are connected to (+) and (-) output of the DC Source. Be sure to observe the correct polarity or damage may occur. The power and sense cables should be bundled or tie wrapped together to minimize inductance.

The diagram below illustrates a typical set up with the electronic load connected for remote sense operation.

If V-sense is set to "ON" and the sense terminals are connected to the DUT the load will check and compensate for all voltage drops. The maximum voltage sense compensation is the same as the rating of the PEL-5006C-150-600.

Example

V_{max} of PEL-5006C-150-600 is 150Vdc so maximum V_{sense} is also 150Vdc.

V_{max} of PEL-5006C-600-420 is 600Vdc so maximum V_{sense} is also 600Vdc.

V_{max} of PEL-5006C-1200-240 is 1200Vdc so maximum V_{sense} is also 1200Vdc.

Remote voltage
sense
connections

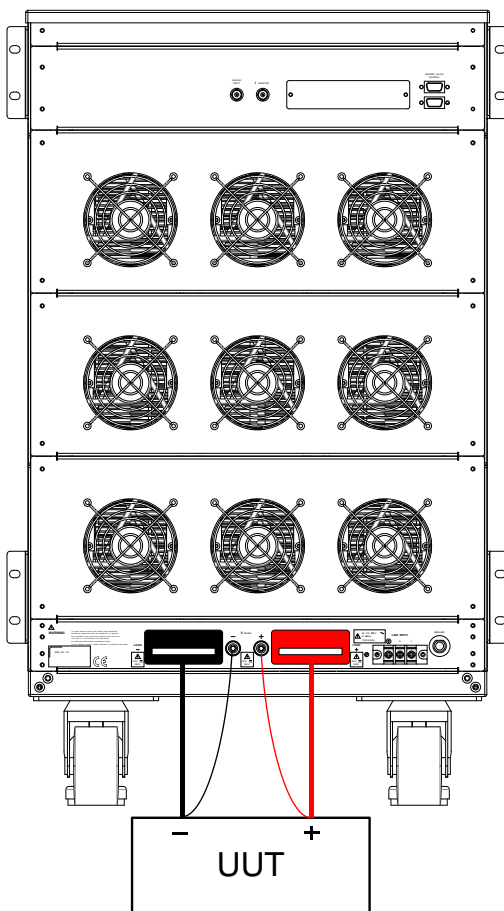

Constant Current mode application

Background

The Constant Current (CC) mode is ideal for testing the Load Regulation, Cross Regulation, Output Voltage and Dynamic Regulation of the power supply under test. The CC mode can also be used to test the Discharge Characteristics and the Life Cycle of cells and battery packs. In CC operation the PEL-5000C series can operate as a static load with switchable high and low current levels. It is also possible to operate the load dynamically enabling the user to adjust sink current with time.

Static mode

Major application areas include:

- Voltage source testing
 - Power supply load regulation testing
 - Battery discharge testing
-

Constant current mode application

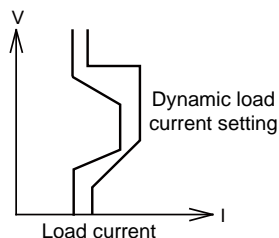
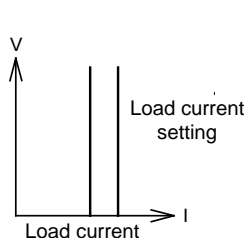
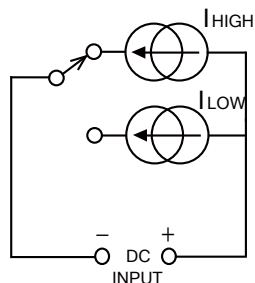
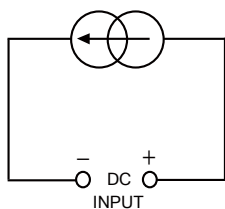
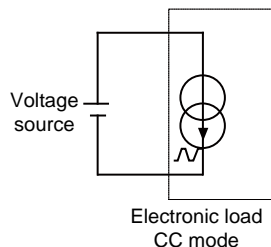
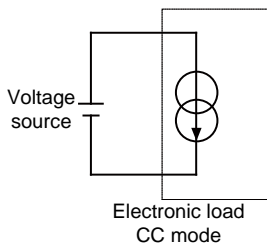

Dynamic mode

The built-in pulse generators allow the user to recreate real world loads that vary with time.

Major application areas include:

Power supply load transient response testing

Power recovery time testing

Battery Pulse load simulation

Power component testing

Two levels of current can be set and the rate of change between the 2 current levels can be adjusted in relation to time. The current rise (slew) rate and the current fall (slew) rate can be adjusted

independently from each other and are further defined below.

$$\text{Rise slew rate} = | I_{\text{low}} - I_{\text{high}} | / T_a \text{ (A/us)}$$

$$\text{Fall slew rate} = (I_{\text{high}} - I_{\text{low}}) / T_b \text{ (A/us)}$$

$$\text{Rise time}(T_a) = (I_{\text{low}} - I_{\text{high}}) / \text{Rise slew rate}$$

$$\text{Fall time}(T_b) = (I_{\text{high}} - I_{\text{low}}) / \text{Fall slew rate}$$

The time the waveform is high (T_{high}) and the time the waveform is low (T_{low}) can also be adjusted. The diagram below shows the 6 adjustable parameters that define the dynamic waveform.

Analogue programming input

The analogue programming input can also be used in CC mode. The analogue programming input allows a complex dynamic waveform to be set up on an external oscillator. The PEL-5000C series load will track and load according to the external signal as long as it is within its dynamic capability. The input signal can be the range of 0-10V (dc+ac). The 10V is proportional to the full current capability of the load.

Dynamic load current with independent programmed Rise/Fall slew rate

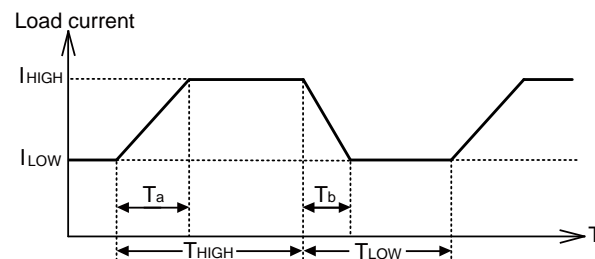

Constant Voltage mode application

Background	<p>In Constant Voltage (CV) operation the load will attempt to sink as much current as required in order to reach the set voltage value. CV operation is useful in checking the load regulation of dc current sources. The CV mode is also ideal for characterizing the current limit of dc power supplies. These application areas are explained a little more below.</p>
Current source testing	<p>A common application for a dc current source is as a battery charger. Most battery chargers are designed to automatically adjust their charging current according to the battery voltage. In CV mode the electronic load will sink the current that is needed to reach the desired voltage. The CV mode is therefore ideal for checking the charge current at a particular voltage level.</p> <p>If the battery charger is tested at a number of different voltage levels in CV mode a current curve can be recorded. Thus the battery charger's load regulation can be checked during development, production and batch testing.</p>
Power supply current limit characterization	<p>The current limit is a necessary function for power supplies. The fold back current limit curve is very common for fixed output switching power supplies. The constant current limit curve is more popular for adjustable laboratory power supplies.</p> <p>It is very difficult or impossible to find the current limit curve by CC or CR mode. However it becomes simple by using CV mode. The user sets the CV voltage and Records the output current. Plotting the current measurements against the voltage Settings result in the output current limit curve of a power supply</p>

Constant Voltage mode application

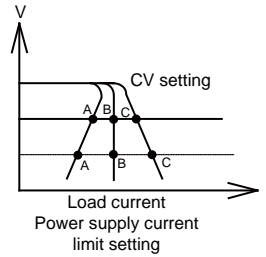
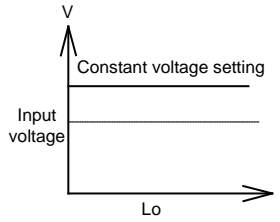
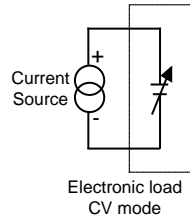
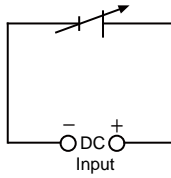

Constant Resistance mode application

Background	Operating in Constant Resistance mode is useful for testing both voltage and current sources. The CR mode is particularly suited for the “soft start” of power supplies. This is explained in more detail below.
Power supply power up sequence	In constant current mode the demand at initial “Load ON” of the preset current value is almost instantaneous. This might cause the Device under Test (DUT) problems meeting the relatively high current demand at initial switch on.
Example	<p>A 5V/50A output power supply may not be able to deliver 50A over its entire start-up range of 0-5 volts. In many cases the power supply’s short circuit or over current protection circuit cause the power supply to shut down. This is because the power supply is trying to deliver the 50A at a voltage level that is too low.</p> <p>The answer to this problem is not to use CC mode but to use CR mode instead. This is because in CR mode the current and voltage ramp up together providing a ‘soft start’ when compared to standard CC mode.</p> <p>However please note that with the PEL-5000C Series of Electronic Loads allow an adjustable current ramp can be set. This feature is found within the dynamic settings as RISE slew rate. Even in static mode the PEL-5000C Series load will regulate its current demand at “Load ON” in line with the adjusted RISE slew rate. The FALL slew rate also in the dynamic settings allows the current ramp down to be controlled at “Load OFF”.</p>

Constant Resistance mode Application

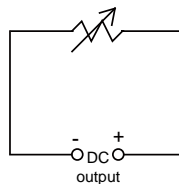
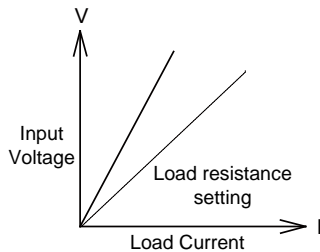
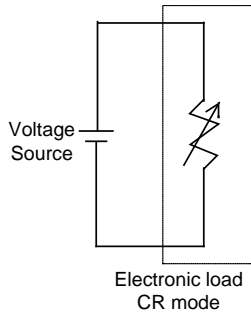
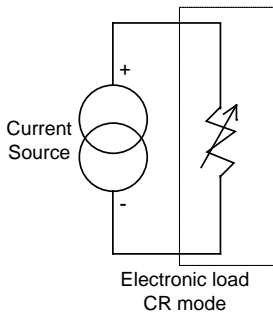

Constant Power mode application

Background

Battery Evaluation

Primary or secondary batteries are the power source for a wide range of portable electronics products, such as notebook computers, video cameras and mobile phones. To ensure long usage times and customer satisfaction the battery pack should be able to provide a constant power for the longest time possible.

It can be measured that the output voltage of a battery will drop over time (Fig a). The rate of voltage decay depends on a number of factors including duty cycle, chemistry type, battery age and ambient temperature.

So to keep the device powered for the longest possible time the battery must be able to provide a stable power output regardless of output voltage (Fig c). In order to maintain a constant power the output current will need to increase over time to compensate for the reducing voltage (Fig b).

Operating the PEL-5000C series electronic load in CP mode is ideal for testing the characteristics of a battery. This is because as the battery voltage drops the load current will automatically increase in order to keep the CP setting. By logging sink values against time the test engineer can also measure the battery's energy capacity at various discharge rates.

The PEL-5000C series also features an adjustable Load OFF setting. This allows a voltage level to be set so that the electronic load automatically stops sinking power upon reaching this preset voltage. This can be used to ensure the battery is not subjected to a damaging deep discharge.

Along with static operation the load can also be

operated dynamically in CP mode. The dynamic functions allow the ramp, fall and plateau times to be adjusted between 2 levels of power. This capability means that 'real world' loads can be more accurately simulated. For example the dynamic mode could be used to test the performance of a battery that is required to provide power pulses to transmit data from a radio frequency terminal.

Constant power mode application

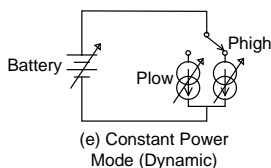
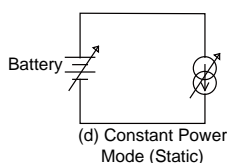
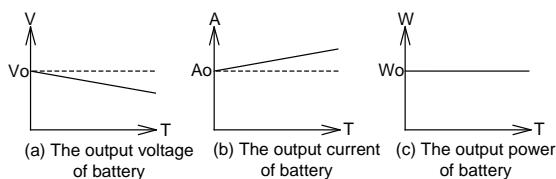

 Note

To use CP mode to do battery discharge test when CPRSP = 0(definition is 0), the ... Too long wire may cause oscillation and stop the test. The solution as below.

1. Use Vsense function Connect Vsense for voltage drop compensation
2. Use CPRSP = 1~4 to slower the CP mode response speed, the CPRSP setting in the Config key.

CPRSP settings will not be stored when turned off, When the PEL-5000C power is turned on, the CPRSP gear position must be set.

Applications with current limiting or power limiting function CV mode operation (Charging device)

Background

When operating in the current-limiting CV mode, the PEL-5000C series can limit current or power when operating at a constant voltage load. It is especially suitable for charging piles, constant current sources and other power product testing applications.

Operation method:

- Connect the DUT to the LOAD INPUT terminal
- Switch the electronic load to CC Mode or CP Mode first, and press the Preset key to set the current limit point or power limit point.
- Press the Limit key, and "Add.CV" will appear on the LCD display. At this time, after setting the CV value to be set, press START KEY to start the test.
- If you need to modify the current limit or power limit during the test, you can change the current limit or power limit after pressing the Preset button again.
- If you need to change the CV test point during the test, press the Limit button again, and "Add.CV" will appear on the LCD screen again. At this time, the CV setting value can be changed.
- Finally, press STOP KEY to stop the test.

I/V Curve

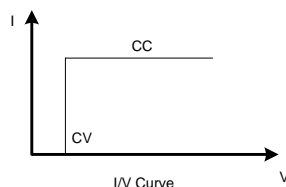

Remote control CV + current limit or power limit

REMOTE	(Set Remote Control)
MODE CC or CP	(Set to CC or CP mode)
CC: HIGH 20 or MODE CC or CP	(Set current limit to 20A or limit power 2000W)
LIM: ADDCV:VOLT 50	(Set the constant voltage is 50V)
LIM: ADDCV ON	(Start testing CV + current limit or power limit mode)
LIM: CURR?	(Read the current value of the electronic load)
LIM: VOLT?	(Read the voltage value of the electronic load)
LIM: ADDCV: CURR 25	(Modify the current limit point to 25A during the test)
LIM: ADDCV: POW 2500	(Modify the power limit point to 2500W during the test)
LIM: ADDCV: VOLT 40	(Modify the Constant voltage to 40V)
LIM: ADDCV OFF	(Stop testing CV + current limit or power limit mode)

Applications with current limiting or power limiting function CV mode operation (Discharging device)

Background

When operating in CC to CV mode, PEL-5000C series at the same time as a Constant Current and constant voltage load, as shown in Fig below.

When operating at constant current (CC) load, PEL-5000C series electronic load to Voltage source (V Batt) Constant Current load (I) and keep Constant Voltage.

When operating at constant voltage load on, the V Batt is greater than V, Input current changes its input voltage is keep fixed.

When the V Batt voltage is less than equal to the set voltage CV, the load does not sink current.

Operation method:

- Load input terminals are connected to the DUT
- Change to CC mode and setting CC current setting.
- Press Limit key to setting the CV voltage and the display will show "Add.CV".
- Press START key to start up the CC+CV test, and press "STOP" key to stop CC+CV test.

CC+CV mode operation application

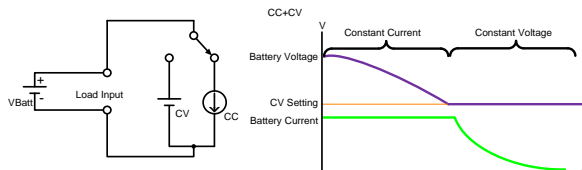

Remote Control CC+CV

REMOTE

(Set Remote Control)

MODE CC

(Setting CC mode)

CC: HIGH 20

(Setting load on current 20A)

LIM: ADDCV:VOLT 50	(Setting constant Voltage is 50V)
LIM: ADDCV ON	(Start testing CC to CV mode)
MEAS: CURR?	(Read current value)
MEAS: VOLT?	(Read voltage value)
LIM: ADDCV: CURR 25	(Modify the current limit point to 25A during the test)
LIM: ADDCV OFF	(Stop testing CC switch to CV mode)

Application with switching from CP mode to CV mode operation (battery discharge)

Background

Operating in CP to CV mode, PEL-5000C series at the same time as a Constant Power and constant Voltage Load, as shown in Fig below.

When Operating at Constant Power (CP) load, PEL-5000C series electronic load provides specified power, independent Constant Voltage source (V Batt) is output voltage.

When Operating at Constant Voltage Load on, the V Batt is greater than V, Input power changes its input voltage is keep fixed.

When the V Batt voltage is less than equal to the set voltage CV, the load does not sink current.

Operation method:

- Load input terminals are connected to the DUT
- Change to CP mode and setting CP power setting.
- Press Limit key to setting the CV voltage and the display will show “Add.CV”.
- Press START key to start up the CP to CV test, and press “STOP” key to stop CP to CV test.

CP+CV mode operation application

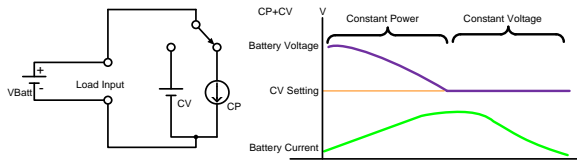

Remote Control CP to CV

- REMOTE (Set Remote Control)
- MODE CP (Setting CP mode)
- CP: HIGH 100 (Setting load on current 100W)
- LIM: ADDCV:VOLT 50 (Setting constant Voltage is 50V)

LIM: ADDCV ON	(start test CP to CV mode)
MEAS: POW?	(Read power value)
MEAS: VOLT?	(Read voltage value)
LIM: ADDCV: POW 2500	(Modify the power limit point to 2500W during the test)
LIM: ADDCV OFF	(Stop test CP to CV mode)

Constant current source operating

Background PEL-5000C high-power electronic load can be used as a constant current source when used in series with a constant voltage source for charging the battery or other applications, as shown in Fig below.

constant current source connection

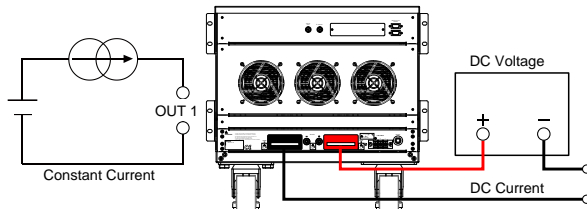

Zero-Volt loading application

Background

As shown in Fig below, the electronic load can be connected in series with a DC voltage source which output voltage greater than minimum operating voltage. so that the device under test that are connected to the electronic load can be operated down to a Zero- Volt condition, the DC voltage source provides the minimum operating voltage required by the Electronic load. This application is suitable for low voltage Battery cell with high discharge current testing.

Zero-Volt loading connection

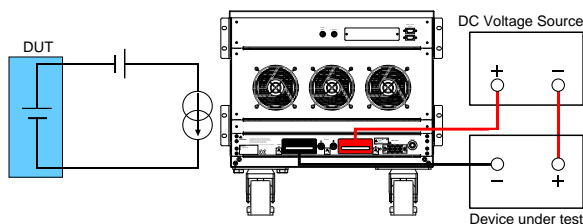

Note

Minimum operating voltage varies according to different models

For model of 150V, Minimum operating voltage is 0.7V

For model of 600V, Minimum operating voltage is 10V

For model of 1200V, Minimum operating voltage is 15V

Parallel operation

Background

It is possible to operate load in parallel if the power and/or current capability of a single PEL-5000C series load is not sufficient.

The positive and negative outputs of the power supply are connected individually to each load module as shown in the Fig below. The setting is made at each individual load module. The total load current is the sum of the load currents being taken by each load.

While in static mode the load modules can be set to operate in CC, CR or CP. When using multiple loads to sink power from a single DC Source it is not permissible to operate in dynamic mode.



Note

- The electronic load only may carry on the parallel operation under the fixed electric current Pattern.
- The electronic load do not use under series connection.

PEL-5000C series
load parallel
operation

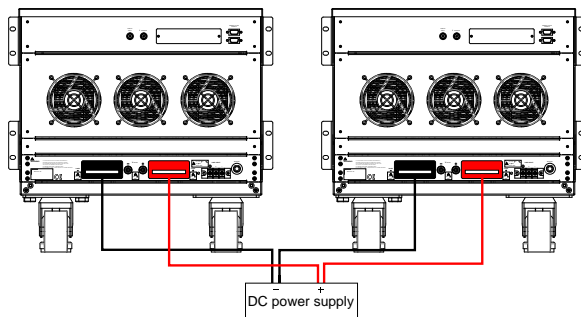

Power Supply OCP testing

OCP Manual control

1. Press Limit key function to setting I_Hi & I_Lo.
2. Setting OCP test, press OCP key to the next step.



3. Setting start load current 0A, press OCP key to the next step.



4. Setting step load current 0.005A, press OCP key to the next step.



5. Setting stop load current 5A, press OCP key to the next step.



6. Setting OCP VTH 6.00V, press OCP key to the next step.



7. Press START/STOP test key.
-

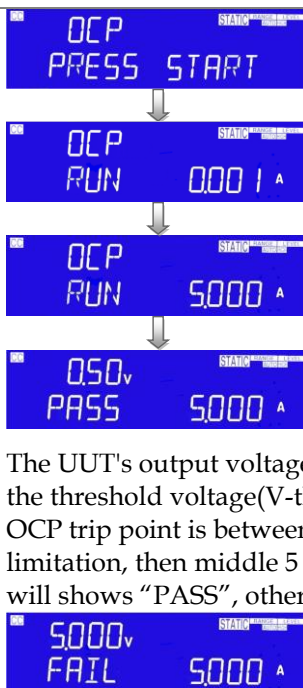

8. The UUT's output voltage drop-out lower than the threshold voltage(V-th setting), and the OCP trip point is between I_Hi and I_Lo limitation, then middle 5 digits LCD display will shows "PASS", otherwise shows "FAIL".

Remote control OCP example

REMOTE	(Set Remote)
TCONFIG OCP	(Set OCP test)
OCP:START 0.1	(Set start load current 0.1A)
OCP:STEP 0.01	(Set step load current 0.01A)
OCP:STOP 2	(Set stop load current 2A)
VTH 3.0	(Set OCP VTH 3.0V)
IL 0	(Set current low limit 0A)
IH 2	(Set current high limit 2A)
NGENABLE ON	(Set NG Enable ON)
START	(Start OCP testing)
TESTING?	(Ask Testing? 1: Testing, 0: Testing End)
NG?	(Ask PASS/FAIL?, 0: PASS, 1: FAIL)
OCP?	(Ask OCP current value)
STOP	(Stop OCP testing)

Power Supply OPP testing

OCP Manual
control

1. Press Limit key function to setting W_Hi & W_Lo.
2. Setting OPP test, press OPP key to the next step.



3. Setting start load current 0W, press OPP key to the next step.



4. Setting step load current 0.5W, press OPP key to the next step.



5. Setting stop load current 100W, press OPP key to the next step.



6. Setting OPP VTH 6.00V, press OPP key to the next step.



7. Press START/STOP test key.
-



8. The UUT's output voltage drop-out lower than the threshold voltage (V-th setting), and the OPP trip point is between W_Hi and W_Lo limitation, then Right 5 digits LCD display will shows "PASS", otherwise shows "FAIL".



Remote control OPP example

REMOTE	(Set Remote)
TCONFIG OPP	(Set OPP test)
OPP:START 3	(Set start load watt 3W)
OPP:STEP 1	(Set step load watt 1W)
OPP:STOP 5	(Set stop load watt 5W)
VTH 3.0	(Set OPP VTH 3.0V)
WL 0	(Set watt low limit 0W)
WH 5	(Set watt high limit 5W)
NGENABLE ON	(Set NG Enable ON)
START	(Start OPP testing)
TESTING?	(Ask Testing? 1: Testing, 0: Testing End)
NG?	(Ask PASS/FAIL?, 0: PASS, 1: FAIL)
OPP?	(Ask OPP watt value)
STOP	(Stop OPP testing)

SHORT testing

- OCP Manual control
1. Setting SHORT test, press Short key to the next step.



2. Press UP key, setting Short time to 10000ms, press Short key to the next Step.



3. Press down key, setting V-Hi voltage to 1.00V, press Short key to the next Step.

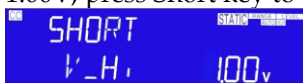

4. Press down key, setting V-Lo voltage to 0V, press Short key to the next step.



5. Press START/STOP test key.



6. Short test finish, the UUT's drop voltage is between V_Hi and V_Lo limitation, then right upper 5 digits LCD display will shows "PASS"



7. The UUT's not drop voltage is between V_Hi and V_Lo limitation, LCD display will shows FAIL.



Remote control SHORT example

REMOTE (Set Remote)

TCONFIG SHORT (Set SHORT test)

STIME 1 (Set short time 1ms)

START (Start SHORT testing)

TESTING? (Ask Testing? 1: Testing, 0: Testing End)

STOP (Stop SHORT testing)

OCP, OPP, SHORT operation flow Chart

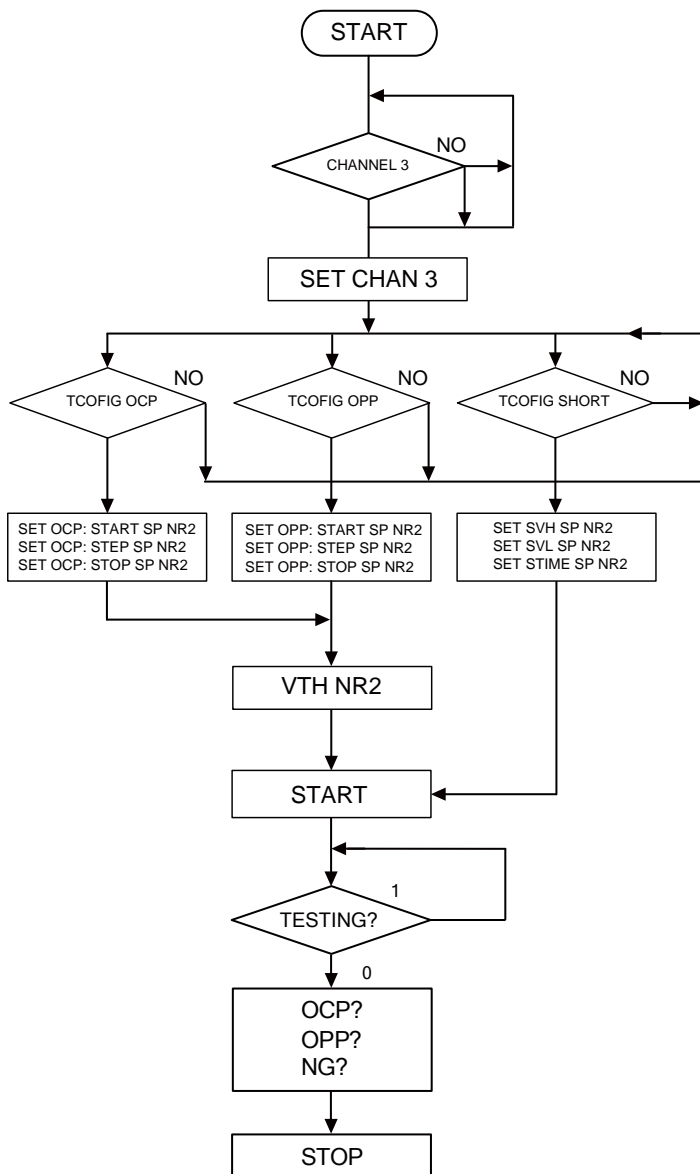

Battery discharge test

There are 6 types battery discharge for the battery discharge application.

Disch CC / Disch CP measure discharge capacity

User option mode CC or CP mode, firstly, Setting UVP(under voltage protect), testing LOAD ON, when battery voltage less than UVP LOAD OFF Display total discharge capacity AH/WH.

Battery Discharge Figure

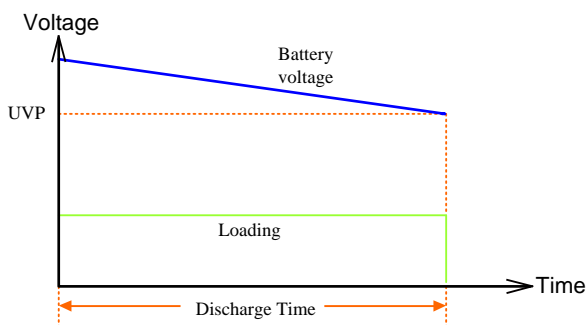

Cycle Life test

Only remote operating, please refer to the remote command list.

Cycle Life test, Battery discharge test use pulse mode, Dynamic mode use count test And Repeat function, as show Fig 5-18, load on and dynamic on until counter to 0, load on and dynamic on auto change to off, Remote will shows "OK" and XX.XXX"(V meter), Cycle setting range 1 to 2000, step setting value 1 to 3 and Repeat setting value 0 to 9999, the setting is by remote operation.



Note

Pre-setting the LOAD OFF voltage can protect the battery from discharging when the preset discharge time has not been reached, and stop the battery when the battery voltage is to low to avoid battery damage.

Cycle Life test
mode Battery
Discharge

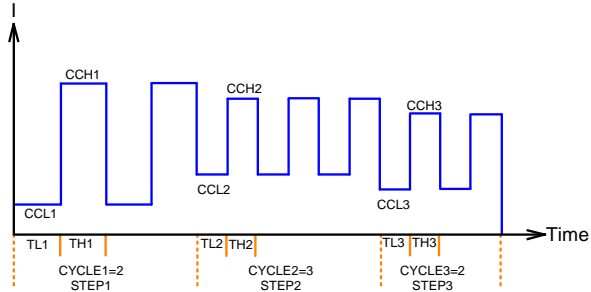

RAMP Mode

RAMP Mode, Slew rate load on and Repeat function, as Fig 5-16 Show. Setting "STEPn" n-1~9, CC0, CC1, ΔT1, CC2, ΔT2.....CC9, ΔT9, Repeat, Load on mode, Increased or Decreased current values by every seconds.

$\Delta CC = (CCn - (CCn-1)) / \text{Time}$, Time: 0~6000Sec, STEP: 1~9, Repeat: 0~9999, Load on auto change to off and remoter will shows "OK" and "XX.XXX" (V meter).



Note

Pre-setting the LOAD OFF voltage can protect the battery from discharging when the preset discharge time has not been reached, and stop the battery when the battery voltage is to low to avoid battery damage.

RAMP Mode
Battery Discharge

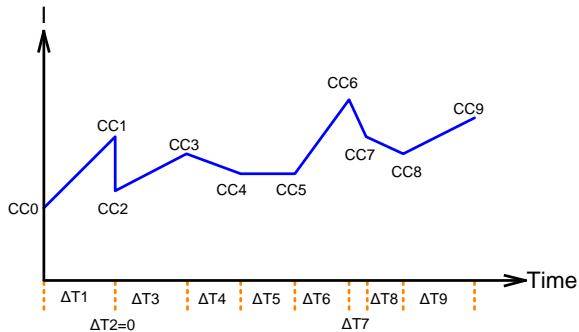

REMOTE Command Description

Disch CC/ Disch CP : Setting BATT: CURR or BATT: POWER, Setting BATT: UVP , setting stop discharge time BATT: TIME, Setting stop discharge capacity BATT: AH or BATT: WH , then "BATT:TEST ON" command start testing , when batty voltage less than UVP value then LOAD OFF, on behalf of the end of the test, When it ends LOAD remote will show "OK,XXXXX", XXXXX representative total discharge capacity : AH/ WH.

Example	When Disch CC	When Disch CP
	BATT: CURR 2.34	BATT: POWER 2.34
	BATT: UVP 12.0	BATT: UVP 12.0
	BATT: TIME 6000	BATT: TIME 6000
	BATT: AH 999	BATT: WH 999
	BATT: TEST ON	BATT: TEST ON

Cycle Life test

Set Cycle Life test, and The set sequence is CCLn/ CCHn/ THn/ TLn/ CYCLEn, Repeat, LDOFFV Parameters command input "BATT: TEST ON ", Command to start the test, Test end, Remote will show "OK, XXXXX", XXXXX is end Voltage.

Example	BATT: CYCLE
	BATT: STEP 2
	BATT: CCH1 6.0
	BATT: CCL1 1.0
	BATT: TH1 2.0
	BATT: TL1 2.0
	BATT: CYCLE1 500
	BATT: CCH2 4.0
	BATT: CCL2 1.0
	BATT: TH1 1.0
	BATT: TL1 1.0
	BATT: CYCLE2 500
	LDOFFV 10.5

BATT: REPEAT 1
BATT: TEST ON

RAMP Mode

Set RAMP Mode, and The setting sequence is CCLn/ CCHn/ THn/ TLn/ CYCLEn, Repeat LDOFFV Parameters command input "BATT: TEST ON", Command to start the test, Test end, Remoter will show "OK, XXXXX", XXXXX is end Voltage.

Example	BATT: RAMP
	BATT: STEP 3
	BATT: CC0 1
	BATT: CC1 3
	BATT: DTIME1 1
	BATT: CC2 6
	BATT: DTIME2 0
	BATT: CC3 4
	BATT: DTIME3 2
	LDOFFV 10.5
	BATT: REPEAT 10
	BATT: TEST ON

APPENDIX

PEL-5000C Default Settings	176
PEL-5000C Dimensions.....	183
PEL-5006C-150-600, PEL-5006C-600-420, PEL-5006C-1200-240	183
PEL-5012C-150-1200, PEL-5012C-600-840, PEL-5012C-1200-480	184
PEL-5018C-150-1800, PEL-5018C-600-1260, PEL-5018C-1200-720	185
PEL-5024C-600-1680, PEL-5024C-1200-960.....	186
PEL-5000C series Specifications	187
PEL-5006C-150-600, PEL-5008C-150-800	187
PEL-5010C-150-1000, PEL-5012C-150-1200.....	189
PEL-5015C-150-1500, PEL-5018C-150-1800.....	190
PEL-5020C-150-2000, PEL-5024C-150-2000.....	192
PEL-5006C-600-420, PEL-5008C-600-560	194
PEL-5010C-600-700, PEL-5012C-600-840.....	196
PEL-5015C-600-1050, PEL-5018C-600-1260.....	197
PEL-5020C-600-1400, PEL-5024C-600-1680.....	199
PEL-5006C-1200-240, PEL-5008C-1200-320.....	201
PEL-5010C-1200-400, PEL-5012C-1200-480.....	203
PEL-5015C-1200-600, PEL-5018C-1200-720.....	204
PEL-5020C-1200-800, PEL-5024C-1200-960.....	206
Certificate Of Compliance.....	209
GPIB programming Example.....	210
PEL-5000C series USB Instruction	214
PEL-5000C series Auto-Sequence function provide EDIT, ENTER, EXIT, TEST and STORE 5 keys operation	216
PEL-5000C series LAN Instruction	220

PEL-5000C Default Settings

The following default settings are the factory configuration settings for the load.

Model	PEL-5006C-150-600	PEL-5008-150-800	PEL-5010C-150-1000
Item	Initial value		
CC L+Preset	0.000 A	0.000 A	0.000 A
CC H+Preset	0.000 A	0.000 A	0.000 A
CR H+Preset	15000Ω	11250Ω	9000.0Ω
CR L+Preset	15000Ω	11250Ω	9000.0Ω
CV H+Preset	150.00 V	150.00 V	150.00 V
CV L+Preset	150.00 V	150.00 V	150.00 V
CP L+Preset	0.00 W	0.0W	0.0W
CP H+Preset	0.00 W	0.0W	0.0W

Model	PEL-5012C-150-1200	PEL-5015C-150-1500	PEL-5018C-150-1800
Item	Initial value		
CC L+Preset	0.000 A	0.000 A	0.000 A
CC H+Preset	0.000 A	0.000 A	0.000 A
CR H+Preset	7500.0Ω	6000.0Ω	5000.0Ω
CR L+Preset	7500.0Ω	6000.0Ω	5000.0Ω
CV H+Preset	150.00 V	150.00 V	150.00 V
CV L+Preset	150.00 V	150.00 V	150.00 V
CP L+Preset	0.00 W	0.0W	0.0W
CP H+Preset	0.00 W	0.0W	0.0W

Model	PEL-5020C-150-2000	PEL-5024C-150-2000	PEL-5006C-600-420
Item	Initial value		
CC L+Preset	0.000 A	0.000 A	0.000 A
CC H+Preset	0.000 A	0.000 A	0.000 A
CR H+Preset	4500.0Ω	4500.0Ω	85712Ω
CR L+Preset	4500.0Ω	4500.0Ω	85712Ω
CV H+Preset	150.00 V	150.00 V	600.00 V
CV L+Preset	150.00 V	150.00 V	600.00 V
CP L+Preset	0.00 W	0.0W	0.0W
CP H+Preset	0.00 W	0.0W	0.0W

Model	PEL-5008C-600-560	PEL-5010C-600-700	PEL-5012C-600-840
Item	Initial value		
CC L+Preset	0.000 A	0.000 A	0.000 A
CC H+Preset	0.000 A	0.000 A	0.000 A

CR H+Preset	64284Ω	51427Ω	42856Ω
CR L+Preset	64284Ω	51427Ω	42856Ω
CV H+Preset	600.00 V	600.00 V	600.00 V
CV L+Preset	600.00 V	600.00 V	600.00 V
CP L+Preset	0.00 W	0.0W	0.0W
CP H+Preset	0.00 W	0.0W	0.0W

Model	PEL-5015C-600-1050	PEL-5018C-600-1260	PEL-5020C-600-1400
Item	Initial value		
CC L+Preset	0.000 A	0.000 A	0.000 A
CC H+Preset	0.000 A	0.000 A	0.000 A
CR H+Preset	34284Ω	28570Ω	25713Ω
CR L+Preset	34284Ω	28570Ω	25713Ω
CV H+Preset	600.00 V	600.00 V	600.00 V
CV L+Preset	600.00 V	600.00 V	600.00 V
CP L+Preset	0.00 W	0.0W	0.0W
CP H+Preset	0.00 W	0.0W	0.0W

Model	PEL-5024C-600-1680	PEL-5006C-1200-240	PEL-5008C-1200-320
Item	Initial value		
CC L+Preset	0.000 A	0.000 A	0.000 A
CC H+Preset	0.000 A	0.000 A	0.000 A
CR H+Preset	21428Ω	30000Ω	22500Ω
CR L+Preset	21428Ω	30000Ω	22500Ω
CV H+Preset	600.00 V	1200.0 V	1000.0 V
CV L+Preset	600.00 V	1200.0 V	1000.0 V
CP L+Preset	0.00 W	0.0W	0.0W
CP H+Preset	0.00 W	0.0W	0.0W

Model	PEL-5010C-1200-400	PEL-5012C-1200-480	PEL-5015C-1200-600
Item	Initial value		
CC L+Preset	0.000 A	0.000 A	0.000 A
CC H+Preset	0.000 A	0.000 A	0.000 A
CR H+Preset	18000Ω	15000Ω	12000Ω
CR L+Preset	18000Ω	15000Ω	12000Ω
CV H+Preset	1200.0 V	1200.0 V	1200.0 V
CV L+Preset	1200.0 V	1200.0 V	1200.0 V
CP L+Preset	0.00 W	0.0W	0.0W
CP H+Preset	0.00 W	0.0W	0.0W

Model	PEL-5018C-1200-720	PEL-5020C-1200-800	PEL-5024C-1200-960
Item	Initial value		
CC L+Preset	0.000 A	0.000 A	0.000 A

CC H+Preset	0.000 A	0.000 A	0.000 A
CR H+Preset	10000Ω	9000Ω	6000Ω
CR L+Preset	10000Ω	9000Ω	6000Ω
CV H+Preset	1000.0 V	1200.0 V	1200.0 V
CV L+Preset	1000.0 V	1200.0 V	1200.0 V
CP L+Preset	0.00 W	0.0W	0.0W
CP H+Preset	0.00 W	0.0W	0.0W

Model	PEL-5006C-150-600	PEL-5008-150-800	PEL-5010C-150-1000
Item	Initial value for Limit		
V_Hi	150.00 V	150.00 V	150.00 V
V_Lo	0.00 V	0.00 V	0.00 V
I_Hi	600.00 A	800.00 A	1000.0 A
I_Lo	0.00 A	0.00 A	0.00 A
W_Hi	6000.0 W	8000.0 W	10000.0 W
W_Lo	0.0 W	0.0 W	0.0 W

Model	PEL-5012C-150-1200	PEL-5015C-150-1500	PEL-5018C-150-1800
Item	Initial value for Limit		
V_Hi	150.00 V	150.00 V	150.00 V
V_Lo	0.00 V	0.00 V	0.00 V
I_Hi	1200.0 A	1200.0 A	1800.0 A
I_Lo	0.00 A	0.00 A	0.00 A
W_Hi	12000.0 W	15000.0 W	18000.0 W
W_Lo	0.0 W	0.0 W	0.0 W

Model	PEL-5020C-150-2000	PEL-5024C-150-2000	PEL-5006C-600-420
Item	Initial value for Limit		
V_Hi	150.00 V	150.00 V	600.00 V
V_Lo	0.00 V	0.00 V	0.00 V
I_Hi	2000.0 A	2000.0 A	420.00 A
I_Lo	0.00 A	0.00 A	0.00 A
W_Hi	20000 W	24000 W	6000.0 W
W_Lo	0.0 W	0.0 W	0.0 W

Model	PEL-5008C-600-560	PEL-5010C-600-700	PEL-5012C-600-840
Item	Initial value for Limit		
V_Hi	600.00 V	600.00 V	600.00 V
V_Lo	0.00 V	0.00 V	0.00 V
I_Hi	560.00 A	700.00 A	840.00 A
I_Lo	0.00 A	0.00 A	0.00 A
W_Hi	8000.0 W	10000.0 W	12000.0 W
W_Lo	0.0 W	0.0 W	0.0 W

Model	PEL-5015C-600-1050	PEL-5018C-600-1260	PEL-5020C-600-1400
Item	Initial value for Limit		
V_Hi	600.00 V	600.00 V	600.00 V
V_Lo	0.00 V	0.00 V	0.00 V
I_Hi	840.00 A	1260.00 A	1400.00 A
I_Lo	0.00 A	0.00 A	0.00 A
W_Hi	15000.0 W	18000.0 W	20000 W
W_Lo	0.0 W	0.0 W	0.0 W

Model	PEL-5024C-600-1680	PEL-5006C-1200-240	PEL-5008C-1200-320
Item	Initial value for Limit		
V_Hi	600.00 V	1200.0 V	1200.0 V
V_Lo	0.00 V	0.00 V	0.00 V
I_Hi	1680.00 A	240.00 A	320.00 A
I_Lo	0.00 A	0.00 A	0.00 A
W_Hi	24000 W	6000.0 W	8000.0 W
W_Lo	0.0 W	0.0 W	0.0 W

Model	PEL-5010C-1200-400	PEL-5012C-1200-480	PEL-5015C-1200-600
Item	Initial value for Limit		
V_Hi	1200.0 V	1000.0 V	1200.0 V
V_Lo	0.00 V	0.00 V	0.00 V
I_Hi	400.00 A	480.00 A	600.00 A
I_Lo	0.00 A	0.00 A	0.00 A
W_Hi	10000.0 W	12000.0 W	15000.0 W
W_Lo	0.0 W	0.0 W	0.0 W

Model	PEL-5018C-1200-720	PEL-5020C-1200-800	PEL-5024C-1200-960
Item	Initial value		
V_Hi	1200.0 V	1200.0 V	1200.0 V
V_Lo	0.00 V	0.00 V	0.00 V
I_Hi	720.00 A	800.00 A	960.00 A
I_Lo	0.00 A	0.00 A	0.00 A
W_Hi	18000.0 W	20000 W	24000 W
W_Lo	0.0 W	0.0 W	0.0 W

Model	PEL-5006C-150-600	PEL-5008-150-800	PEL-5010C-150-1000
Item	Initial value for DYN		
T HI	0.050 mS	0.050 mS	0.050 mS
T LO	0.050 mS	0.050 mS	0.050 mS
RISE	0.144A/μS	0.192A/μS	0.240A/μS
FALL	0.144A/μS	0.192A/μS	0.240A/μS

Model	PEL-5012C-150-1200	PEL-5015C-150-1500	PEL-5018C-150-1800
Item	Initial value for DYN		
T HI	0.050 mS	0.050 mS	0.050 mS
T LO	0.050 mS	0.050 mS	0.050 mS
RISE	0.288A/uS	0.360A/uS	0.432A/uS
FALL	0.288A/uS	0.360A/uS	0.432A/uS

Model	PEL-5020C-150-2000	PEL-5024C-150-2000	PEL-5006C-600-420
Item	Initial value for DYN		
T HI	0.050 mS	0.050 mS	0.050 mS
T LO	0.050 mS	0.050 mS	0.050 mS
RISE	0.480A/uS	0.480A/uS	0.288A/uS
FALL	0.480A/uS	0.480A/uS	0.288A/uS

Model	PEL-5008C-600-560	PEL-5010C-600-700	PEL-5012C-600-840
Item	Initial value for DYN		
T HI	0.050 mS	0.050 mS	0.050 mS
T LO	0.050 mS	0.050 mS	0.050 mS
RISE	0.288A/uS	0.336A/uS	0.384A/uS
FALL	0.288A/uS	0.336A/uS	0.384A/uS

Model	PEL-5015C-600-1050	PEL-5018C-600-1260	PEL-5020C-600-1400
Item	Initial value for DYN		
T HI	0.050 mS	0.050 mS	0.050 mS
T LO	0.050 mS	0.050 mS	0.050 mS
RISE	0.432A/uS	0.480A/uS	0.528A/uS
FALL	0.432A/uS	0.480A/uS	0.528A/uS

Model	PEL-5024C-600-1680	PEL-5006C-1200-240	PEL-5008C-1200-320
Item	Initial value for DYN		
T HI	0.050 mS	0.050 mS	0.050 mS
T LO	0.050 mS	0.050 mS	0.050 mS
RISE	0.576A/uS	0.192A/uS	0.192A/uS
FALL	0.576A/uS	0.192A/uS	0.192A/uS

Model	PEL-5010C-1200-400	PEL-5012C-1200-480	PEL-5015C-1200-600
Item	Initial value for DYN		
T HI	0.050 mS	0.050 mS	0.050 mS
T LO	0.050 mS	0.050 mS	0.050 mS
RISE	0.224A/uS	0.256A/uS	0.288A/uS
FALL	0.224A/uS	0.256A/uS	0.288A/uS

Model	PEL-5018C-1200-720	PEL-5020C-1200-800	PEL-5024C-1200-960
Item	Initial value for DYN		
T HI	0.050 mS	0.050 mS	0.050 mS
T LO	0.050 mS	0.050 mS	0.050 mS
RISE	0.320A/μS	0.352A/μS	0.384A/μS
FALL	0.320A/μS	0.352A/μS	0.384A/μS

Model	PEL-5006C-150-600	PEL-5008-150-800	PEL-5010C-150-1000
Item	Initial value for CONFIG		
SENSE	Auto	Auto	Auto
LD-ON	2.50 V	2.50 V	2.50 V
LD-OFF	1.000V	1.000V	1.000V
+LOAD	+LOAD	+LOAD	+LOAD

Model	PEL-5012C-150-1200	PEL-5015C-150-1500	PEL-5018C-150-1800
Item	Initial value for CONFIG		
SENSE	Auto	Auto	Auto
LD-ON	2.50 V	2.50 V	2.50 V
LD-OFF	1.000V	1.000V	1.000V
+LOAD	+LOAD	+LOAD	+LOAD

Model	PEL-5020C-150-2000	PEL-5024C-150-2000	PEL-5006C-600-420
Item	Initial value for CONFIG		
SENSE	Auto	Auto	Auto
LD-ON	2.50 V	2.50 V	4.00 V
LD-OFF	1.000V	1.000V	0.50 V
+LOAD	+LOAD	+LOAD	+LOAD

Model	PEL-5008C-600-560	PEL-5010C-600-700	PEL-5012C-600-840
Item	Initial value for CONFIG		
SENSE	Auto	Auto	Auto
LD-ON	4.00 V	4.00 V	4.00 V
LD-OFF	0.50 V	0.50 V	0.50 V
+LOAD	+LOAD	+LOAD	+LOAD

Model	PEL-5015C-600-1050	PEL-5018C-600-1260	PEL-5020C-600-1400
Item	Initial value for DYN		
SENSE	Auto	Auto	Auto
LD-ON	4.00 V	4.00 V	4.00 V
LD-OFF	0.50 V	0.50 V	0.50 V
+LOAD	+LOAD	+LOAD	+LOAD

Model	PEL-5024C-600-1680	PEL-5006C-1200-240	PEL-5008C-1200-320
Item	Initial value for DYN		
SENSE	Auto	Auto	Auto
LD-ON	4.00 V	10.00 V	10.00 V
LD-OFF	0.50 V	5.00 V	5.00 V
+LOAD	+LOAD	+LOAD	+LOAD

Model	PEL-5010C-1200-400	PEL-5012C-1200-480	PEL-5015C-1200-600
Item	Initial value for DYN		
SENSE	Auto	Auto	Auto
LD-ON	10.00 V	10.00 V	10.00 V
LD-OFF	5.00 V	5.00 V	5.00 V
+LOAD	+LOAD	+LOAD	+LOAD

Model	PEL-5018C-1200-720	PEL-5020C-1200-800	PEL-5024C-1200-960
Item	Initial value for DYN		
SENSE	Auto	Auto	Auto
LD-ON	10.00 V	10.00 V	10.00 V
LD-OFF	5.00 V	5.00 V	5.00 V
+LOAD	+LOAD	+LOAD	+LOAD

Model	All model
Item	Initial value
SHORT	Disable
OPP	Disable
OCP	Disable

PEL-5000C Dimensions

PEL-5006C-150-600, PEL-5006C-600-420, PEL-5006C-1200-240

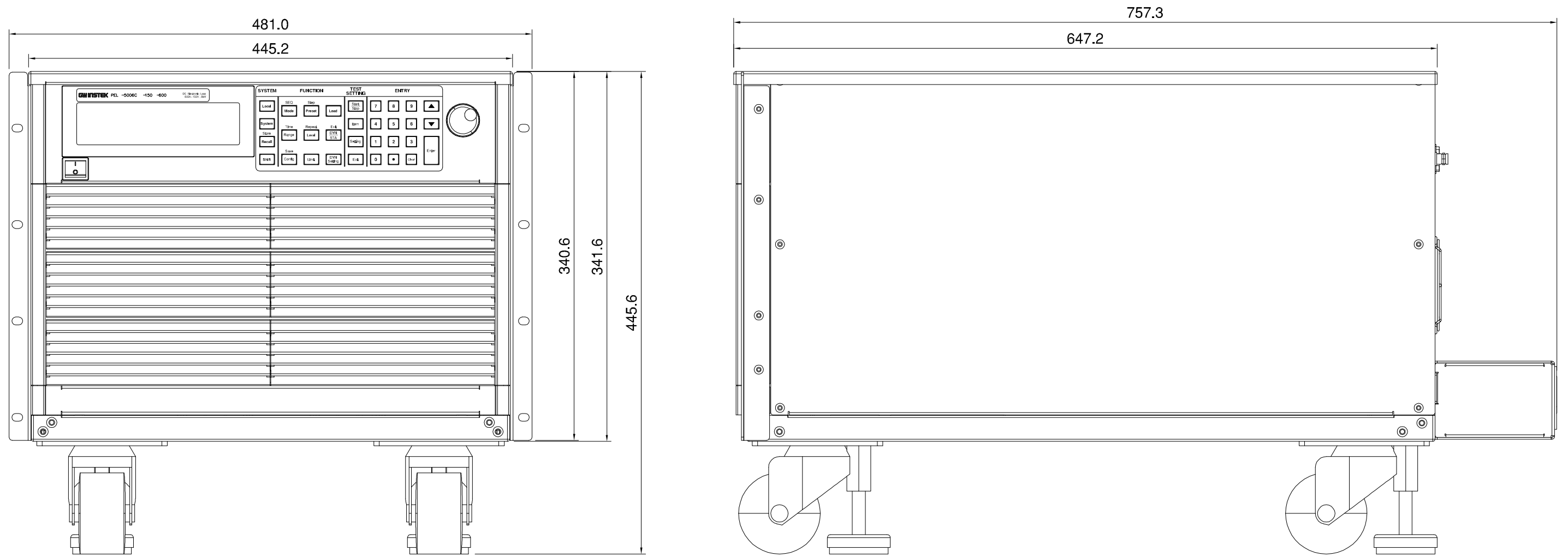

PEL-5012C-150-1200, PEL-5012C-600-840, PEL-5012C-1200-480

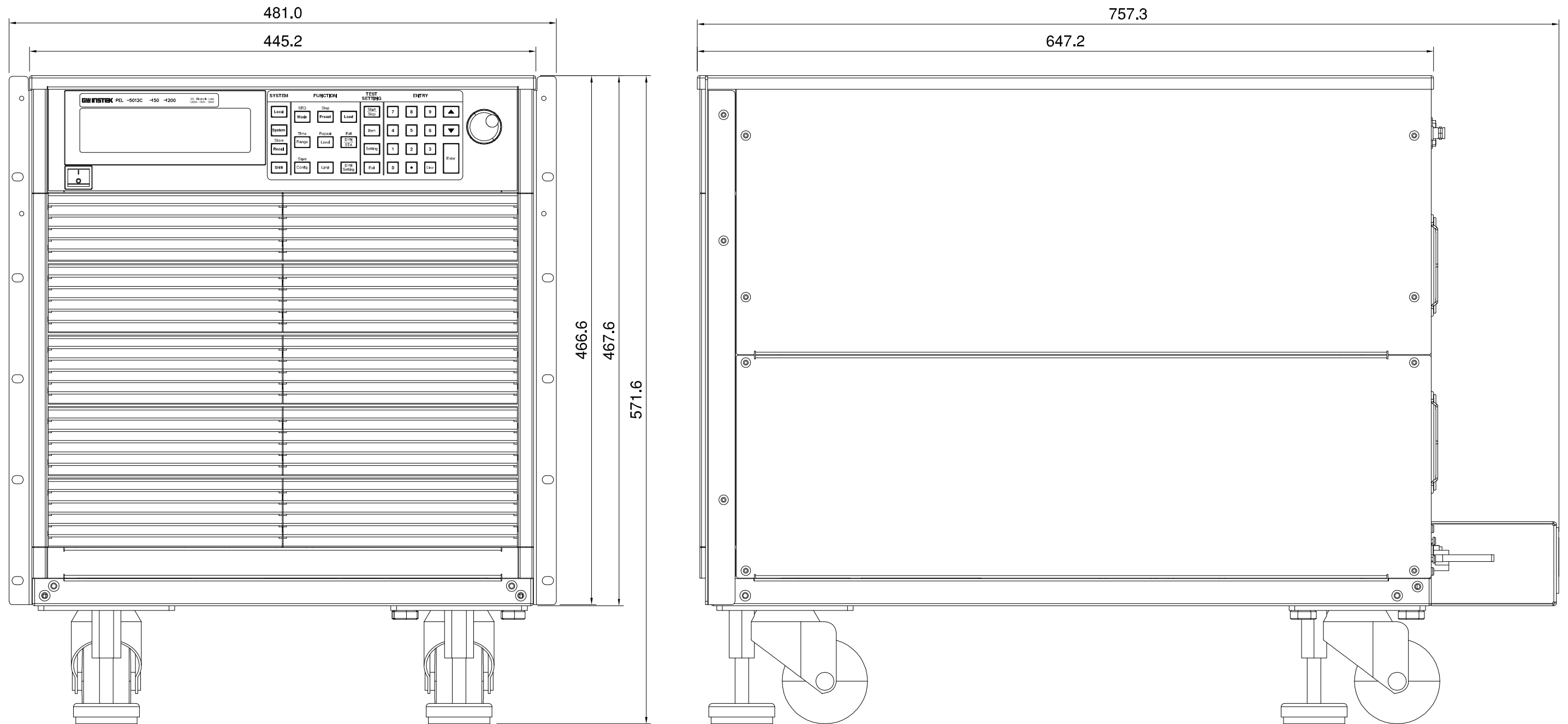

PEL-5018C-150-1800, PEL-5018C-600-1260, PEL-5018C-1200-720

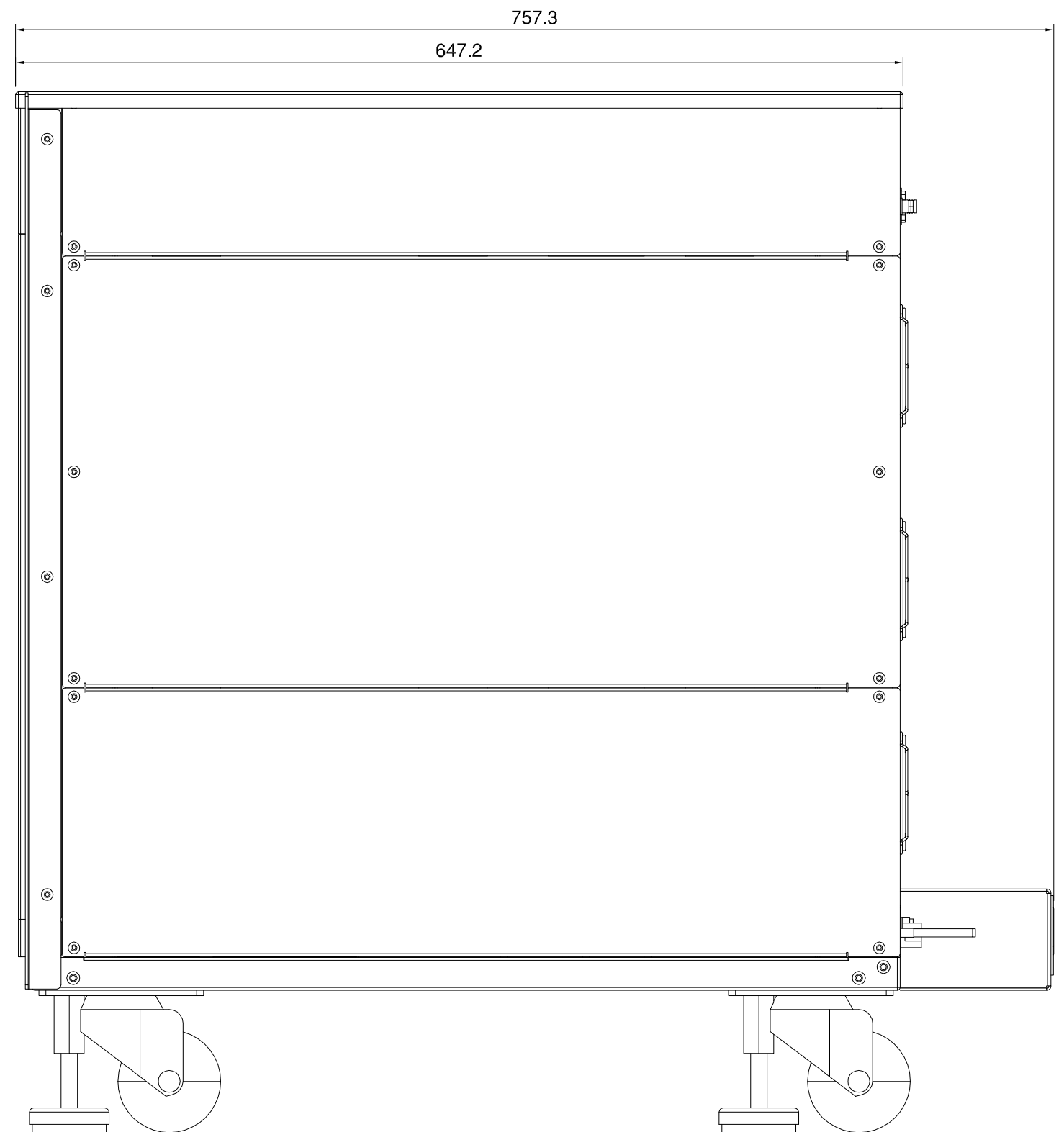
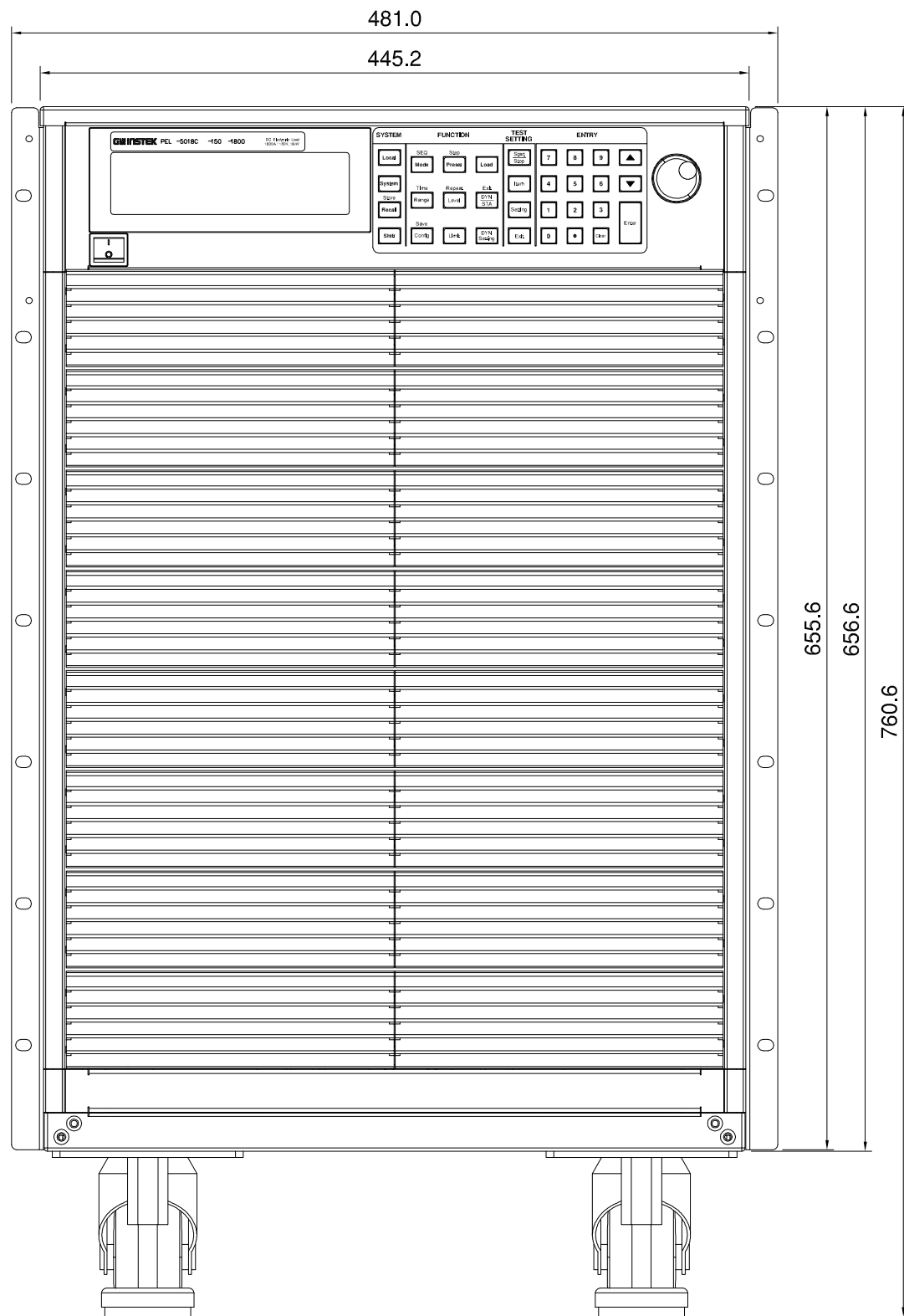

PEL-5024C-600-1680, PEL-5024C-1200-960

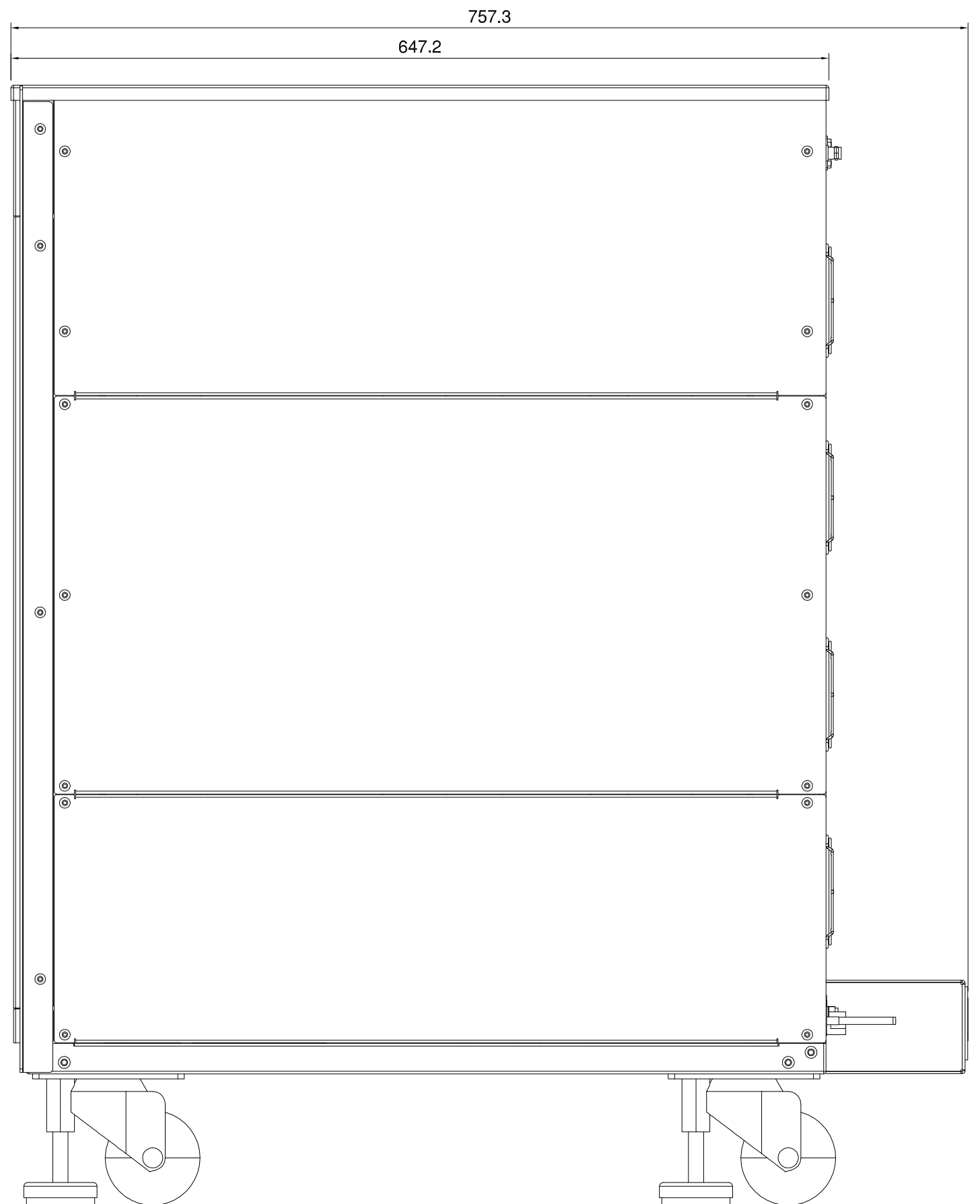
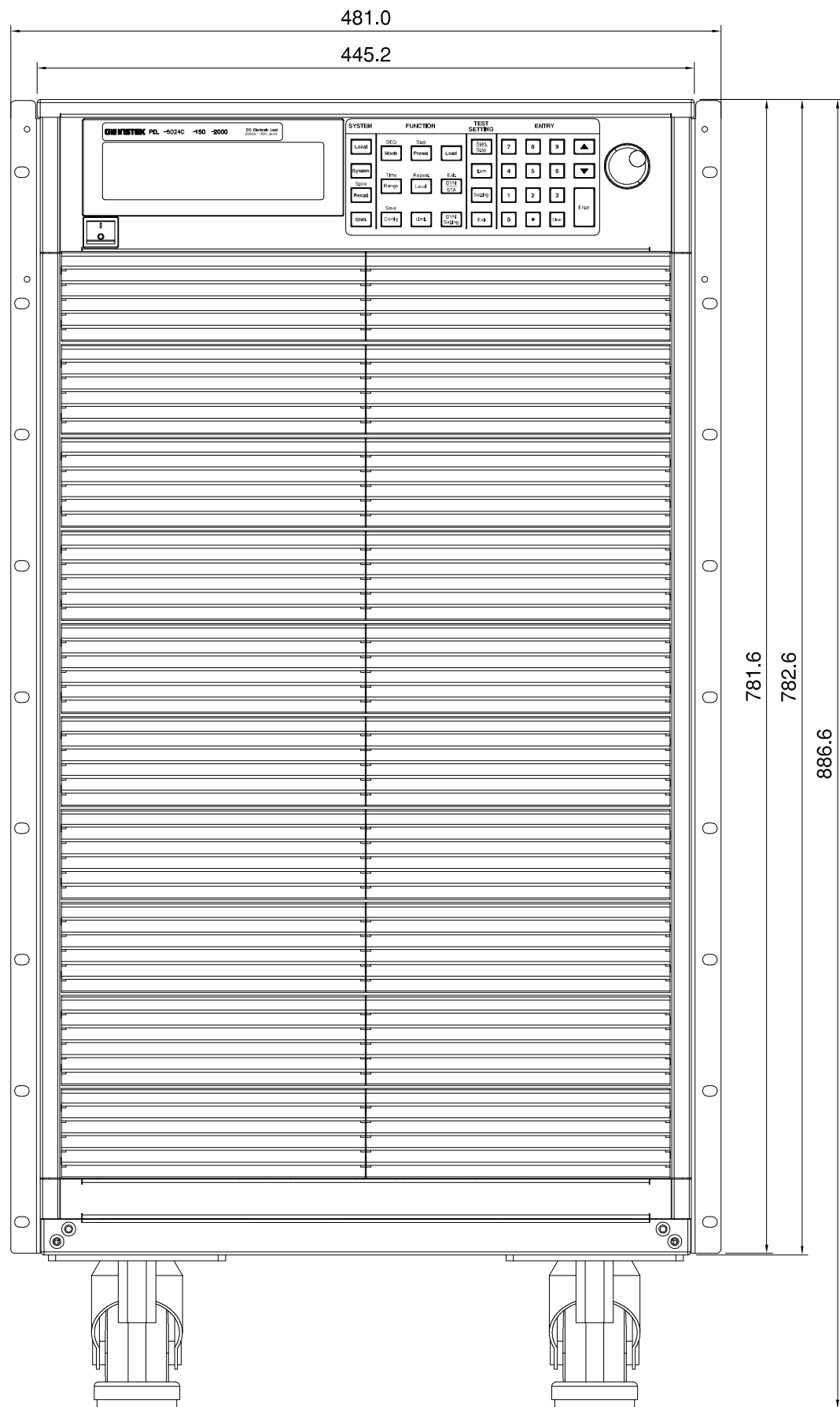

PEL-5000C series Specifications

The specifications apply when the PEL-5000C is powered on for at least 30 minutes. Note that the high frequency and high voltage options are listed as separate specifications.

PEL-5006C-150-600, PEL-5008C-150-800

Model	PEL-5006C-150-600		PEL-5008C-150-800	
Power* ¹	6KW		8KW	
Current	0 ~ 60A	0 ~ 600A	0 ~ 80A	0 ~ 800A
Voltage	0 ~ 150V			
Min. Operating Voltage	0.7V@600A		0.7V@800A	
Protections				
Over Power Protection(OPP)	105%			
Over Current Protection(OCP)	104%			
Over Voltage Protection(OVP)	105%			
Over Temp Protection(OTP)	90°C±5°C			
Constant Current Mode				
Range* ²	60A	600A	80A	800A
Resolution	0.96mA	9.6mA	1.28mA	12.8mA
Accuracy* ³	± 0.05% of (Setting + Range)			
Constant Resistance Mode				
Range	15000Ω ~ 0.25Ω	0.25Ω ~ 0.0012Ω	11250Ω~ 0.1875Ω	0.1875Ω~ 0.0009Ω
Resolution	66.666μS	4.167μΩ	88.888μS	3.125μΩ
Accuracy	± 0.2% of (Setting + Range)			
Constant Voltage Mode				
Range	150V			
Resolution	2.5mV			
Accuracy	± 0.05% of (Setting + Range)			
Constant Power Mode				
Range	600W	6000W	800W	8000W
Resolution	9.6mW	96mW	12.8mW	128mW
Accuracy	± 0.1% of (Setting + Range)			
Constant Voltage Mode + Constant Current Mode				
Range	150V	600A	150V	800A
Resolution	2.5mV	9.6mA	2.5mV	12.8mA
Accuracy	± 1.0% of (Setting + Range)			
Constant Voltage Mode + Constant Power Mode				
Range	150V	6000W	150V	8000W
Resolution	2.5mV	96mW	2.5mV	128mW
Accuracy	± 1.0% of (Setting + Range)			
Surge Test				
Surge & Normal current	0~600A		0~800A	
Surge time	10~1000ms			
Surge step	1~5			

MPPT Mode				
Algorithm	P & O			
Load mode	CV			
P&O interval	1000ms~60000ms ; resolution 1000ms			
Dynamic Mode				
Timing				
Thigh & Tlow	0.010~9.999 / 99.99 / 999.9 / 9999ms			
Resolution	0.001 / 0.01 / 0.1 / 1mS			
Accuracy	1μS/10μS/100μS/1mS + 50ppm			
Slew rate	0.0144A~ 0.9A/μS 0.144A ~ 9A/μS 0.0192A~ 1.2A/μS 0.192A ~ 12A/μS			
Resolution	0.0036A/μS 0.036A/μS 0.0048A/μS 0.048A/μS			
Min. Rise Time	66.7μS (typical)			
Accuracy	± (5% of Setting) ±10μS			
Current				
Range	0 ~ 60A	60 ~ 600A	0 ~ 80A	80 ~ 800A
Resolution	0.96mA	9.6mA	1.28mA	12.8mA
Measurement				
Voltage Read Back				
Range (5 Digital)	0 ~ 15V	15 ~ 150V	0 ~ 15V	15 ~ 150V
Resolution	0.25mV	2.5mV	0.25mV	2.5mV
Accuracy	± 0.025% of (Reading + Range)			
Current Read Back				
Range (5 Digital)	0 ~ 60A	60 ~ 600A	0 ~ 80A	80 ~ 800A
Resolution	0.96mA	9.6mA	1.28mA	12.8mA
Accuracy	± 0.05% of (Reading + Range)			
Power Read Back				
Range (5 Digital)	6000W		8000W	
Accuracy ^{*4}	± 0.06% of (Reading + Range)			
General				
Typical Short Resistance	0.0012Ω		0.0009Ω	
Maximum Short Current	600A		800A	
Load ON Voltage	0.25 ~ 62.5V			
Load OFF Voltage	0 ~ 62.5V			
Power Consumption	510VA		920VA	
Dimension(H x W x D)	445.6mm x 481mm x 757.3mm		571.6mm x 481mm x 757.3mm	
Dimension(H x W x D) (Not included Rack Mount Kit)	445.6mm x 445.2mm x 757.3mm		571.6mm x 445.2mm x 757.3mm	
Dimension(H x W x D) (Not included Rack Mount Kit, wheels)	341.6mm x 445.2mm x 757.3mm		467.6mm x 445.2mm x 757.3mm	
Weight	62KG		77.5KG	
Temperature ^{*5}	0~40°C			
Safety & EMC	CE			

PEL-5010C-150-1000, PEL-5012C-150-1200

Model	PEL-5010C-150-1000		PEL-5012C-150-1200	
Power*1	10KW		12KW	
Current	0 ~ 100A	0 ~ 1000A	0 ~ 120A	0 ~ 1200A
Voltage	0 ~ 150V			
Min. Operating Voltage	0.7V@1000A		0.7V@1200A	
Protections				
Over Power Protection(OPP)	105%			
Over Current Protection(OCP)	104%			
Over Voltage Protection(OVP)	105%			
Over Temp Protection(OTP)	90°C±5°C			
Constant Current Mode				
Range*2	100A	1000A	120A	1200A
Resolution	1.6mA	16mA	1.92mA	19.2mA
Accuracy*3	± 0.05% of (Setting + Range)			
Constant Resistance Mode				
Range	9000Ω~ 0.15Ω	0.15Ω~ 0.0007Ω	7500Ω~ 0.125Ω	0.125Ω~ 0.0006Ω
Resolution	111.111μS	2.5μΩ	133.333μS	2.084μΩ
Accuracy	± 0.2% of (Setting + Range)			
Constant Voltage Mode				
Range	150V			
Resolution	2.5mV			
Accuracy	± 0.05% of (Setting + Range)			
Constant Power Mode				
Range	1000W	10000W	1200W	12000W
Resolution	16mW	160mW	19.2mW	192mW
Accuracy	± 0.1% of (Setting + Range)			
Constant Voltage Mode + Constant Current Mode				
Range	150V	1000A	150V	1200A
Resolution	2.5mV	3.2mA	2.5mV	19.2mA
Accuracy	± 1.0% of (Setting + Range)			
Constant Voltage Mode + Constant Power Mode				
Range	150V	10000W	150V	12000W
Resolution	2.5mV	160mW	2.5mV	192mW
Accuracy	± 1.0% of (Setting + Range)			
Surge Test				
Surge & Normal current	0~1000A		0~1200A	
Surge time	10~1000ms			
Surge step	1~5			
MPPT Mode				
Algorithm	P & O			
Load mode	CV			
P&O interval	1000ms~6000ms ; resolution 1000ms			
Dynamic Mode				
Timing				
Thigh & Tlow	0.010~9.999 / 99.99 / 999.9 / 9999mS			
Resolution	0.001 / 0.01 / 0.1 / 1mS			

Accuracy	1μS/10μS/100μS/1mS + 50ppm			
Slew rate	0.024A~1.5A/μS	0.24A~15A/μS	0.0288A~1.8A/μS	0.288A~18A/μS
Resolution	0.006A/μS	0.06A/μS	0.0072A/μS	0.072A/μS
Min. Rise Time	66.7μS(typical)			
Accuracy	± (5% of Setting) ±10μS			
Current				
Range	0 ~ 100A	100 ~ 1000A	0 ~ 120A	120 ~ 1200A
Resolution	1.6mA	16mA	1.92mA	19.2mA
Measurement				
Voltage Read Back				
Range (5 Digital)	0 ~ 15V	15 ~ 150V	0 ~ 15V	15 ~ 150V
Resolution	0.25mV	2.5mV	0.25mV	2.5mV
Accuracy	± 0.025% of (Reading + Range)			
Current Read Back				
Range (5 Digital)	0~100A	100 ~ 1000A	0 ~ 120A	120 ~ 1200A
Resolution	1.6mA	16mA	1.92mA	19.2mA
Accuracy	± 0.05% of (Reading + Range)			
Power Read Back				
Range (5 Digital)	10000W		12000W	
Accuracy ^{*4}	± 0.06% of (Reading + Range)			
General				
Typical Short Resistance	0.0007Ω		0.0006Ω	
Maximum Short Current	1000A		1200A	
Load ON Voltage	0.25 ~ 62.5V			
Load OFF Voltage	0 ~ 62.5V			
Power Consumption	920VA			
Dimension(H x W x D)	571.6mm x 481mm x 757.3mm			
Dimension(H x W x D) (Not included Rack Mount Kit)	571.6mm x 445.2mm x 757.3mm			
Dimension(H x W x D) (Not included Rack Mount Kit, wheels)	467.6mm x 445.2mm x 757.3mm			
Weight	84.8KG		92KG	
Temperature ^{*5}	0~40°C			
Safety & EMC	CE			

PEL-5015C-150-1500, PEL-5018C-150-1800

Model	PEL-5015C-150-1500		PEL-5018C-150-1800	
Power ^{*1}	15KW		18KW	
Current	0 ~ 150A	0 ~ 1500A	0 ~ 180A	0 ~ 1800A
Voltage	0 ~ 150V			
Min. Operating Voltage	0.7V@1500A		0.7V@1800A	
Protections				
Over Power Protection(OPP)	105%			
Over Current Protection(OCP)	104%			
Over Voltage Protection(OVP)	105%			
Over Temp Protection(OTP)	90°C±5°C			

Constant Current Mode				
Range ^{*2}	150A	1500A	180A	1800A
Resolution	2.4mA	24mA	2.88mA	28.8mA
Accuracy ^{*3}	± 0.05% of (Setting + Range)			
Constant Resistance Mode				
Range	6000Ω~ 0.1Ω	0.1Ω~ 0.0005Ω	5000Ω~0.0833Ω	0.0833Ω~0.0004Ω
Resolution	166.666μS	1.667μΩ	200μS	1.389μΩ
Accuracy	± 0.2% of (Setting + Range)			
Constant Voltage Mode				
Range	150V			
Resolution	2.5mV			
Accuracy	± 0.05% of (Setting + Range)			
Constant Power Mode				
Range	1500W	15000W	1800W	18000W
Resolution	24mW	240mW	2.88mW	288mW
Accuracy	± 0.1% of (Setting + Range)			
Constant Voltage Mode + Constant Current Mode				
Range	150V	1500A	150V	1800A
Resolution	2.5mV	24mA	2.5mV	28.8mA
Accuracy	± 1.0% of (Setting + Range)			
Constant Voltage Mode + Constant Power Mode				
Range	150V	15000W	150V	18000W
Resolution	2.5mV	240mW	2.5mV	288mW
Accuracy	± 1.0% of (Setting + Range)			
Surge Test				
Surge & Normal current	0~1500A		0~1800A	
Surge time	10~1000ms			
Surge step	1~5			
MPPT Mode				
Algorithm	P & O			
Load mode	CV			
P&O interval	1000ms~60000ms ; resolution 1000ms			
Dynamic Mode				
Timing				
Thigh & Tlow	0.010~9.999 / 99.99 / 999.9 / 9999mS			
Resolution	0.001 / 0.01 / 0.1 / 1mS			
Accuracy	1μS/10μS/100μS/1mS + 50ppm			
Slew rate	0.036A~2.25A/μS	0.360A~22.5A/μS	0.0432A ~ 2.7A/μS	0.432A ~ 27A/μS
Resolution	0.009A/μS	0.09A/μS	0.0108A/μS	0.108A/μS
Min. Rise Time	66.7μS (typical)			
Accuracy	± (5% of Setting) ±10μS			
Current				
Range	0 ~ 150A	150 ~ 1500A	0 ~ 180A	180 ~ 1800A
Resolution	2.4mA	24mA	2.88mA	28.8mA
Measurement				
Voltage Read Back				
Range (5 Digital)	0 ~ 15V	15 ~ 150V	0 ~ 15V	15 ~ 150V
Resolution	0.25mV	2.5mV	0.25mV	2.5mV
Accuracy	± 0.025% of (Reading + Range)			

Current Read Back				
Range (5 Digital)	0 ~ 150A	150 ~ 1500A	0 ~ 180A	180 ~ 1800A
Resolution	2.4mA	24mA	2.88mA	28.8mA
Accuracy	± 0.05% of (Reading + Range)			
Power Read Back				
Range (5 Digital)	15000W		18000W	
Accuracy*4	± 0.06% of (Reading + Range)			
General				
Typical Short Resistance	0.0005Ω		0.0004Ω	
Maximum Short Current	1500A		1800A	
Load ON Voltage	0.25 ~ 62.5V			
Load OFF Voltage	0 ~ 62.5V			
Power Consumption	1320VA			
Dimension(H x W x D)	760.6mm x 481mm x 757.3mm			
Dimension(H x W x D) (Not included Rack Mount Kit)	760.6mm x 445.2mm x 757.3mm			
Dimension(H x W x D) (Not included Rack Mount Kit, wheels)	656.6mm x 445.2mm x 757.3mm			
Weight	116.5KG		124KG	
Temperature *5	0~40°C			
Safety & EMC	CE			

PEL-5020C-150-2000, PEL-5024C-150-2000

Model	PEL-5020C-150-2000		PEL-5024C-150-2000	
Power*1	20KW		24KW	
Current	0 ~ 200A	0 ~ 2000A	0 ~ 200A	0 ~ 2000A
Voltage	0 ~ 150V			
Min. Operating Voltage	0.7V@2000A			
Protections				
Over Power Protection(OPP)	105%			
Over Current Protection(OCP)	104%			
Over Voltage Protection(OVP)	105%			
Over Temp Protection(OTP)	90°C±5°C			
Constant Current Mode				
Range*2	200A	2000A	200A	2000A
Resolution	3.2mA	32mA	3.2mA	32mA
Accuracy*3	± 0.05% of (Setting + Range)			
Constant Resistance Mode				
Range	4500Ω~ 0.075Ω	0.075Ω~ 0.0004Ω	4500Ω~ 0.075Ω	0.075Ω~ 0.0004Ω
Resolution	222.22μS	1.25μΩ	222.22μS	1.25μΩ
Accuracy	± 0.2% of (Setting + Range)			
Constant Voltage Mode				
Range	150V			
Resolution	2.5mV			
Accuracy	± 0.05% of (Setting + Range)			

Constant Power Mode				
Range	2000W	20000W	2400W	24000W
Resolution	32mW	320mW	38.4mW	384mW
Accuracy	± 0.1% of (Setting + Range)			
Constant Voltage Mode + Constant Current Mode				
Range	150V	2000A	150V	2000A
Resolution	2.5mV	32mA	2.5mV	32mA
Accuracy	± 1.0% of (Setting + Range)			
Constant Voltage Mode + Constant Power Mode				
Range	150V	20000W	150V	24000W
Resolution	2.5mV	320mW	2.5mV	384mW
Accuracy	± 1.0% of (Setting + Range)			
Surge Test				
Surge & Normal current	0~2000A			
Surge time	10~1000ms			
Surge step	1~5			
MPPT Mode				
Algorithm	P & O			
Load mode	CV			
P&O interval	1000ms~6000ms ; resolution 1000ms			
Dynamic Mode				
Timing				
High & Tlow	0.010~9.999 / 99.99 / 999.9 / 9999mS			
Resolution	0.001 / 0.01 / 0.1 / 1mS			
Accuracy	1μS/10μS/100μS/1mS + 50ppm			
Slew rate	0.048A ~ 3A/μS	0.48A ~ 30A/μS	0.048A ~ 3A/μS	0.48A ~ 30A/μS
Resolution	0.012A/μS	0.12A/μS	0.012A/μS	0.12A/μS
Min. Rise Time	66.7μS (typical)			
Accuracy	± (5% of Setting) ±10μS			
Current				
Range	0 ~ 200A	200 ~ 2000A	0 ~ 200A	200 ~ 2000A
Resolution	3.2mA	32mA	3.2mA	32mA
Measurement				
Voltage Read Back				
Range (5 Digital)	0 ~ 15V	15 ~ 150V	0 ~ 15V	15 ~ 150V
Resolution	0.25mV	2.5mV	0.25mV	2.5mV
Accuracy	± 0.025% of (Reading + Range)			
Current Read Back				
Range (5 Digital)	0 ~ 200A	200 ~ 2000A	0 ~ 200A	200 ~ 2000A
Resolution	3.2mA	32mA	3.2mA	32mA
Accuracy	± 0.05% of (Reading + Range)			
Power Read Back				
Range (5 Digital)	20000W		24000W	
Accuracy ^{*4}	± 0.06% of (Reading + Range)			
General				
Typical Short Resistance	0.0004Ω			
Maximum Short Current	2000A			
Load ON Voltage	0.25 ~ 62.5V			
Load OFF Voltage	0 ~ 62.5V			
Power Consumption	1700VA			

Dimension(H x W x D)	886.6mm x 481mm x 757.3mm	
Dimension(H x W x D)	(Not included Rack Mount Kit) 886.6mm x 445.2mm x 757.3m	
Dimension(H x W x D)	(Not included Rack Mount Kit, wheels) 782.6mm x 445.2mm x 757.3mm	
Weight	140.5KG	155KG
Temperature *5	0~40°C	
Safety & EMC	CE	

PEL-5006C-600-420, PEL-5008C-600-560

Model	PEL-5006C-600-420		PEL-5008C-600-560	
Power*1	6KW		8KW	
Current	0 ~ 42A	0 ~420A	0 ~ 56A	0 ~ 560A
Voltage	0 ~ 600V			
Min. Operating Voltage	10V@420A		10V@560A	
Protections				
Over Power Protection(OPP)	105%			
Over Current Protection(OCP)	104%			
Over Voltage Protection(OVP)	105%			
Over Temp Protection(OTP)	90°C±5°C			
Constant Current Mode				
Range*2	42A	420A	56A	560A
Resolution	0.672mA	6.72mA	0.896mA	8.96mA
Accuracy*3	± 0.05% of (Setting + Range)			
Constant Resistance Mode				
Range	85712Ω~ 1.42853Ω	1.42853Ω~ 0.02384Ω	64284Ω~ 1.0714Ω	1.0714Ω~ 0.01788Ω
Resolution	11.6669μS	23.84μΩ	15.5559μS	17.88μΩ
Accuracy	± 0.2% of (Setting + Range)			
Constant Voltage Mode				
Range	600V			
Resolution	10mV			
Accuracy	± 0.05% of (Setting + Range)			
Constant Power Mode				
Range	6000W	6000W	8000W	8000W
Resolution	9.6mW	96mW	12.8mW	128mW
Accuracy	± 0.2% of (Setting + Range)	± 0.1% of (Setting + Range)	± 0.2% of (Setting + Range)	± 0.1% of (Setting + Range)
Constant Voltage Mode + Constant Current Mode				
Range	600V	420A	600V	560A
Resolution	10mV	6.72mA	10mV	8.96mA
Accuracy	± 1.0% of (Setting + Range)			
Constant Voltage Mode + Constant Power Mode				
Range	600V	6000W	600V	8000W
Resolution	10mV	96mW	10mV	128mW
Accuracy	± 1.0% of (Setting + Range)			

Surge Test				
Surge & Normal current	0–420A		0–560A	
Surge time	10–1000ms			
Surge step	1–5			
MPPT Mode				
Algorithm	P & O			
Load mode	CV			
P&O interval	1000ms–60000ms ; resolution 1000ms			
Dynamic Mode				
Timing				
Thigh & Tlow	0.010–9.999 / 99.99 / 999.9 / 9999ms			
Resolution	0.001 / 0.01 / 0.1 / 1ms			
Accuracy	1 μ S/10 μ S/100 μ S/1ms + 50ppm			
Slew rate	0.0288A ~ 1.8A/ μ S 0.288A ~ 18A/ μ S 0.0288A ~ 1.8A/ μ S 0.288A ~ 18A/ μ S			
Resolution	0.0072A/ μ S	0.072A/ μ S	0.0072A/ μ S	0.072A/ μ S
Min. Rise Time	66.7 μ S (typical)			
Accuracy	\pm (5% of Setting) \pm 10 μ S			
Current				
Range	0 ~ 42A	42 ~ 420A	0 ~ 56A	56 ~ 560A
Resolution	0.672mA	6.72mA	0.896mA	8.96mA
Measurement				
Voltage Read Back				
Range (5 Digital)	0 ~ 60V	60 ~ 600V	0 ~ 60V	60 ~ 600V
Resolution	1mV	10mV	1mV	10mV
Accuracy	\pm 0.025% of (Reading + Range)			
Current Read Back				
Range (5 Digital)	0 ~ 42A	42 ~ 420A	0 ~ 56A	56 ~ 560A
Resolution	0.672mA	6.72mA	0.896mA	8.96mA
Accuracy	\pm 0.05% of (Reading + Range)			
Power Read Back				
Range (5 Digital)	6000W		8000W	
Accuracy ^{*4}	\pm 0.06% of (Reading + Range)			
General				
Typical Short Resistance	0.0239 Ω		0.0179 Ω	
Maximum Short Current	420A		560A	
Load ON Voltage	0.4 ~ 100V			
Load OFF Voltage	0 ~ 100V			
Power Consumption	510VA		920VA	
Dimension (H x W x D)	445.6mm x 481mm x 757.3mm		571.6mm x 481mm x 757.3mm	
Dimension (H x W x D) (Not included Rack Mount Kit)	445.6mm x 445.2mm x 757.3mm		571.6mm x 445.2mm x 757.3mm	
Dimension (H x W x D) (Not included Rack Mount Kit, wheels)	341.6mm x 445.2mm x 757.3mm		467.6mm x 445.2mm x 757.3mm	
Weight	62KG		77.5KG	
Temperature ^{*5}	0–40°C			
Safety & EMC	CE			

PEL-5010C-600-700, PEL-5012C-600-840

Model	PEL-5010C-600-700		PEL-5012C-600-840	
Power*1	10KW		12KW	
Current	0 ~ 70A	0 ~ 700A	0 ~ 84A	0 ~ 840A
Voltage	0 ~ 600V			
Min. Operating Voltage	10V@700A		10V@840A	
Protections				
Over Power Protection(OPP)	105%			
Over Current Protection(OCP)	104%			
Over Voltage Protection(OVP)	105%			
Over Temp Protection(OTP)	90°C±5°C			
Constant Current Mode				
Range*2	70A	700A	84A	840A
Resolution	1.12mA	11.2mA	1.344mA	13.44mA
Accuracy*3	± 0.05% of (Setting + Range)			
Constant Resistance Mode				
Range	51427.2Ω~	0.85712Ω~	42856Ω~	0.714267Ω~
	0.85712Ω	0.014304Ω	0.714267Ω	0.01192Ω
Resolution	19.4449μS	14.304μΩ	23.3339μS	11.92μΩ
Accuracy	± 0.2% of (Setting + Range)			
Constant Voltage Mode				
Range	600V			
Resolution	10mV			
Accuracy	± 0.05% of (Setting + Range)			
Constant Power Mode				
Range	1000W	10000W	1200W	12000W
Resolution	16mW	160mW	19.2mW	192mW
Accuracy	± 0.2% of (Setting + Range)	± 0.1% of (Setting + Range)	± 0.2% of (Setting + Range)	± 0.1% of (Setting + Range)
Constant Voltage Mode + Constant Current Mode				
Range	600V	700A	600V	840A
Resolution	10mV	11.2mA	10mV	13.44mA
Accuracy	± 1.0% of (Setting + Range)			
Constant Voltage Mode + Constant Power Mode				
Range	600V	10000W	600V	12000W
Resolution	10mV	160mW	10mV	192mW
Accuracy	± 1.0% of (Setting + Range)			
Surge Test				
Surge & Normal current	0~700A		0~840A	
Surge time	10~1000ms			
Surge step	1~5			
MPPT Mode				
Algorithm	P & O			
Load mode	CV			
P&O interval	1000ms~60000ms ; resolution 1000ms			

Dynamic Mode				
Timing				
Thigh & Tlow	0.010~9.999 / 99.99 / 999.9 / 9999mS			
Resolution	0.001 / 0.01 / 0.1 / 1mS			
Accuracy	1μS/10μS/100μS/1mS + 50ppm			
Slew rate	0.0336A ~	0.336A ~ 21A/μS	0.0384A ~	0.384A ~ 24A/μS
	2.1A/μS		2.4A/μS	
Resolution	0.0084A/μS	0.084A/μS	0.0096A/μS	0.096A/μS
Accuracy	± (5% of Setting) ±10μS			
Current				
Range	0 ~ 70A	70 ~ 700A	0 ~ 84A	84 ~ 840A
Resolution	1.12mA	11.2mA	1.334mA	13.34mA
Measurement				
Voltage Read Back				
Range (5 Digital)	0 ~ 60V	60 ~ 600V	0 ~ 60V	60 ~ 600V
Resolution	1mV	10mV	1mV	10mV
Accuracy	± 0.025% of (Reading + Range)			
Current Read Back				
Range (5 Digital)	0 ~ 70A	70 ~ 700A	0 ~ 84A	84 ~ 840A
Resolution	1.12mA	11.2mA	1.334mA	13.34mA
Accuracy	± 0.05% of (Reading + Range)			
Power Read Back				
Range (5 Digital)	10000W		12000W	
Accuracy *4	± 0.06% of (Reading + Range)			
General				
Typical Short Resistance	0.0143Ω		0.00120Ω	
Maximum Short Current	700A		840A	
Load ON Voltage	0.4 ~ 100V			
Load OFF Voltage	0 ~ 100V			
Power Consumption	920VA			
Dimension(H x W x D)	571.6mm x 481mm x 757.3mm			
Dimension(H x W x D) (Not included Rack Mount Kit)	571.6mm x 445.2mm x 757.3mm			
Dimension(H x W x D) (Not included Rack Mount Kit, wheels)	467.6mm x 445.2mm x 757.3mm			
Weight	84.8KG		92KG	
Temperature *5	0~40°C			
Safety & EMC	CE			

PEL-5015C-600-1050, PEL-5018C-600-1260

Model	PEL-5015C-600-1050		PEL-5018C-600-1260	
Power*1	15KW		18KW	
Current	0 ~ 105A	0 ~ 1050A	0 ~ 126A	0 ~ 1260A
Voltage	0 ~ 600V			
Min. Operating Voltage	10V@1050A		10V@1260A	

Protections

Over Power Protection(OPP) 105%
 Over Current 104%
 Protection(OCP)
 Over Voltage Protection(OVP) 105%
 Over Temp Protection(OTP) 90°C±5°C

Constant Current Mode

Range*2	105A	1050A	126A	1260A
Resolution	1.68mA	16.8mA	2.016mA	20.16mA
Accuracy*3	± 0.05% of (Setting + Range)			

Constant Resistance Mode

Range	34284.8 ~ 0.571413Ω	0.571413~ 0.009536Ω	28570.67Ω~ 0.476178Ω	0.476178Ω~ 0.007947Ω
Resolution	29.1674μS	9.536μΩ	35.0009μS	7.947μΩ
Accuracy	± 0.2% of (Setting + Range)			

Constant Voltage Mode

Range	600V
Resolution	10mV
Accuracy	± 0.05% of (Setting + Range)

Constant Power Mode

Range	1500W	15000W	1800W	18000W
Resolution	24mW	240mW	28.8mW	288mW
Accuracy	± 0.2% of (Setting + Range)	± 0.1% of (Setting + Range)	± 0.2% of (Setting + Range)	± 0.1% of (Setting + Range)

Constant Voltage Mode + Constant Current Mode

Range	600V	1050A	600V	1260A
Resolution	10mV	16.8mA	10mV	20.16mA
Accuracy	± 1.0% of (Setting + Range)			

Constant Voltage Mode + Constant Power Mode

Range	600V	15000W	600V	18000W
Resolution	10mV	240mW	10mV	288mW
Accuracy	± 1.0% of (Setting + Range)			

Surge Test

Surge & Normal current	0~1050A	0~1260A
Surge time	10~1000ms	
Surge step	1~5	

MPPT Mode

Algorithm	P & O
Load mode	CV
P&O interval	1000ms~6000ms ; resolution 1000ms

Dynamic Mode

Timing	
Thigh & Tlow	0.010~9.999 / 99.99 / 999.9 / 9999mS
Resolution	0.001 / 0.01 / 0.1 / 1mS
Accuracy	1μS/10μS/100μS/1mS + 50ppm
Slew rate	0.0432A ~ 2.7A/μS 0.432A ~ 27A/μS 0.048A ~ 3A/μS 0.48A ~ 30A/μS
Resolution	0.0108A/μS 0.108A/μS 0.012A/μS 0.12A/μS
Accuracy	± (5% of Setting) ± 10μS

Current				
Range	0 ~ 105A	105 ~ 1050A	0 ~ 126A	126 ~ 1260A
Resolution	1.68mA	16.8mA	2.016mA	20.16mA
Measurement				
Voltage Read Back				
Range (5 Digital)	0 ~ 60V	60 ~ 600V	0 ~ 60V	60 ~ 600V
Resolution	1mV	10mV	1mV	10mV
Accuracy	± 0.025% of (Reading + Range)			
Current Read Back				
Range (5 Digital)	0 ~ 105A	105 ~ 1050A	0 ~ 126A	126 ~ 1260A
Resolution	1.68mA	16.8mA	2.016mA	20.16mA
Accuracy	± 0.05% of (Reading + Range)			
Power Read Back				
Range (5 Digital)	15000W		18000W	
Accuracy *4	± 0.06% of (Reading + Range)			
General				
Typical Short Resistance	0.0096Ω		0.0080Ω	
Maximum Short Current	1050A		1260A	
Load ON Voltage	0.4 ~ 100V			
Load OFF Voltage	0 ~ 100V			
Power Consumption	1320VA			
Dimension (H x W x D)	760.6mm x 481mm x 757.3mm			
Dimension (H x W x D) (Not included Rack Mount Kit)	760.6mm x 445.2mm x 757.3mm			
Dimension (H x W x D) (Not included Rack Mount Kit, wheels)	656.6mm x 445.2mm x 757.3mm			
Weight	116.5KG		124KG	
Temperature*5	0~40°C			
Safety & EMC	CE			

PEL-5020C-600-1400, PEL-5024C-600-1680

Model	PEL-5020C-600-1400		PEL-5024C-600-1680	
Power*1	20KW		24KW	
Current	0 ~ 140A	0 ~ 1400A	0 ~ 168A	0 ~ 1680A
Voltage	0 ~ 600V			
Min. Operating Voltage	10V@1400A		10V@1680A	
Protections				
Over Power Protection (OPP)	105%			
Over Current Protection (OCP)	104%			
Over Voltage Protection (OVP)	105%			
Over Temp Protection (OTP)	90°C±5°C			
Constant Current Mode				
Range*2	140A	1400A	168A	1680A
Resolution	2.24mA	22.4mA	2.688mA	26.88mA
Accuracy*3	± 0.05% of (Setting + Range)			

Constant Resistance Mode				
Range	25713.6Ω~ 0.42856Ω	0.42856Ω~ 0.007152Ω	21428 ~ 0.357133Ω	0.357133Ω~ 0.00596Ω
Resolution	38.8899μS	7.152μΩ	46.6679μS	5.96μΩ
Accuracy	± 0.2% of (Setting + Range)			
Constant Voltage Mode				
Range	600V			
Resolution	10mV			
Accuracy	± 0.05% of (Setting + Range)			
Constant Power Mode				
Range	2000W	20000W	2400W	24000W
Resolution	32mW	320mW	38.4mW	384mW
Accuracy	± 0.2% of (Setting + Range)	± 0.1% of (Setting + Range)	± 0.2% of (Setting + Range)	± 0.1% of (Setting + Range)
Constant Voltage Mode + Constant Current Mode				
Range	600V	1400A	600V	1680A
Resolution	10mV	22.4mA	10mV	26.88mA
Accuracy	± 1.0% of (Setting + Range)			
Constant Voltage Mode + Constant Power Mode				
Range	600V	20000W	600V	24000W
Resolution	10mV	320mW	10mV	384mW
Accuracy	± 1.0% of (Setting + Range)			
Surge Test				
Surge & Normal current	0~1400A		0~1680A	
Surge time	10~1000ms			
Surge step	1~5			
MPPT Mode				
Algorithm	P & O			
Load mode	CV			
P&O interval	1000ms~60000ms ; resolution 1000ms			
Dynamic Mode				
Timing				
Thigh & Tlow	0.010~9.999 / 99.99 / 999.9 / 9999mS			
Resolution	0.001 / 0.01 / 0.1 / 1mS			
Accuracy	1μS/10μS/100μS/1mS + 50ppm			
Slew rate	0.0528A ~ 3.3A/μS 0.528A ~ 33A/μS 0.0576A ~ 3.6A/μS 0.576A ~ 36A/μS			
Resolution	0.0132A/μS	0.132A/μS	0.0144A/μS	0.144A/μS
Accuracy	± (5% of Setting) ±10μS			
Current				
Range	0 ~ 140A	140 ~ 1400A	0 ~ 168A	168 ~ 1680A
Resolution	2.24mA	22.4mA	2.688mA	26.88mA
Measurement				
Voltage Read Back				
Range (5 Digital)	0 ~ 60V	60 ~ 600V	0 ~ 60V	60 ~ 600V
Resolution	1mV	10mV	1mV	10mV
Accuracy	± 0.025% of (Reading + Range)			
Current Read Back				
Range (5 Digital)	0 ~ 140A	140 ~ 1400A	0 ~ 168A	168 ~ 1680A
Resolution	2.24mA	22.4mA	2.688mA	26.88mA

Accuracy	± 0.05% of (Reading + Range)	
Power Read Back		
Range (5 Digital)	20000W	24000W
Accuracy ^{*4}	± 0.06% of (Reading + Range)	
General		
Typical Short Resistance	0.0072Ω	0.0060Ω
Maximum Short Current	1400A	1680A
Load ON Voltage	0.4 ~ 100V	
Load OFF Voltage	0 ~ 100V	
Power Consumption	1700VA	
Dimension(H x W x D)	886.6mm x 481mm x 757.3mm	
Dimension(H x W x D) (Not included Rack Mount Kit)	886.6mm x 445.2mm x 757.3m	
Dimension(H x W x D) (Not included Rack Mount Kit, wheels)	782.6mm x 445.2mm x 757.3mm	
Weight	140.5KG	155KG
Temperature ^{*5}	0~40°C	
Safety & EMC	CE	

PEL-5006C-1200-240, PEL-5008C-1200-320

Model	PEL-5006C-1200-240		PEL-5008C-1200-320	
Power ^{*1}	6KW		8KW	
Current	0 ~ 24A	0 ~240A	0 ~ 32A	0 ~ 320A
Voltage	0 ~ 1200V			
Min. Operating Voltage	15V@240A		15V@320A	
Protections				
Over Power Protection (OPP)	105%			
Over Current Protection (OCP)	104%			
Over Voltage Protection (OVP)	105%			
Over Temp Protection (OTP)	90°C±5°C			
Constant Current Mode				
Range ^{*2}	24A	240A	32A	320A
Resolution	0.384mA	3.84mA	0.512mA	5.12mA
Accuracy ^{*3}	± 0.05% of (Setting + Range)			
Constant Resistance Mode				
Range	30kΩ~ 5Ω	5Ω~ 0.0625Ω	22.5kΩ~ 3.75Ω	3.75Ω~ 0.0469Ω
Resolution	3.333μS	83.334μΩ	4.444μS	62.5μΩ
Accuracy	± 0.2% of (Setting + Range)			
Constant Voltage Mode				
Range	1200V			
Resolution	20mV			
Accuracy	± 0.05% of (Setting + Range)			
Constant Power Mode				
Range	600W	6000W	800W	8000W
Resolution	9.6mW	96mW	12.8mW	128mW

Accuracy*6	± 0.1% of (Setting + Range)			
Constant Voltage Mode + Constant Current Mode				
Range	1200V	240A	1200V	320A
Resolution	20mV	3.84mA	20mV	5.12mA
Accuracy	± 1.0% of (Setting + Range)			
Constant Voltage Mode + Constant Power Mode				
Range	1200V	6000W	1200V	8000W
Resolution	20mV	96mW	20mV	128mW
Accuracy	± 1.0% of (Setting + Range)			
Surge Test				
Surge & Normal current	0~240A		0~320A	
Surge time	10~1000ms			
Surge step	1~5			
MPPT Mode				
Algorithm	P & O			
Load mode	CV			
P&O interval	1000ms~60000ms ; resolution 1000ms			
Dynamic Mode				
Timing				
Thigh & Tlow	0.010~9.999 / 99.99 / 999.9 / 9999mS			
Resolution	0.001 / 0.01 / 0.1 / 1mS			
Accuracy	1μS/10μS/100μS/1mS + 50ppm			
Slew rate	0.0192A ~ 1.2A/μS		0.0192A ~ 1.2A/μS	0.0192A ~ 1.2A/μS
Resolution	0.0048A/μS	0.048A/μS	0.0048A/μS	0.048A/μS
Accuracy	± (5% of Setting) ±10μS			
Current				
Range	0 ~ 24A	24 ~ 240A	0 ~ 32A	32 ~ 320A
Resolution	0.384mA	3.84mA	0.512mA	5.12mA
Measurement				
Voltage Read Back				
Range (5 Digital)	0 ~ 120V	120 ~ 1200V	0 ~ 120V	120 ~ 1200V
Resolution	2mV	20mV	2mV	20mV
Accuracy	± 0.025% of (Reading + Range)			
Current Read Back				
Range (5 Digital)	0 ~ 24A	24 ~ 240A	0 ~ 32A	32 ~ 320A
Resolution	0.384mA	3.84mA	0.512mA	5.12mA
Accuracy	± 0.05% of (Reading + Range)			
Power Read Back				
Range (5 Digital)	6000W		8000W	
Accuracy*4	± 0.06% of (Reading + Range)			
General				
Typical Short Resistance	0.0625Ω		0.0469Ω	
Maximum Short Current	240A		320A	
Load ON Voltage	1 ~ 250V			
Load OFF Voltage	0 ~ 250V			
Power Consumption	510VA		920VA	
Dimension(H x W x D)	445.6mm x 481mm x 757.3mm		571.6mm x 481mm x 757.3mm	
Dimension(H x W x D) (Not included Rack)	445.6mm x 445.2mm x 757.3mm		571.6mm x 445.2mm x 757.3mm	

Mount Kit)

Dimension(H x W x D)

(Not included Rack 341.6mm x 445.2mm x 757.3mm 467.6mm x 445.2mm x 757.3mm

Mount Kit, wheels)

Weight 62KG 77.5KG

Temperature*5 0~40°C

Safety & EMC CE

PEL-5010C-1200-400, PEL-5012C-1200-480

Model	PEL-5010C-1200-400		PEL-5012C-1200-480	
Power*1	10KW		12KW	
Current	0 ~ 40A	0 ~ 400A	0 ~ 48A	0 ~ 480A
Voltage	0 ~ 1200V			
Min. Operating Voltage	15V@400A		15V@480A	
Protections				
Over Power Protection(OPP)	105%			
Over Current Protection(OCP)	104%			
Over Voltage Protection(OVP)	105%			
Over Temp Protection(OTP)	90°C±5°C			
Constant Current Mode				
Range*2	40A	400A	48A	480A
Resolution	0.64mA	6.4mA	0.768mA	7.68mA
Accuracy*3	± 0.05% of (Setting + Range)			
Constant Resistance Mode				
Range	18KΩ ~ 3Ω	3Ω ~ 0.0375Ω	15KΩ ~ 2.5Ω	2.5Ω~ 0.0313Ω
Resolution	5.5555μS	50μΩ	6.6666μS	41.667μΩ
Accuracy	± 0.2% of (Setting + Range)			
Constant Voltage Mode				
Range	1200V		1200V	
Resolution	20mV		20mV	
Accuracy	± 0.05% of (Setting + Range)			
Constant Power Mode				
Range	1000W	10000W	1200W	12000W
Resolution	16mW	160mW	19.2mW	192mW
Accuracy*6	± 0.1% of (Setting + Range)			
Constant Voltage Mode + Constant Current Mode				
Range	1200V	400A	1200V	480A
Resolution	20mV	6.4mA	20mV	7.68mA
Accuracy	± 1.0% of (Setting + Range)			
Constant Voltage Mode + Constant Power Mode				
Range	1200V	10000W	1200V	12000W
Resolution	20mV	160mW	20mV	192mW
Accuracy	± 1.0% of (Setting + Range)			
Surge Test				
Surge & Normal current	0~400A		0~480A	
Surge time	10~1000ms			
Surge step	1~5			

MPPT Mode				
Algorithm	P & O			
Load mode	CV			
P&O interval	1000ms~60000ms ; resolution 1000ms			
Dynamic Mode				
Timing				
Thigh & Tlow	0.010~9.999 / 99.99 / 999.9 / 9999mS			
Resolution	0.001 / 0.01 / 0.1 / 1mS			
Accuracy	1μS/10μS/100μS/1mS + 50ppm			
Slew rate	0.0224A ~ 1.4A/μS 0.224A ~ 14A/μS 0.0256A ~ 1.6A/μS 0.256A ~ 16A/μS			
Resolution	0.0056A/μS	0.056A/μS	0.0064A/μS	0.064A/μS
Accuracy	± (5% of Setting) ±10μS			
Current				
Range	0 ~ 40A	40 ~ 400A	0 ~ 48A	48 ~ 480A
Resolution	0.64mA	6.4mA	0.768mA	7.68mA
Measurement				
Voltage Read Back				
Range (5 Digital)	0 ~ 120V	120 ~ 1200V	0 ~ 120V	120 ~ 1200V
Resolution	2mV	20mV	2mV	20mV
Accuracy	± 0.025% of (Reading + Range)			
Current Read Back				
Range (5 Digital)	0 ~ 40A	40 ~ 400A	0 ~ 48A	48 ~ 480A
Resolution	0.64mA	6.4mA	0.768mA	7.68mA
Accuracy	± 0.05% of (Reading + Range)			
Power Read Back				
Range (5 Digital)	10000W		12000W	
Accuracy ^{*4}	± 0.06% of (Reading + Range)			
General				
Typical Short Resistance	0.0375Ω		0.0313Ω	
Maximum Short Current	400A		480A	
Load ON Voltage	1 ~ 250V			
Load OFF Voltage	0 ~ 250V			
Power Consumption	920VA			
Dimension(H x W x D)	571.6mm x 481mm x 757.3mm			
Dimension(H x W x D) (Not included Rack Mount Kit)	571.6mm x 445.2mm x 757.3mm			
Dimension(H x W x D) (Not included Rack Mount Kit, wheels)	467.6mm x 445.2mm x 757.3mm			
Weight	84.8KG		92KG	
Temperature ^{*5}	0~40°C			
Safety & EMC	CE			

PEL-5015C-1200-600, PEL-5018C-1200-720

Model	PEL-5015C-1200-600		PEL-5018C-1200-720	
Power ^{*1}	15KW		18KW	
Current	0 ~ 60A	0 ~ 600A	0 ~ 72A	0 ~ 720A

Voltage	0 ~ 1200V			
Min. Operating Voltage	15V@600A		15V@720A	
Protections				
Over Power Protection(OPP)	105%			
Over Current Protection(OCP)	104%			
Over Voltage Protection(OVP)	105%			
Over Temp Protection(OTP)	90°C±5°C			
Constant Current Mode				
Range ^{*2}	60A	600A	72A	720A
Resolution	0.96mA	9.6mA	1.152mA	11.52mA
Accuracy ^{*3}	± 0.05% of (Setting + Range)			
Constant Resistance Mode				
Range	12KΩ ~ 2Ω	2Ω ~ 0.0250Ω	10KΩ~ 1.666Ω	1.666Ω~ 0.0209Ω
Resolution	8.3333μS	33.334μΩ	10μS	27.77μΩ
Accuracy	± 0.2% of (Setting + Range)			
Constant Voltage Mode				
Range	1200V			
Resolution	20mV			
Accuracy	± 0.05% of (Setting + Range)			
Constant Power Mode				
Range	1500W	15000W	1800W	18000W
Resolution	24mW	240mW	28.8mW	288mW
Accuracy ^{*6}	± 0.1% of (Setting + Range)			
Constant Voltage Mode + Constant Current Mode				
Range	1200V	600A	1200V	720A
Resolution	20mV	9.6mA	20mV	3.2mA
Accuracy	± 1.0% of (Setting + Range)			
Constant Voltage Mode + Constant Power Mode				
Range	1200V	15000W	1200V	18000W
Resolution	20mV	240mW	20mV	288mW
Accuracy	± 1.0% of (Setting + Range)			
Surge Test				
Surge & Normal current	0~600A		0~720A	
Surge time	10~1000ms			
Surge step	1~5			
MPPT Mode				
Algorithm	P & O			
Load mode	CV			
P&O interval	1000ms~60000ms ; resolution 1000ms			
Dynamic Mode				
Timing				
Thigh & Tlow	0.010~9.999 / 99.99 / 999.9 / 9999ms			
Resolution	0.001 / 0.01 / 0.1 / 1mS			
Accuracy	1μS/10μS/100μS/1mS + 50ppm			
Slew rate	0.0288A ~ 1.8A/μS	0.288A ~ 18A/μS	0.032A ~ 2A/μS	0.32A ~ 20A/μS
Resolution	0.0072A/μS	0.072A/μS	0.008A/μS	0.08A/μS
Accuracy	± (5% of Setting) ±10μS			
Current				
Range	0 ~ 60A	60 ~ 600A	0 ~ 72A	72 ~ 720A

Resolution	0.96mA	9.6mA	1.152mA	11.52mA
Measurement				
Voltage Read Back				
Range (5 Digital)	0 ~ 120V	120 ~ 1200V	0 ~ 120V	120 ~ 1200V
Resolution	2mV	20mV	2mV	20mV
Accuracy	± 0.025% of (Reading + Range)			
Current Read Back				
Range (5 Digital)	0 ~ 60A	60 ~ 600A	0 ~ 72A	72 ~ 720A
Resolution	0.96mA	9.6mA	1.152mA	11.52mA
Accuracy	± 0.05% of (Reading + Range)			
Power Read Back				
Range (5 Digital)	15000W		18000W	
Accuracy*4	± 0.06% of (Reading + Range)			
General				
Typical Short Resistance	0.0250Ω		0.0209Ω	
Maximum Short Current	600A		720A	
Load ON Voltage	1 ~ 250V			
Load OFF Voltage	0 ~ 250V			
Power Consumption	1320VA			
Dimension(H x W x D)	760.6mm x 481mm x 757.3mm			
Dimension(H x W x D) (Not included Rack Mount Kit)	760.6mm x 445.2mm x 757.3mm			
Dimension(H x W x D) (Not included Rack Mount Kit, wheels)	656.6mm x 445.2mm x 757.3mm			
Weight	116.5KG		124KG	
Temperature*5	0~40°C			
Safety & EMC	CE			

PEL-5020C-1200-800, PEL-5024C-1200-960

Model	PEL-5020C-1200-800		PEL-5024C-1200-960	
Power*1	20KW		24KW	
Current	0 ~ 80A	0 ~ 800A	0 ~ 96A	0 ~ 960A
Voltage	0 ~ 1200V			
Min. Operating Voltage	15V@800A		15V@960A	
Protections				
Over Power Protection(OPP)	105%			
Over Current Protection(OCP)	104%			
Over Voltage Protection(OVP)	105%			
Over Temp Protection(OTP)	90°C±5°C			
Constant Current Mode				
Range*2	80A	800A	96A	960A
Resolution	1.28mA	12.8mA	1.536mA	15.36mA
Accuracy*3	± 0.05% of (Setting + Range)			
Constant Resistance Mode				
Range	9KΩ ~ 1.5Ω	1.5Ω ~ 0.0187Ω	7.5KΩ ~ 1.25Ω	1.25Ω ~ 0.0156Ω
Resolution	11.111μS	25μΩ	13.333μS	20.834μΩ

Accuracy	± 0.2% of (Setting + Range)			
Constant Voltage Mode				
Range	1200V		1200V	
Resolution	20mV		20mV	
Accuracy	± 0.05% of (Setting + Range)			
Constant Power Mode				
Range	2000W	20000W	2400W	24000W
Resolution	32mW	320mW	38.4mW	384mW
Accuracy ⁶	± 0.1% of (Setting + Range)			
Constant Voltage Mode + Constant Current Mode				
Range	1200V	800A	1200V	960A
Resolution	20mV	3.84mA	20mV	15.36mA
Accuracy	± 1.0% of (Setting + Range)			
Constant Voltage Mode + Constant Power Mode				
Range	1200V	20000W	1200V	24000W
Resolution	20mV	320mW	20mV	384mW
Accuracy	± 1.0% of (Setting + Range)			
Surge Test				
Surge & Normal current	0~800A		0~960A	
Surge time	10~1000ms			
Surge step	1~5			
MPPT Mode				
Algorithm	P & O			
Load mode	CV			
P&O interval	1000ms~60000ms ; resolution 1000ms			
Dynamic Mode				
Timing				
Thigh & Tlow	0.010~9.999 / 99.99 / 999.9 / 9999mS			
Resolution	0.001 / 0.01 / 0.1 / 1mS			
Accuracy	1μS/10μS/100μS/1mS + 50ppm			
Slew rate	0.0352A ~ 2.2A/μS	0.352A ~ 22A/μS	0.0384A ~ 2.4A/μS	0.384A ~ 24A/μS
Resolution	0.0088A/μS	0.088A/μS	0.0096A/μS	0.096A/μS
Accuracy	± (5% of Setting) ±10μS			
Current				
Range	0 ~ 80A	80 ~ 800A	0 ~ 96A	96 ~ 960A
Resolution	1.28mA	12.8mA	1.536mA	15.36mA
Measurement				
Voltage Read Back				
Range (5 Digital)	0 ~ 120V	120 ~ 1200V	0 ~ 120V	120 ~ 1200V
Resolution	2mV	20mV	2mV	20mV
Accuracy	± 0.025% of (Reading + Range)			
Current Read Back				
Range (5 Digital)	0 ~ 80A	80 ~ 800A	0 ~ 96A	96 ~ 960A
Resolution	1.28mA	12.8mA	1.536mA	15.36mA
Accuracy	± 0.05% of (Reading + Range)			
Power Read Back				
Range (5 Digital)	20000W		24000W	
Accuracy ⁴	± 0.06% of (Reading + Range)			

General		
Typical Short Resistance	0.0188Ω	0.0157Ω
Maximum Short Current	800A	960A
Load ON Voltage	1 ~ 250V	
Load OFF Voltage	0 ~ 250V	
Power Consumption	1700VA	
Dimension(H x W x D)	886.6mm x 481mm x 757.3mm	
Dimension(H x W x D) (Not included Rack Mount Kit)	886.6mm x 445.2mm x 757.3mm	
Dimension(H x W x D) (Not included Rack Mount Kit, wheels)	782.6mm x 445.2mm x 757.3mm	
Weight	140.5KG	155KG
Temperature ^{*5}	0~40°C	
Safety & EMC	CE	

^{*1} The power rating specifications at ambient temperature = 25 °C
^{*2} The range is automatically or forcing to range II only in CC mode
^{*3} If the operating current is below range 0.1%, the accuracy specification is 0.1% F.S.
^{*4} Power F.S. = Vrange F.S. x Irange F.S.
^{*5} Operating temperature range is 0~40°C, All specifications apply for 25 °C±5 °C, Except as noted
^{*6} If the operating voltage is higher than 600V, the accuracy specification is 0.5% F.S.

Certificate Of Compliance

We

GOOD WILL INSTRUMENT CO., LTD.

declare that the CE marking mentioned product

satisfies all the technical relations application to the product within the scope of council:

Directive: EMC; LVD; WEEE; RoHS

The product is in conformity with the following standards or other normative documents:

© EMC	
EN 61326-1	Electrical equipment for measurement, control and laboratory use -- EMC requirements
Conducted & Radiated Emission EN 55011 / EN 55032	Electrical Fast Transients EN 61000-4-4
Current Harmonics EN 61000-3-2 / EN 61000-3-12	Surge Immunity EN 61000-4-5
Voltage Fluctuations EN 61000-3-3 / EN 61000-3-11	Conducted Susceptibility EN 61000-4-6
Electrostatic Discharge EN 61000-4-2	Power Frequency Magnetic Field EN 61000-4-8
Radiated Immunity EN 61000-4-3	Voltage Dip/ Interruption EN 61000-4-11 / EN 61000-4-34
© Safety	
EN 61010-1 :	Safety requirements for electrical equipment for measurement, control, and laboratory use - Part 1: General requirements

GOODWILL INSTRUMENT CO., LTD.

No. 7-1, Jhongsing Road, Tucheng District, New Taipei City 236, Taiwan

Tel: [+886-2-2268-0389](tel:+886-2-2268-0389)

Fax: [+886-2-2268-0639](tel:+886-2-2268-0639)

Web: <http://www.gwinstek.com>

Email: marketing@goodwill.com.tw

GOODWILL INSTRUMENT (SUZHOU) CO., LTD.

No. 521, Zhujiang Road, Snd, Suzhou Jiangsu 215011, China

Tel: [+86-512-6661-7177](tel:+86-512-6661-7177)

Fax: [+86-512-6661-7277](tel:+86-512-6661-7277)

Web: <http://www.instek.com.cn>

Email: marketing@instek.com.cn

GOODWILL INSTRUMENT EURO B.V.

De Run 5427A, 5504DG Veldhoven, The Netherlands

Tel: [+31-\(0\)40-2557790](tel:+31-(0)40-2557790)

Fax: [+31-\(0\)40-2541194](tel:+31-(0)40-2541194)

Email: sales@gw-instek.eu

GPIB programming Example

C Example Program

```
/* Link this program with appropriate *cib*.obj. */  
/* This application program is written in TURBO C 2.0 for the IBM  
PC-AT compatible. The National Instruments Cooperation (NIC)  
Model PC-2A board provides the interface between the PC-AT and  
a PRODIGIT MPAL ELECTRONIC LOAD. The appropriate  
*cib*.obj file is required in each program to properly link the NIC  
board to C LANGUAGE. and include the <decl.h> HEADER FILE  
to C LANGUAGE. */
```

```
#include <stdio.h>  
#include <dos.h>  
#include <math.h>  
#include "decl.h"      /* NI GPIB CARD HEADER FILE */
```

```
main()  
{  
    char ouster[20],rdbuf[15],spec[10];  
    int i,ch,load;  
    /* Assign unique identifier to the device "dev5" and store in  
variable load. check for error. ibfind error = negative value  
returned. */  
    if((load = ibfind("dev5")) < 0) /* Device variable name is load  
*/  
    {  
        /* GPIB address is 5*/  
        printf("\r*** INTERFACE ERROR ! ***\a\n");  
        printf("\r\nError routine to notify that ibfind failed.\n");  
        printf("\r\nCheck software configuration.\n");  
        exit(1);  
    }  
}
```

```

/* Clear the device */
if((ibclr(load) & ERR);
{
    printf("INTERFACE ERROR ! \a");
    exit (1);
}
clrscr();
/* Clear load error register */
{
    outstr=chan[0];
    ibwrt(load,outstr,6);
    ibwrt(load,"CLR",3);
}

    ibwrt( load,"NAME?",5);                /* Get the PEL-5000C
series load specification */
    strset(rdbuf,'\0');                    /* Clear rdbuf string
buffer */
    strset(spec,'\0');                    /* Clear spec string buffer
*/
    ibrd(load,spec,20);
    if (spec[3] == '9')
        printf("\n PEL-5000C series specification error !");
/* Set the channel 1, preset off, current sink 1.0 amps and load on
commands to the load. */
    ibwrt( load,"chan 1;pres off;curr:low 0.0;curr:high 1.0;load on
",43);
    ibwrt( load,"meas:curr ?",10);
/* Get the load actually sink current from the load */
    ibrd( load,rdbuf,20);
/* go to local. */

```

```
    ibloc(load);  
}
```

BASICA Example Program

LOAD DECL.BAS using BASICA MERGE command.

```
100 REM You must merge this code with DECL.BAS  
105 REM  
110 REM Assign a unique identifier to the device "dev5" and store it  
    in variable load%.  
125 REM  
130     udname$ = "dev5"  
140     CALL ibfind (udname$,load%)  
145 REM  
150 REM Check for error on ibfind call  
155 REM  
160     IF load% < 0 THEN GOTO 2000  
165 REM  
170 REM Clear the device  
175 REM  
180     CALL ibclr (load%)  
185 REM  
190 REM Get the PEL-5012C-600-840 load specification  
195 REM  
200     wrt$ = "NAME?" : CALL ibwrt(load%,wrt$)  
210     rd$ = space$(20) : CALL ibrd(load%,rd$)  
215 REM  
220 REM Set the preset off, current sink 1.0 amps and load on  
    commands to the load.  
225 REM  
230     wrt$ = "pres off;curr:low 0.0;curr:high 1.0;load on"
```

```
240     CALL ibwrt(load%,wrt$)
245 REM
250 REM Get the load actually sink current from the load
255 REM
260     wrt$ = "meas:curr?" : CALL ibwrt(load%,wrt$)
270     rd$ = space$(20) : CALL ibrd(load%,rd$)
275 REM
280 REM Go to local
285 REM
290 CALL ibloc(load%)

2000 REM Error routine to notify that ibfind failed.
2010 REM Check software configuration.
2020 PRINT "ibfind error !" : STOP
```

PEL-5000C series USB Instruction

Background

1. Install the USB DRIVER select
USB\SETUP\PL-2303 Driver Installer.exe

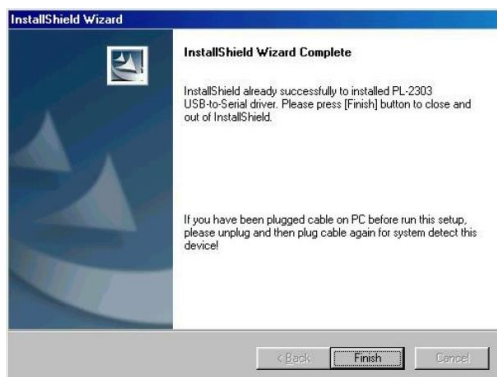
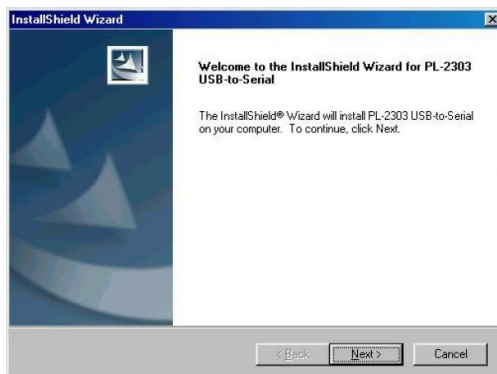

2. After the installation, connect the PEL-5000C series and PC with USB. Then select the item USB to Serial Port (COM3), set the BAUD-RATE and Flow control to 115200bps and Hardware to control PEL-5000C series with COM3.

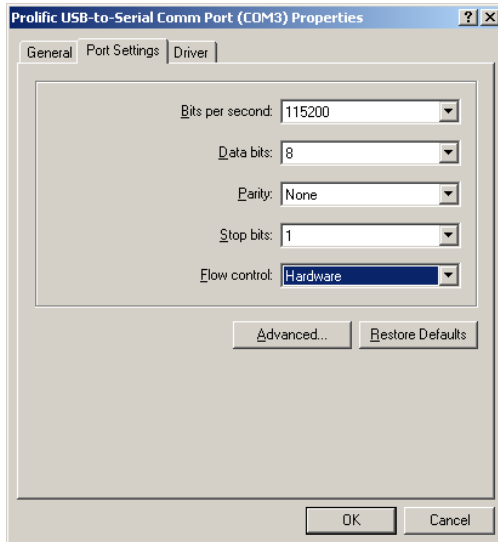
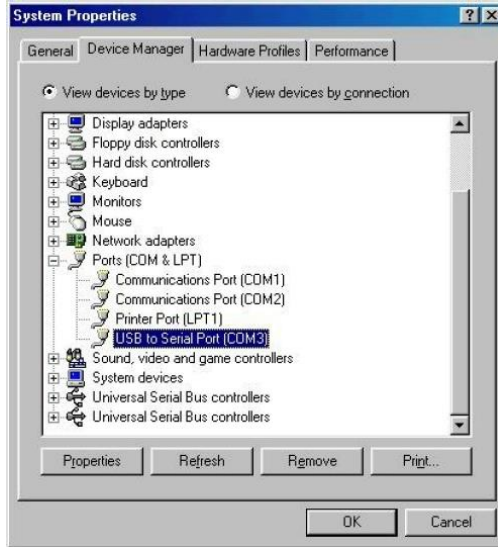

PEL-5000C series Auto-Sequence function provide EDIT, ENTER, EXIT, TEST and STORE 5 keys operation

- | | |
|-----------|---|
| Edit mode | <ol style="list-style-type: none">1. Set mode, Range, current level ... Load Setting an, Load ON.2. Press STORE key to store the load setting in memory STATE3. Repeat 1~2, for the sequence load setting.4. Press Shift + SEQ. key of PEL-5000C Series front panel.5. Press up/down key to select Edit Mode.6. Press 1~9 number key program number.7. Press STATE up/down key to select memory state.8. Press ENTER to next step.9. Repeat 6~8 to edit Step of sequence10. Press SAVE to confirm the step11. LCD shows "rept" to setting repeat count.12. Press up/down key to set repeat count of sequence loop.13. Press ENTER to confirm the sequence edit. |
| Test mode | <ol style="list-style-type: none">1. Press Shift + SEQ. key of PEL-5000C series front panel.3. Press up/down key to select Test Mode.4. Press 1~9 number to select sequence number5. Press ENTER to execution the sequence6. The LCD shows "PASS" or "FAIL" after testing. |

AUTO SEQUENCE:

AUTO SEQUENCE SET COMMAND	NOTE	RETURN
FILE {SP} {n}{ ; NL}	n=1~9	1~9
STEP {SP} {n} { ; NL}	n=1~16	1~16
TOTSTEP {SP} {n}{ ; NL}	Total step n=1~16	1~16
SB {SP} {m} { ; NL}	m=1~150 m:STATE	
TIME {SP} {NR2} { ; NL}	100~9999(ms)	100~9999(ms)
SAVE { ; NL}	Save "File n" data	
REPEAT {SP} {n} { ; NL}	n=0~9999	0~9999
RUN {SP} {F} {n} { ; NL}	N=1~9	AUTO REPLY "PASS" or "FAIL:XX" (XX=NG STEP)

Example Sequence

In this example, we will create a program based on following Figure.

The program repeats steps 1 to 8 two times. After repeating the sequence two times, the load is turned off and the sequence ends.

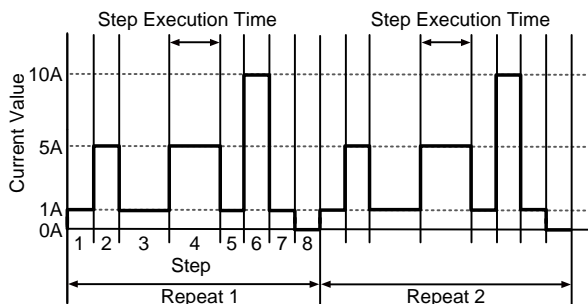

Sequence Number	Step Number	Current Value	Execution Time(T1+T2)
3	1	1A	200mS
3	2	5A	200mS

3	3	1A	400mS
3	4	5A	400mS
3	5	1A	200mS
3	6	10A	200mS
3	7	1A	200mS
3	8	0A	200mS

Example
Sequence

1. Setting the Load current level and store to state 1~8
2. Set the operation mode
Press the mode key to CC mode.
3. Set the range
Press RANGE key to force range 2
4. Press Load ON
5. Set the current value as step 1~8 and store to memory state 1~8
6. Press EDIT key of PEL-5000C series mainframe
7. Press up/down key to select Edit Mode
8. Press sequence number 3 to edit the sequence.
9. Press up/down key to memory state 1
10. Press ENTER key to confirm the sequence memory
11. Press up/down key to setting execution time
12. Press ENTER key to confirm the sequence step
13. Repeat 8~12 to setting step 1~8
14. Press SAVE key to confirm step 1~8
15. Press up/down key to 1 to repeat one times.
16. Press ENTER to confirm the repeat count.

Testing Waveform

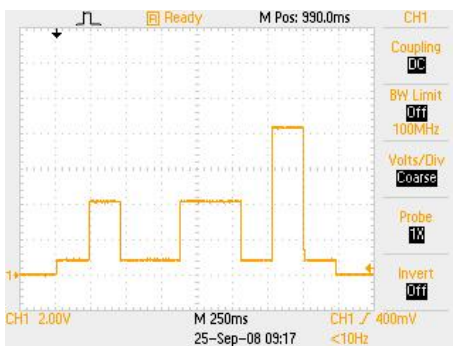

PEL-5000C series LAN Instruction

Background

1. Connecting AC power and the network line to the PEL-5000C series mainframe, connect the other Side of the network line to the HUB.
 - a. For Windows XP:

Run the ETM.EXE (This file can be downloaded from GW Instek website), it will show as fig below. If not, please press F5 to search again, or check the first step was succeed or not.

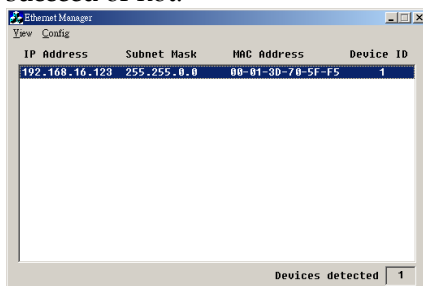

- b. For Windows 7, 8 and 10:

Run the IPScanner.EXE (This file can be downloaded from GW Instek website), If a Windows security alert appears, please select a public network, and then click "Allow Access", the following screen will appear. if not , please press F5 to search again, or check the first step was succeed or not.

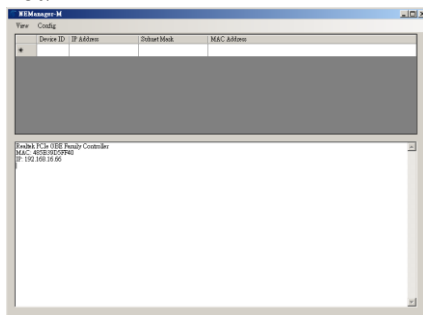

2. It will be shown the installation which has been searched on the screen, click it and select the Set IP Address bellows Config:

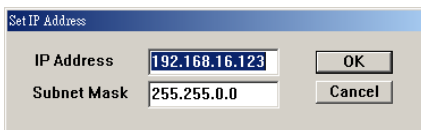

3. Set a useful IP Address and Subnet Mask.
4. It will be shown the Setup Device as the following figure if all steps was corrected to be run.

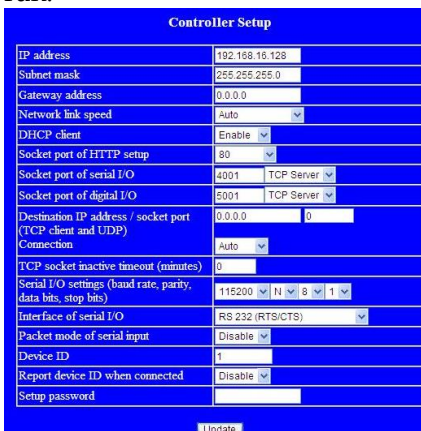

5. Insert the numbers as the following:
 - A. Subnet Mask: as recommended according to your network
 - B. Gateway Address: as recommended according to your network
 - C. Network link speed: Auto
 - D. DHCP client: Enable
 - E. Socket port of HTTP setup: 80
 - F. Socket port of serial I/O: 4001, TCP Server

- G. Socket port of digital I/O: 5001, TCP Server
- H. Destination IP address/ socket port (TCP client and UDP) Connection: Auto
- I. TCP socket inactive timeout (minutes): Set the network disconnection after N minutes, set 0 minutes will work forever.
- J. Serial I/O settings (baud rate, parity, data, bits, stop bits): 115200, N, 8, 1
- K. Interface of serial I/O: RS 232 (RTS/CTS)
- L. Packet mode of serial input: Disable
- M. Device ID: 5
- N. Report device ID when connected: Auto
- O. Setup password: Not required